



Hydraulic Hoses, Fittings and Equipment

Catalogue



ENGINEERING YOUR SUCCESS.

Contents

Introduction		2 – 33
Technical handbook		
Crimp systems you can trust	A	2 – 5
Hoses and fittings terminology – the basics	Aa	2 – 8
Safe hose assemblies – working steps	Aa	9 – 19
How to order (Part Number description)	Aa	20 – 21
Identifying fitting types	Aa	22 – 29
Storage – Hoses and hose fittings	Aa	30 – 31
Safety first! – Parker safety guide	Aa	32 – 38
Technical data	Ab	2 – 34
Low Pressure Push-Lok		
Push-Lok Hoses	B1a	1 – 10
Fittings 82 series	B1b	1 – 18
Assembly Instructions	B1b	19
Low Pressure Transportation and Hydraulic		
Low Pressure Hoses	B2a	1 – 10
Fittings 26 series	B2b	1 – 7
Medium Pressure		
GlobalCore Parkrimp No-Skive Hoses	Caa	1 – 9
Parkrimp No-Skive Hoses	Cab	1 – 39
Fittings 43 series	Cb	1 – 15
Fittings 46 and 48 series	Cc	1 – 42
Fittings 2piece 48 series	Cd	1 – 2
Fittings 2piece IF series	Ce	1 – 3
High Pressure		
GlobalCore Parkrimp No-Skive Hoses	Daa	1 – 9
Parkrimp No-Skive and ParLock Skive Hoses	Dab	1 – 33
Fittings 70 series	Db	1 – 18
Fittings 73 series	Dc	1 – 20
Fittings 77 series	Dd	1 – 25
Fittings VS series	De	1 – 15
Fittings V4/V6 series	Df	1 – 25
Fittings V5 series	Dg	1 – 3
Fittings WB series	Dh	1 – 4
Machines, Tooling, Accessories		
Machines	Ea	1 – 33
Accessories	Eb	1 – 24
Assembly Instructions	Ec	1 – 2
Your Crimp Source online	Ed	1

Technical handbook

Low Pressure Push-Lok

The intelligent Push-Lok System covering different types of rubber, thermoplastic as well as a hybrid hose version and a wide selection of reusable fittings made of steel, brass and stainless steel.

Pressure range
up to 2.8 MPa

Low Pressure Transportation and Hydraulics

This low pressure range follows the No-Skive concept and the majority can be assembled on Parkrimp machines.

Pressure range
up to 20.7 MPa

Medium Pressure

Hose and fitting product range for applications in mobile and industrial hydraulics.

The perfect range for the more demanding market requirements with a broad selection of Parkrimp No-Skive fittings, with over sixty end configurations, combined with Parker hoses and crimpers allows simple and safe assembly – whenever and wherever needed.

Pressure range
up to 45.0 MPa

High Pressure

Heavy-duty products for heavy-duty applications with a full range of Parkrimp No-Skive multispiral hoses and fittings and ParLock skive type hoses and fittings.

Pressure range
up to 69.0 MPa

Machines, Tooling, Accessories

The perfect complement to the largest range of hoses and fittings in the market. Parker crimping technology is recognised throughout the industry as the easiest and most accurate crimping system available.

SOLVING THE WORLD'S GREATEST ENGINEERING CHALLENGES.

Our focus on solving some of the world's greatest engineering challenges sparks our passion for innovation and secures our future growth.

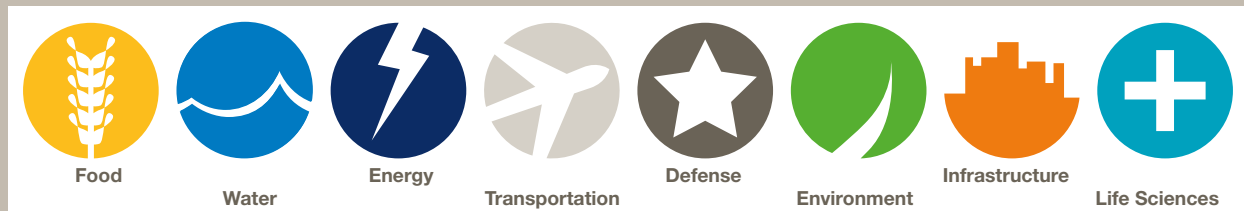

The development of more efficient energy sources; the desire to produce and distribute clean water; new drug discovery and medical advances; the building of infrastructure and transportation to support a growing population; the safe cultivation, transportation and preservation of food sources; emerging developments in defense; and the protection of our environment – all of these challenges drive Parker people forward, seeking new ways to innovate, combine technologies, collaborate, develop systems and partner with our customers to solve problems.

ENGINEERING YOUR SUCCESS.

It's more than a tagline – it's an anchor that ensures our progress is grounded in the principles that have made our company a success. The Parker brand represents a promise backed by 57,000 team members to improve our customers' productivity and profitability.

Our success is achieved in partnership with our customers and distributors in 50 countries who extend our reach with the same goals to innovate, improve efficiencies and create intelligent solutions.

PARKER HANNIFIN – THE GLOBAL LEADER AND YOUR PARTNER

Parker provides an unparalleled range of products and solutions in an array of diversified industrial and aerospace markets.

We are always exploring new ways to enhance our manufacturing processes and tools, testing capabilities and research and development.

The Parker Technology Center advances enterprise-wide priorities while our operating group centers focus on specific technologies. This strategy offers the best of both worlds: traditional product and application engineering supplemented with advanced design and manufacturing processes.

Our technical fellows and subject matter experts are supported by a large number of engineers and specialists with advanced degrees and training.

Regular and consistent training and problem solving techniques enable high performance teams to make a significant impact across the business.



PARKER CORE TECHNOLOGIES





Hose Products Division Europe

The market leader and your supplier of choice.



Put a bite on the braid.

Parker's world-recognized tiger mascot has represented the Parkrimp No-Skive hose assembly program since its introduction in 1980. In a contest originally held by our marketing department, the tiger was the winning suggestion over three others: a turtle (deemed "too slow"), an alligator ("not very good looking") and a shark ("too intimidating" particularly at the time of the release of the movie Jaws).

More than three decades later, the tiger graphic still supports the Parkrimp message everywhere, clearly symbolizing our unique, patented Parkrimp fittings with tapered steel teeth and our Parkrimp crimping machines. Their ability to eliminate hose cover skiving and achieve the metal-to-metal grip of factory assemblies revolutionized the process for markets worldwide. And today, it's the industry standard.

Pride in our products: At Parker, we believe the best fluid connector products for your operation are the ones that get the job done right. We offer the most comprehensive line of hoses, fittings, equipment and accessories you'll need. And if there's something you need that's not a standard product, we're able to design and manufacture it for you with ease.

You'll also benefit from our ultimate competitive advantage – our network of distribution outlets that can provide our products nearly anytime and anywhere. We strive to provide customers with local engineering, local products and local service.

Parker offers the largest selection of hoses plus more fitting sizes than any other manufacturer. You'll find a wide variety of hoses including braided, spiral and multi-purpose, and more than 4,500 Parkrimp fittings. Parker products have been designed, tested and approved to meet and exceed global standards.



The right product is available for your application, including hose that features a variety of abrasion resistant cover choices, flexibility, a wide range of media compatibility and more – characteristics that make Parker the hose supplier of choice for customers that demand the most from their equipment.



A long history of providing premier customer service.

Our plant in Veniano, Italy is our precision-engineered-solution center for products, materials and processes, and is equipped with state-of-the-art development, testing and perfor-

mance technology. All manufacturing locations our hose products division provide a quality product on time. Knowing that uptime and productivity are major drivers in your business

success, we proudly present this catalog outlining Parker's best-in-class hose products and services.



Low, Medium, High and Ultra Pressure Hose



Parkrimp® Hose Fittings



Parkrimp® Assembly Equipment

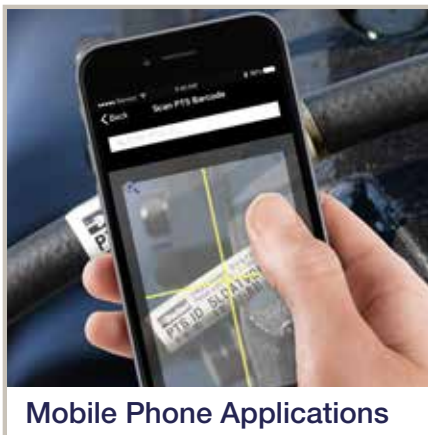

Mobile Phone Applications



Parker Tracking System

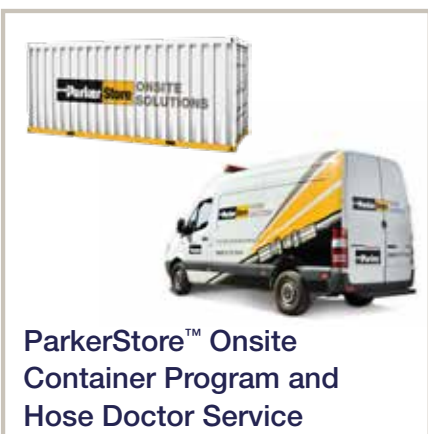

ParkerStore™ Onsite Container Program and Hose Doctor Service



Custom Hose Assemblies and Hose Fittings



Accessories

Good – Better – Best – engineered for your success.

The classification for easier hose and fitting selection



Parker Hose Products Division Europe supplies premier service by focussing on customer needs. To engineer customer's success by offering diversified products, we introduce a "Good, Better, Best" classification according to the quality standards and in line with the requirements of the individual applications.

Customer's choice is the key.

Good

BCH medium and **SX** high pressure hoses – meeting international technical standards – developed for demanding small and medium OEMs and general distribution.

Medium Pressure

BCH1
BCH2

Fitting Series



High Pressure

SX35
SX42

Fitting Series



* MP (Multipack) only

Better

Well known *Elite No-Skive* medium and **Parkrimp**® *No-Skive* high pressure hoses – exceeding the standards – highly appreciated in the very demanding MRO and OEM markets.

Medium Pressure

Elite
462, 492

Fitting Series



High Pressure

Parkrimp
701, 731

Fitting Series



Best

State-of-the-art **GLOBALCORE**™ hose product range – exceeding the newest ISO 18752 – providing technical and economical excellence to the most demanding customers.

Medium Pressure

GLOBALCORE™
387, 487

Fitting Series



High Pressure

GLOBALCORE™
787, 797

Fitting Series



Customers choice is the key

Good, Better, Best classification for easier hose and fitting selection

- Different levels for different markets and applications
- Help customers to make better buying decision
- Defined hose and fitting combination on hose layline
- Clear visibility of correct fitting
- Easy to understand
- Ensures quality of hose and fitting combination

Superior performance of Best hoses versus Better and Good hoses

- Bend radius up to 50% smaller
- Flexibility (bending force) up to 30% higher
- Weight up to 20% lower
- Dimensions up to 25% smaller area
- Impulse resistance and service life up to four times higher
- Working temperature up to 25% higher

Especially developed Good hoses

- Medium pressure **Good** hose types BCH1, BCH2 with the fitting series 46 and 48
- High pressure **Good** hose types SX 35 and SX 42 with fitting series 73 and 77



GlobalCore™

The world's first high-performance, cohesive hose and fitting system.

Providing a simple solution of robust hydraulic hoses designed to endure the tough conditions where work gets done, GlobalCore is the future that OEMs and end users around the world have been asking for.

You know Parker as the global leader in providing unprecedented performance and value for hydraulic systems with high-pressure applications. With our GlobalCore solution, you can significantly reduce your inventory and part number complexity by using just five hoses and two fittings.

Designed to meet the most common working pressures in industry, GlobalCore stands above the competition and serves customers around the world with a simple family of constant working pressure hoses.

Designed, built and tested to the ISO 18752 specification, GlobalCore reduces engineering and service complexity by providing the first comprehensive product family across the most commonly used constant working pressure classes.

Hoses	-4	-6	-8	-10	-12	-16	-20	-24	-32	-40	-48
7 MPa / 1,000 psi										187	187
21 MPa / 3,000 psi	387	387	387	387	387	387	387	387	387		
28 MPa / 4,000 psi	487	487/722	487/722	487/722	487/722	487/722	487	487	487		
35 MPa / 5,000 psi	787	787	787	787	787	787	787	787	787		
42 MPa / 6,000 psi	797	797	797	797	797	797	797	797	797		

Fittings	-4	-6	-8	-10	-12	-16	-20	-24	-32	-40	-48
7 MPa / 1,000 psi										2piece 48	2piece 48
21 MPa / 3,000 psi	43/48	43/48	43/48	43/48	43/48	43/48	43/77	77	77		
28 MPa / 4,000 psi	43/48	43/48	43/48	43/48	43/48	43	77	77	77		
35 MPa / 5,000 psi	43/48	43/48	77	77	77	77	77	77	77		
42 MPa / 6,000 psi	43/48	43	77	77	77	77	77	77	77		

High Performance

Because challenges can emerge anytime and anywhere, your solution should endure the tough conditions of your work environment.

The high-performance standards designed, engineered and manufactured into GlobalCore provide the longest service life possible.

With GlobalCore hoses tested to twice the ISO 18752 standard, high performance in rugged environments and high-impulse applications is ensured.

Additional value is realized through:

- 100 °C / 125 °C temperature ratings
- Standard, ToughCover and SuperTough cover technologies for abrasion resistance
- ½ minimum bend radius (beside hose 187)
- Low force to flex for ease of installation
- Advanced inner tube chemistry



Any Pressure. Any Project. One Solution.

Cohesive

GlobalCore is a unified system that delivers hoses designed, built and tested to the ISO 18752 specification. GlobalCore expands our range of ISO 18752 hoses and provides options for the most critical sizes and pressure ranges – 7.0 MPa (1,000 psi) to 42.0 MPa (6,000 psi) in sizes -4 through -48 (hose 187 in size -40 and -48 only).

Simple

The GlobalCore system is simple. With only six hoses, OEM and MRO customers alike will enjoy selecting the right hose based on working pressure. Selecting the fitting is even simpler. Choose the world renowned 43/48 Series, with more than 2,500 configurations, or the 77 Series, designed specifically for higher pressure applications and available in more than 500 configurations.

Cover Options

GlobalCore hoses come with a variety of cover options so you can match the right cover to your application.



Standard



Tough



Super Tough

Global

A single cohesive family of complimentary products so qualified has never before been offered globally. Produced with the same performance and manufacturing specification in production plants located in all the continents, GlobalCore can support your hydraulic hose needs regardless of where your equipment was originally manufactured or is today.

Global Approvals

GlobalCore will carry the most common international classification body type approvals as requested by our customers. ABS, DNV, Lloyd's Register, MSHA and USCG will be comprehensive approvals, while other certifications will be specific to designated hoses or sizes.



Visit parkerglobalcore.com for the latest list of hose and classification body type approvals.



It's so easy to crimp your own hose assemblies whenever you need them

Parkrimp® *No-Skive*

The system for fast and leak-free hose assemblies with No-Skive one-piece fittings

Hose fittings have an impact on the overall efficiency and safety of a hydraulic system. The No-Skive concept was launched by Parker Hannifin some 30 years ago but continuous development and the use of modern materials and production techniques have resulted in a state-of-the-art hose to fitting connection. Much easier handling and a high level of safety are available with No-Skive crimp fittings. Parker offers No-Skive fittings in one and two pieces as part of a package consisting of quality hose, No-Skive fittings, hose crimpers and tooling.

- No skiving tool needed
- No need to remove the cover
- Crimps one-piece fittings
- Parkalign positions the fittings in the dies perfectly every time
- Quick and easy – no gauges to set on the machine
- Portable machines for field repair
- Meets EN safety regulations



KarryKrimp® 1
82CE-061L



KarryKrimp® 2
85CE-061L



Parkrimp® 2
83CE-083U

Modular crimpers with bench power unit for workshops

The modular design enables the customer to choose between the portability that Parker KarryKrimp crimpers have always offered, and the option to make these same crimpers bench mount units.

In addition to the portable versions, the sole crimping units can be used with the Bench Power Unit for workshop versions for faster cycle times, increased productivity and increased height for longer elbows or bent tube fittings.



KarryKrimp® 2 Bench Mount
85CE-061L + 85CE-1PE

Please visit us also at
www.easy-crimping.com



ParLock – the complete Big Bore solution

No-Skive™ and ParLock Skive technology

In addition to the new R35TC-40, already launched and very well accepted in the market, Hose Products Division Europe follows its strategy to develop a complete Big Bore hydraulic hose range. Four different hose types are available to fulfil all high flow rate hydraulic needs for markets like oil & gas, mining and heavy duty constructions.



R35TC-40 and RS35TC-48

R35TC-40 and RS35TC-48

- Very high working pressure of 35.0 MPa (5000 psi)
- High abrasion resistant **TOUGH COVER** prolongs hose life, minimizes downtime and eliminates extra cost for additional protection sleeves – MSHA approved
- Approved with Interlock V6 series fittings, connection types: ISO 6162-2 (42.0 MPa/6000 psi)

R35TC-40

- Design factor of 4:1
- Impulse tested to more than 1.5 million cycles at +120 °C
- Extra strong 6-spiral construction for high-flex-impulse and high-vibration applications
- **NEW:** ISO 6162-2 (42.0 MPa/ 6000 psi) flange

RS35TC-48

- Design factor of 2.5:1 according ISO 6708-D
- Extra strong 6-spiral construction for high-vibration applications

For heavy duty applications, both sizes -40 (63.5 mm) and -48 (76 mm), based on Interlock technology, will complete the existing ParLock range and is now available from size -4 to -48.

Due to the severe applications, both hoses are coming with TC cover for best abrasion resistance and MSHA approved. Due to the enhanced hose diameters and in combination with very high pressures, flow rates can be increased – this eliminates the need of numerous pressure lines and results in a cost reduction for connectors. Today, all 6000 psi flanges are available and SteckO® fittings can be used for mining applications.



462TC-40/462TC-48

For low pressure and return lines, Parker extended the very well known Elite Compact range with the new 2SC hose type 462TC – available **now** from size -4 to -48.

In order to reach a 7.0 MPa working pressure with Elite Compact hose 462TC in both sizes -40 and -48, Parker developed a brand new Big Bore fitting which will complete the well known 48 series.

462TC-40 and 462TC-48

- No-Skive hose construction – Compact design
- Nitrile (NBR) inner tube – extended fluid compatibility
- Exceeding EN/ISO specifications for pressure, bend radius and abrasion resistance
- Highly abrasion resistant **TOUGH COVER**, MSHA approved
- WP 7.0 MPa with 4:1 design factor – Dynamic application, impulse tested
- High flexibility in spite of big size
- 2piece fittings for use with adjustable crimper only (47 series nipple and 10048 shell)

Hoses for the Oil & Gas market

Quality, reliability, consistency and service!

The Parker blowout preventer (BOP) hose system is a vital part of exploration and drilling equipment in the very demanding oil & gas market. Optimum performance with the highest safety is the main aspect. Especially the high quality compounds of BOP hoses such as ParLock FA35 – all made in Europe – and the assembly process of the components guarantees our customers the highest flexibility and the easiest installation on site. Parker BOP hose system has been tested and approved according to API 16D standard by Lloyds Register. The BOP hose system is supplemented by a wide range of hoses and fittings for rotary drilling application, e.g. hose types RD35TC and CEM69TC.

CEM69TC is a multispiral hose with six spirals and dedicated for cementing hose applications with flexible connection between the cementing pump manifold and cementing head for conveyance of cement slurries at high pressure up to 69.0 MPa. CEM69TC is tested and approved by DNV according to API 7K.

RD35TC – Rotary drilling hose available in sizes -32, -40 and -48, designed to work at 35.0 MPa constant working pressure with fluids made of mud, cement and oils used in various drilling operations. DNV has certified the compliance of RD35TC range to API 7K grade D, FLS2 specification.



FA35 is a hose range from size -10 to -32 with constant working pressure of 35.0 MPa, used in a very delicate hydraulic circuit that operates the blowout preventer security mechanism to shut down the well in case of need.

FA35 has successfully passed very tough flame test of API 16D (hose under 35.0 MPa exposed for min. 5 minutes to flame 700 °C) and has been certified by Lloyd's Register according to this norm.

**All these certified matching systems,
let you work safer, smarter, faster and better.**



Parker Blastopak

New hose range for water-blasting applications

Choose the improved performance of Parker Blastopak hose

Parker's Blastopak range is an offer of hoses with four or six spirals that better meets the requirements of water-jetting and blasting applications. High-pressure water-blasting hoses are widely used for many industrial applications like water cutting, cleaning and removal of corrosion or paint or other kinds of materials.

In water-blasting applications, ultra-high pressure systems are commonly used, where the safety and robustness of a product are essential.

Parker's range of Blastopak hoses is the ideal solution for these kinds of applications. With its high working pressure from 800 bar (80 MPa) in size -16 up to 1100 bar (110 MPa) in size -6 to -12, good flexibility combined with dedicated interlock fittings is the right choice to ensure better performance and safety at the same time.

Design factor burst/working pressure of 2.5:1; the product meets the requirements of global specification DIN EN 1829/2 (impulse) in all common hydraulic applications.



High-performance PU-cover rubber hoses

The fusion of two worlds in one

Parker rubber hoses with polyurethane cover – the range for the future with outstanding properties

With hoses 462PU, 692PU and 837PU-Plus, Parker has realised the combination of synthetic rubber and polyurethane. Due to the manufacturing process and the two materials, these hoses reach new dimensions in terms of quality and product properties, e.g. a design factor of 4:1 for 462PU and 692PU.

462PU

Type 462PU is a compact, medium pressure hydraulic hose with two steel wire braids and a working pressure from 28.0 MPa up to 42.5 MPa.

Types 462PU and 692PU have been specially developed to meet the challenges of over-the-sheave applications of twin hose. This is why their main applications are forklift masts, telehandlers and materials handling equipment.



692PU

Type 692PU is also a compact medium pressure hydraulic hose with one or two steel wire braids and a constant working pressure of 21.0 MPa.



837PU-Plus

Type 837PU-Plus is a low pressure Push-Lok hose with a braided reinforcement made of high-strength textile fibres. The preferred applications of type 837PU-Plus

include cooling circuits and compressed air in hose bundles and energy chains of robots, car production lines, machine tools, injection moulding and PET blow moulding machines.

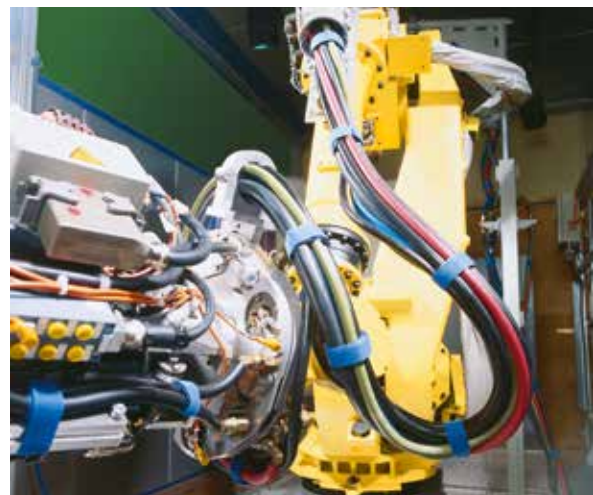

Parker rubber compounds

assuring superior ozone resistance and performance

Ozone – O₃

A molecule consisting of three oxygen atoms is called OZONE (O₃). In the ozone layer this gas protects living organisms against harmful UV-radiation, but also it is a strong oxidant, harmful against the respiratory system of humans and animals.

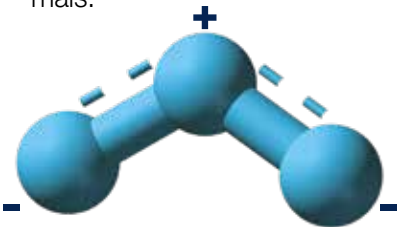

Ozone is highly impacting the degeneration of rubber

Ozone is one of the strongest oxidants. Beside the harms to all organic material it also applies to elastomer compounds, e.g. NBR, CR. Already small concentrations impacting product quality and service life. Moisture intensifies ozone cracking.

The concentration of ozone is rising

Ozone is generated by UV-rays, electrical discharge and air pollution. The natural ozone concentration is highly influenced by local conditions. Since 1971, the beginning of ozone measurements, the values continuously raised by 30% up to now.

Ozone resistance is a must

The polymer chains are split by ozone, leading to cracks growing vertical to the direction of elongation. Even a small amount of elongation ($\leq 10\%$) is required to provoke cracks and increases rapidly with increasing elongation. The cracks, finally reaching the reinforcement of the hose, will cause corrosion and ending up in severe damage. In order to increase hose life, Parker

developed a new series of rubber compounds for Standard cover, Tough cover (TC) and low temperature (LT) hoses.

Parker Elite and multispiral hoses are able to withstand more than **400 hours** 400 hour ozone resistance, following the ISO7326 Ozone Resistance Test. Super Tough (ST) cover hoses pass even more than 800 hours ozone resistance.



ISO 7326 Ozone Resistance Test

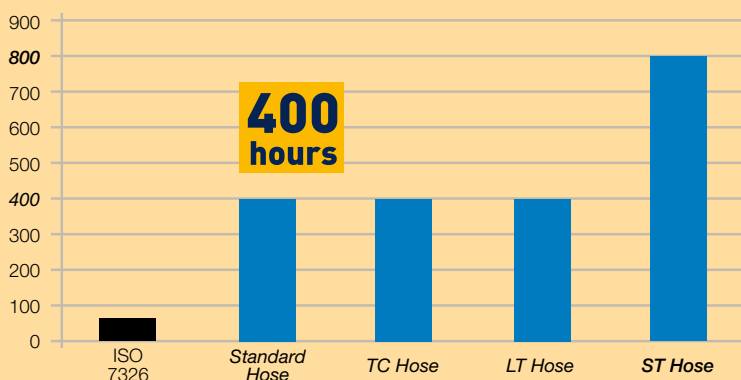

Attention

Ozone resistance is highly influenced by the bending radius (short bend radius = less ozone resistance)

Additional environmental conditions such as chemicals and temperatures may also shorten the hose life!

If your application requires corrosion resistance

state of the art surface protection for hose fittings is the solution

400 hours

Our mandate for continuous improvement leads us to partner with our customers to create smaller, lighter, sustainable, more energy efficient and finally highly reliable solutions. Our goal is thus to provide you with state of the art surface protection for

our standard hydraulic hose fittings in order to withstand the world's most demanding application requirements. In terms of corrosion resistance properties, we decided to follow the needs of our customers and the market and chose improved red corrosion resistance four standard hose fittings.

Parker hose fittings with our chromium 6 free standard plating show a red corrosion resistance of at least **400 hours** of salt spray in a test carried out in accordance with DIN EN 9227.

Chromium-6
Free

Fittings with XTR coating for extreme resistance to corrosion

720 hours

An outstanding advantage for equipment used in highly caustic applications and environments, are Parker fittings with XTR (Extreme-Resistance) coating. This coating withstands corrosion more than seven times longer than the SAE standard of 96 hours. In fact, Parker's proprietary

formulation has been tested to resist corroding for more than **720 hours**. In addition, Parker XTR coating is compliant with environmental restrictions worldwide, including RoHS, ELV and REACH.

Parker products with XTR coating guarantee all the leak-free performance and installation advantages that our customers expect. If your

application requires highly-resistant coating, you can order hose fittings with the extension "ZJ" e. g. **1C348-12-12ZJ**



For special applications in demanding environments stainless steel is the preferred selection

For pneumatic and hydraulic applications in demanding environments, your connection requirements will be met by Parker's range of stainless steel products.

Parker offers a complete system of stainless steel products

such as tubes, tube fittings or 1- or 2-piece hose fittings for low, medium and high-pressure hydraulic hoses – everything from one source and approved by well known international classification bodies. It goes without saying

that Parker's stainless steel components are produced using superior quality stainless steel grade 1.4571, 1.4404, or 1.4401. Thanks to their resistance to corrosion and acids, all components are suitable for tough environments. However, some special applications require special materials and here you can rely on Parker as well – we have the resources to produce customised hose fittings for even the most demanding customer requirements.

Power in Stainless Steel

- Premier customer service
- Single-source solution
- Worldwide availability
- Customized products
- High-quality stainless steel materials
- Complementary design of tube & hose fittings

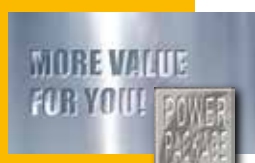

PTS

Parker® Tracking System

Increasing the speed, timing, and accuracy of your next service event.

Parker Tracking System (PTS) is an innovative component-tagging and asset management solution offered by Parker and our business partners in over 62 countries worldwide. Today's equipment and machines are more connected than ever before and harnessing this complex data is key to maximizing up-time. By focusing on critical-wear components, Parker drives new levels of productivity, efficiency, and reliability.

Uptime is Everything

Record, manage and retrieve critical asset information with PTS. This innovative system provides fast and accurate product information, speeding replacement regardless of where or when the original component was created. Because tagged products can be replaced sight unseen, PTS eliminates the need to wait for removal before new parts can be acquired. Reducing transaction time, means users can realize significant gains in productivity and equipment uptime.

Business System Integration

Maintenance, Repair and Operations (MRO) can be greatly enhanced by customizing PTS and integrating it into existing systems. With seamless data integration, Parker enables bi-directional transfer of critical data to maximize asset visibility and performance. For details on supported platforms and protocols, contact a member of our team.

Global Power, Local Reach

PTS works seamlessly around the world. Whether you sell, service or operate products and equipment in one city, one state or worldwide, PTS can be tailored to your needs. Equipment built in one country that is sold and serviced in another can use PTS to deliver accurate product details wherever and whenever they are needed. To support our global footprint, PTS offers translation in multiple languages.



How can something so small do so much?

PTS tags can be customized by the user to contain specific information.

The barcode speeds up the product identification and is about the mobile App controlled.

Every record contains a date code which can drive warranty, inspection, and maintenance activities.

Each asset is tagged with a unique PTS ID number which always guarantees a simple and accurate replacement.



Save valuable time



www.Parker.com/PTS

PTS Mobile

Parker® Tracking System

Advanced asset management...on-the-go!

PTS is one of the industry's most comprehensive and widely distributed asset-tagging and tracking systems, and the PTS Mobile app is the perfect jobsite companion. With millions of tagged assemblies worldwide, you're only a few clicks away to a faster, easier, and more accurate replacement experience.

With You Wherever You Go

Identifying, servicing and replacing critical assets can be a frustrating process. Lost or outdated manuals and complex installations can make identification difficult and time-consuming. Usually, the only solution is to remove the product and take it to a distributor for a replacement.

PTS makes getting replacement components fast, easy, and exact. And now that convenience is available wherever you go with the PTS Mobile app.

Available on Popular Platforms

PTS Mobile is available for Apple and Android devices. Just complete the brief registration form, or log in with your existing PTS credentials. PTS Mobile can also be paired with our OEM or Enterprise application to provide a complete asset management solution for your operation.



Quick Access

Use the new dashboard to get quick access to all of PTS Mobile's most important features.



Registration

Use PTS Mobile to register a growing number of Parker Hannifin products.

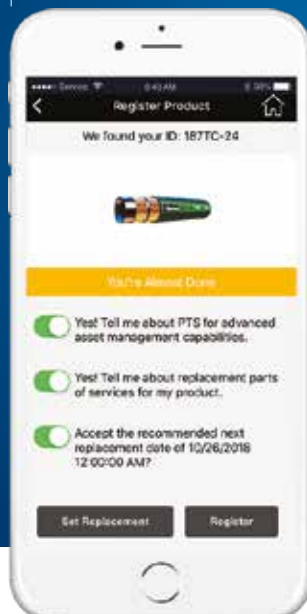

Asset Details

PTS Mobile gives complete details for registered products, and resources to locate distributors.



Where to Buy

PTS Mobile provides mapping and directions to nearby distributors using your smartphone's GPS.



Parker® Tracking System

Track and manage assets with ease

PTS Pro is our most capable offering. PTS Pro brings together advanced asset tracking/management capabilities with Parker's global network of distributors and service partners to provide comprehensive asset management solutions.

Fix When Fail is not a Strategy

Managing equipment or machinery maintenance can be a challenge for even the most capable and well resourced organizations. With hundreds or thousands of individual parts or components that require maintenance, keeping detailed records or maintenance logs can be a burden.

Most asset management systems do not break capital assets down into the detailed components that comprise them. PTS can help.

Global Service Partner

Parker employs a team of dedicated support staff worldwide. Through more than 13,000 service partners and OEMs, Parker can work with customers to provide advanced, on-site audit and maintenance planning services.

This service including:

- On-site asset identification and tagging
- Inspection, maintenance, and replacement
- Site or computer-based training programs



Asset Location

Establish detailed location data for fast and easy replacement.



Asset Inspection

Collecting and storing customizable asset inspection data for easy retrieval.



Scheduled Events

Easily schedule and manage future inspection and replacement dates.



Registration

Register PTS tagged products from our Mobile App.



Asset Geneology

Capture and analyze asset replacement and service history for continuous improvement.



Transfer Records

Seamlessly transfer record visibility between multiple PTS accounts.



Export Details

Quickly export customizable asset reports into Microsoft Excel.



Databooks

Create professional PDF reports containing asset details, service history and attached files.



Digital Documents

Publish and access a variety of digital documentation.



Email Notifications

Receive personal Maintenance, Repair and Operations (MRO) email notifications.

Preventive Maintenance Program

Be preventive ... not reactive!

Hydraulic hose assemblies are essential components in hydraulic systems and each hose assembly will eventually fail: it's just a matter of when!

Broken hose assemblies often cause loss of earning, downtime and serious personal injuries.

Avoiding failures, losses and risks is definitely your first priority.

Preventive maintenance is needed whenever your hose assemblies show:

- Damaged, cracked, cut or abraded cover
- Exposed reinforcement
- Cracked, damaged or corroded fittings
- Leaks in fitting, sweating hose cover close to fitting
- Kinked, crushed, flattened or twisted hose
- Hard, stiff, cracked or burnt hose
- Blistered, soft, degraded or loose cover
- Fitting slippage on hose

Despite that, hose assemblies are generally underrated overlooked during machine servicing and the need of their preventive maintenance and timely replacement is ignored. This is simple a fact which we can hardly change. But what we can do, however is to help you to provide a hose assembly in the right place and at the right time whenever and wherever you'll need it.

As there are countless factors influencing the hose life, there cannot be and are not any exact guidelines to determine when a hose assembly has to be replaced or to judge how long it will work.

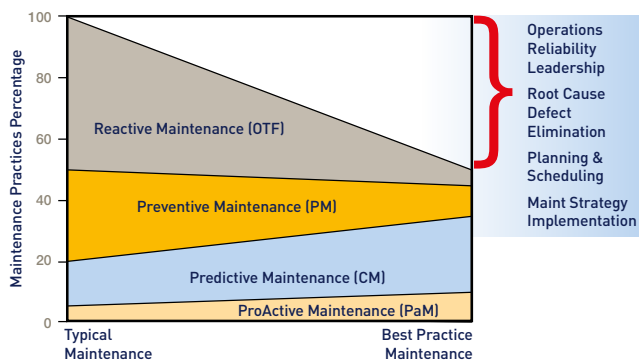

Hint

A good analogy is automobile tyres. Just like hose, tyres are made of rubber, age with time and experience a lot of strain from the conditions they work in. Most drivers are cautious to replace tyres once they show signs of wear, not leaving it to destiny when they break on the road! So why don't they do it with hydraulic hoses?

Yet, we do have a tool to influence and determine the hose life:

**Visual Inspections + Preventive Replacement
= Preventive Maintenance Program!**

Save valuable time



www.Parker.com/PTS

We offer more

Parker Rapid Service Unit

Non standard and customized hose fittings

The Rapid Service Unit (RSU) can provide:

- Jump sizes
- Specific end configurations
- Specific drop lengths
- Fitting/tube combinations
- Customised prototypes
- Any batch size upwards from a single piece

Material options include steel, stainless steel, brass and special materials on request.



*Hose Fitting Design
Center of Excellence*

*Flexible brazing in terms
of design and process*

The Rapid Service Unit (RSU) is part of the Manufacturing Unit Fittings of Hose Products Division Europe and is a dedicated unit for the manufacture of customised and prototype hose fittings.

The unit is responsible for both checking the technical possibilities of the customer request from an engineering perspective as well as establishing the most economic production process. Because of close cooperation between Parker's Manufacturing Units and the Parker Sales Companies (PSC) the Rapid Service Unit (RSU) can live up to its name by reacting, quoting and supplying rapidly.

After receiving the order, the RSU team will promptly and carefully process the order – from its receipt to the shipping of the fittings. For the production of such fittings, we have dedicated resources in a state-of-the-art manufacturing cell with CNC machinery and tools.



*24 Hours Turn-Around Capability
with access to 19 modern CNC*

We offer more

Where corrosion resistance is vital,
we have the best solution in stainless steel



For more information about Parker's Stainless Steel Products please refer to our catalogue 4400.1 "Hydraulic Hose Fittings in Stainless Steel"



Mining hose, fittings and equipment



Parker's mining hoses, fittings and adaptors provide a complete, reliable hydraulic package to connect and support the mining equipment. All Parker mining hose products combine international approvals with total system integrity and long service life in hostile conditions.

Special coatings and carefully selected materials ensure reliability in corrosive environments.

For more information about Parker's Mining Products please refer to our catalogue 4410 "Mining Hose, Fittings and Equipment"



We offer more than just innovative products and solutions

We're constantly updating our customer service options to help you work smarter, faster, and better.



Parker offers concrete knowledge of respective products where selection criteria, scope of application and breadth of operation are invaluable. It is the goal of Parker to offer the possibility to our customers to always acquire and regularly refresh this expertise for daily implementation. In this respect, Parker's Hose Products Division Europe extensive training program offers valuable support.

The program incorporates product and target group training for acquiring not only basic knowledge, but also extensive familiarisation through practical experience with the products, incorporating identification and demonstration of application-specific operational advantages. To ensure that all participants enter the classroom with a fundamental product knowledge, Hose Products Division Europe has developed a complete training concept, including a training sample case.

News for business

This training is ideal for an audience who is interested on all kind of hose products/business news and their benefits for the customers.

- In addition to the regular training offerings, Parker Hose Products Division is offering customised in-house training sessions.
- To support all training activities, a sample case with the part number **HPDE-SAMPLE-CASE** has been developed with a comprehensive product selection to
 - provide you the tools allowing you to run and lead training sessions
 - improve your knowledge of the Division and its products
 - improve your knowledge of the hose market

Hose assembly workshop training

In this training the participant will get familiar with all major aspects (facility + equipment/operational steps/safety requirements) to produce a proper hydraulic hose assembly. This training supports all activities around a certified hose workshop.

Qualified person – hydraulic hose technology

The participants will learn about international safety standards and requirements for hydraulic hose products. The training course includes guidance to select the right product depend on application conditions and Parker instructions to produce a proper hose assembly. The training will convey also knowledge about potential failure and aging affects and how to avoid them.



Part Number HPDE-SAMPLE-CASE

Basic product training

The scope of this training is for beginners in hydraulic hose business and helps to acquire basic knowledge about hose products incl. workshop equipment. The participant is able to identify all hydraulic hose products and to answer application related questions based on catalogue knowledge, the product range and production selection criteria.



Value Added Services

ParkerStore™

At Parker Hannifin, we're continually looking for ways to deliver more products, more efficiently.



The Global ParkerStore™ network enables Parker to provide

- Prompt, efficient, professional in-store services while you wait
- A safe, friendly and convenient shopping environment
- A greater range of parts options so you get exactly what you're looking for

Customers trust ParkerStores to provide OEM and MRO customers with direct access to

- Custom-made hydraulic hose assemblies and complementary products to support their applications and decrease their downtime
- Expert technical support
- Professional, personalized services, including 24/7/365 support
- The convenience, comfort and amenities of a local service provider.

ParkerStore™ Container Service



The ParkerStore container is a transportable workshop, providing on-site maintenance and product support for large construction projects such as roadworks, tunnels, railways, underground systems, etc. Provides an on-site product and hose replacement service. With this service on your site, you can reduce your downtime keeping your project on time and on budget!



Cargo Doors



Storage Racks and Cabinets



Full Electrical Service



Security Doors



Heating/Cooling



Rugged Lighting Service

HOSE DOCTOR®

Parker HOSE DOCTORS® are a network of independently-owned, mobile service technicians built around the commitment to identify and replace hose assemblies wherever their customers need them, with the fastest response times possible.

HOSE DOCTORS® are an extension of the worldwide Parker distribution network, coupling their service commitment with Parker products – the highest quality hoses and fittings available in the market today.



Value Added Services

Kitting

Multiple components are supplied under a single part number

- Reduced number of suppliers
- Reduced stocks and no obsolete items
- Optimized management (stock and supplies)
- Simplified and optimised order handling
- Reduced assembly costs
- Greater productivity



Tech Services

Optimises the performance of your hydraulic and pneumatic circuits

- With Parker Tech Services involved, your time to market is shorter, which saves on development costs
- The 3 year no-leak guarantee enhances your reputation and lowers your warranty costs
- More reliable operation lowers your customer's operating costs
- More efficient performance and no-leak guarantee is beneficial to the environment
- Parker worldwide coverage ensures you can use the service and save costs wherever you are



Breadman Vendor Managed Inventory

Lean logistics and delivery of Parker products and kits directly to the customer's assembly line, work stations or warehouse

- 100 % parts availability minimises downtime, increases production and reduces costs
- Elimination of stock checking reduces manpower and maintains production levels
- Daily delivery reduces inventory and overheads
- Electronic order processing eliminates paperwork and reduces administration costs
- Enjoy a customized program where Parker personnel can manage your inventory in person or remotely
- Reduce overall inventory, increase your inventory turns and increase your efficiency



Whatever application you have

we have the right solution

Hose Products Division Europe supplies premier customer service by focussing on customer needs and analysing the entire business environment in which our customers operate.

Our expertise spans the core motion and control technologies, and we apply it to make a meaningful difference in the lives of people everywhere. Parker can be found on and around everything that moves!

We engineer and manufacture high quality hoses and hose fittings to help our customers to achieve a higher level of profitability by considering

- our customers' needs and desires
- what hose and fitting technology our customers prefer
- how to advance customer's brand loyalty

By working with us, you have access to an integrated network of global manufacturing plants as well as sales and service offices in 50 countries.



Transportation



Military



Agriculture



Forestry



Utility Equipment



Machine Tool



Waste & Refuse



Marine



Ground Support
Equipment



Mining



RV & Bus



Construction



Grounds & Building
Maintenance



Railroad

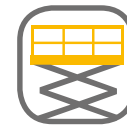

Personnel Lift
Equipment



Oil Field Service



Material Handling



Paving & Road
Maintenance



Industrial



Inplant
Automotive



Hydraulic Hoses, Fittings and Equipment

Technical Handbook



ENGINEERING YOUR SUCCESS.

Crimp systems you can trust

Along with the ever-growing power and efficiency of each type of machinery and increasing working pressures and flow rates of their hydraulic systems, multispiral hose is gaining an increasingly important role in machine design. Parker Hannifin, as the world leader in the hydraulic hose market, responds to these highly demanding requirements with 3 comprehensive systems – Parkrimp No-Skive, Interlock No-Skive and Parlock Skive type.

Parkrimp *No-Skive* system

is based on no-skiving technology (without removing the rubber cover before assembling)

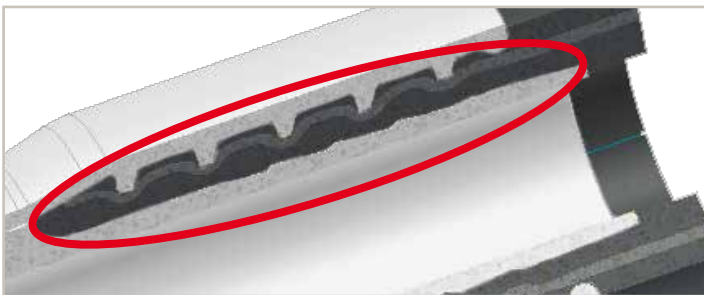

Interlock *No-Skive*™ system

for Compact Spiral™ hoses



ParLock system

uses external or internal and external skiving (Interlock) technology

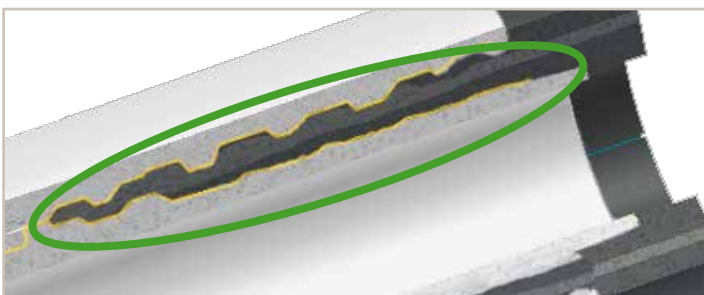

Each of the systems consists of integrated ranges of hose, fittings and assembling equipment and know-how, all of which are:

- Designed and developed together
- Tested and approved together
- Produced and supplied together

This way Parker Hannifin can guarantee:

- The highest quality and safety and the longest service life of the final product – to the end users,

and at the same time:

- The easiest, most efficient and safe production process – to the assemblers.

In this way Parker Hannifin also meets the requirements of SAE J1273 and ISO 17165-2, which pay particular attention to matching the hose with the fittings and to their compatibility proven by the manufacturer.

Parkrimp *No-Skive*

The easy to operate crimp system from textile to 6 spiral high tensile steel wire

Parkrimp No-Skive is synonymous with the best solution for assembling hydraulic and related hose and fittings from both the technical and the manufacturing points of view!

Throughout the progressive rubber and metal compression during the crimping process the reinforcement always remains intact. The meticulous design,

testing and manufacturing processes of Parkrimp No-Skive hose and fittings, combined with the approved crimping diameters provide an excellent mechanical connection between the hose and the fitting. This absolutely leak-free connection gives long service life even with the highest pressures associated with 4- and 6-spiral hose assemblies.

The smartly designed and time-tested Parkrimp No-Skive assembling equipment combined with Parker's assembling know how allow the safest, most efficient and mistake-proof assembly process. The Parkrimp equipment allows cost and time savings to the assembler and guarantees a defect-free, reliable and durable final product to the end-user.

Parkrimp *No-Skive* hose and fittings

the system for fast and leak-free assemblies

- For crimping Parkrimp No-Skive fittings only
- No skiving tool needed
- No need to remove the cover
- Quick and easy: no gauges to set on the machine
- Portable machines for field repair
- Meets EN safety regulations

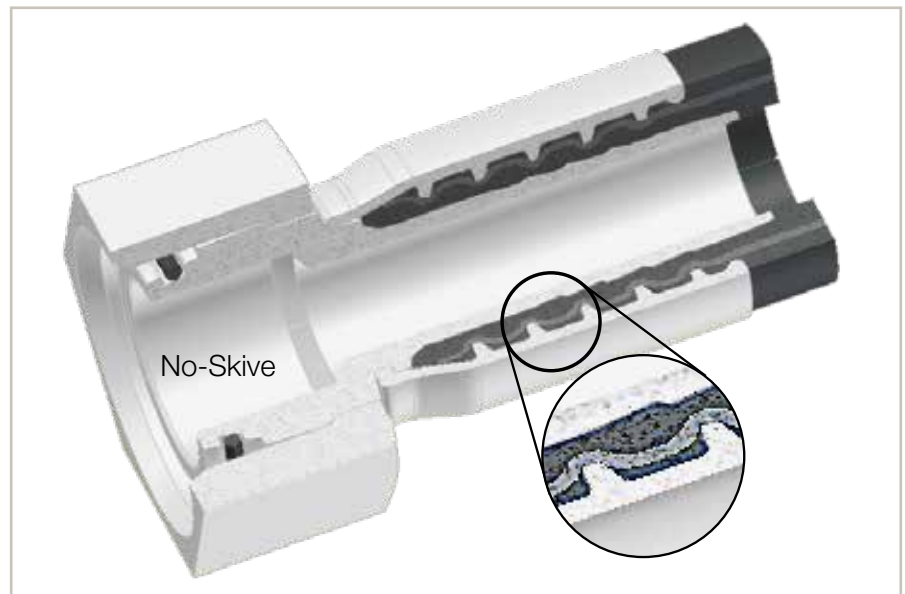

Parkrimp *No-Skive* hose and fittings the system with the perfect match



The perfect match

The complete system from one source. No-Skive hose, No-Skive fitting and crimping machine with world-wide guarantee and availability.



Parker's colour-coded die sets

No loose parts to mismatch or misplace – die set segments linked together. Die sets provide 360° evenly applied crimping forces for an ideal crimp result.



Parkalign®

Parker's exclusive Parkalign® positions the fitting in the dies perfectly every time.

Interlock *No-Skive*™

The system for Compact Spiral™ hoses

For applications with extremely dynamic pressure profiles, pressure surges and peaks, as well as applications with intense vibrations and hose flexing (bending), especially when close to the fitting, a strong mechanical grip by the fitting onto the hose is paramount. A popular method accepted by the market of achieving this mechanical grip in such applications is to use hose fittings that „lock“ the metal reinforcement of the hose directly between the metal shell and nipple (a concept generally called „Interlock“).

As a response to the market requirement for an „Interlock“ hose fitting system, Parker has developed the Parlock and Interlock No-Skive program. This range consists of a specific range of hose, fittings and assembly equipment combined with Parker crimping know-how.

1piece No-Skive 77 series fitting covers the full range of sizes for both Compact Spiral™ hoses 787TC and 797TC hoses – designed to engage the inside of the tube into the spiral wire reinforcement

Parker's exclusive Interlock No-Skive design, with both internal and external „Bite the Wire“ technology for assured connection strength and for better hose to fitting connection which reduces leaks and increases holding power.

- Superior holding power
- Reduced „push- in“ force
- Smart sealing geometry to improve the cool down leakage performance
- Approved by the German DGUV (German Accident Prevention & Insurance Association) for applications requiring Interlock connection e. g. injection moulding machines (design standards EN 201).

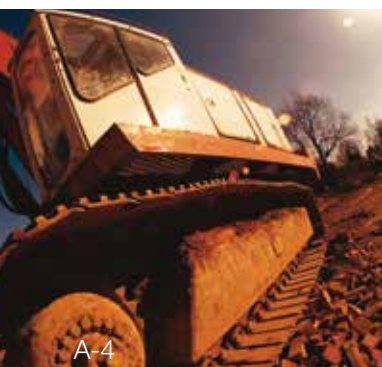
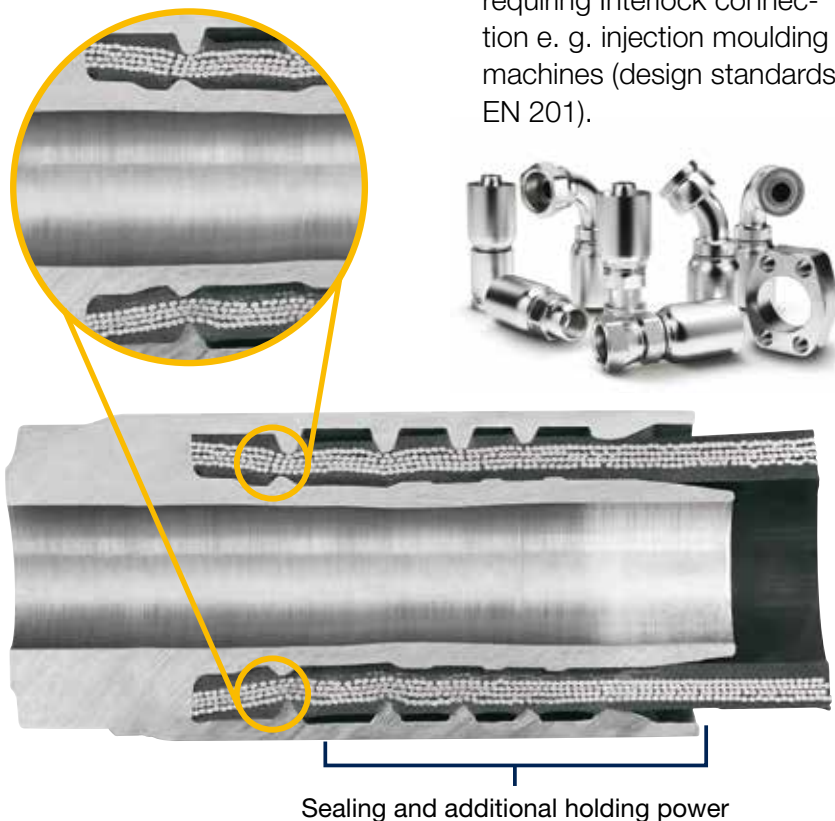

ParLock

The system for extremely dynamic pressure applications

Applications requiring the ParLock system

- Hydrostatic transmissions (combine harvesters, large tractors, excavators, etc.)
- Large injection moulding machines
- Large material handling machines (container handling)
- Vibratory hammers
- Tunnelling machines
- Excavator booms
- Forestry machines
- Blow-out preventers in oil and gas

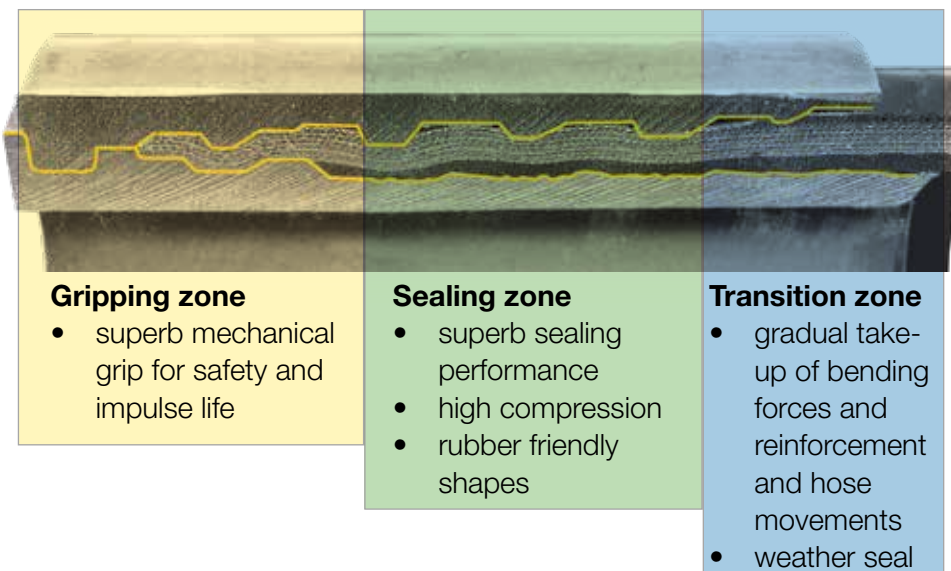

For manufacturing the ParLock hose assemblies Parker Hannifin offers

- Skiving machines for external and internal skiving
- Universal crimping machines with adjustable crimping diameter
- Detailed assembling instructions (see further in this catalogue)



Hydraulic hoses and fittings

Hoses and fittings terminology – the basics	Aa-2 – Aa-8
Safe hose assemblies working steps	
1 STAMP	Aa-9 – Aa-11
2 ASSEMBLY – 1piece Parkrimp No-Skive fittings	Aa-12 – Aa-14
– 2piece ParLock fittings	Aa-15 – Aa-16
3 INSTALLATION	Aa-17 – Aa-19
How to order (Part number description)	Aa-20 – Aa-21
Identifying fitting types hoses and fittings	Aa-22 – Aa-29
Storage	Aa-30 – Aa-31
Safety first!	Aa-32 – Aa-33
Parker safety guide	Aa-34 – Aa-38
Technical data	
Hose overview	Ab-2 – Ab-4
Hose fittings overview	Ab-5 – Ab-8
Hose fittings pressure ratings	Ab-9 – Ab-11
Hose fittings nomenclature	Ab-12 – Ab-15
Classification bodies	Ab-16
Approvals for Parker hydraulic hoses	Ab-17 – Ab-19
Conversion chart	Ab-20
Temperature and pressure chart	Ab-21
Flow capacity nomogram	Ab-22
The correct method to fit female swivel ends	Ab-23
The correct method to fit ISO 6162-1 and ISO 6162-2 flanges	Ab-24 – Ab-25
Chemical resistance table	Ab-26 – Ab-34

Hoses and fittings terminology

The basics!



Hydraulic hose is a full-value part of the hydraulic system transmitting the hydraulic power – not just conveying a fluid – and deserves adequate attention, just like the other hydraulic components which generate, consume or control that power. Furthermore, it is just hydraulic hose assemblies that are usually most exposed to various extreme conditions in which they have to retain full functionality and assure serviceability of the hydraulic system and safety of the operators.

In spite of that, the importance of the hydraulic hose is often overlooked and underestimated.

This catalogue is to provide guidelines to correct hoses and fittings selection and hose assembly manufacturing and to highlight the most important safety aspects for its service in the field.

Hydraulic rubber hoses

Tube – inner layer of rubber compound with chemical and physical properties to be long-term resistant to the fluid and working conditions.

Reinforcement – 1 or 2 (exceptionally 3) layers of braided textile fibre or highly tensile steel wire or 4 or 6 layers of spiralled very highly tensile steel wire to bear high pressure but allow flexibility of the hose.

Cover – outer layer of rubber compound with chemical and physical properties to protect the reinforcement against ambient conditions and mechanical damage.

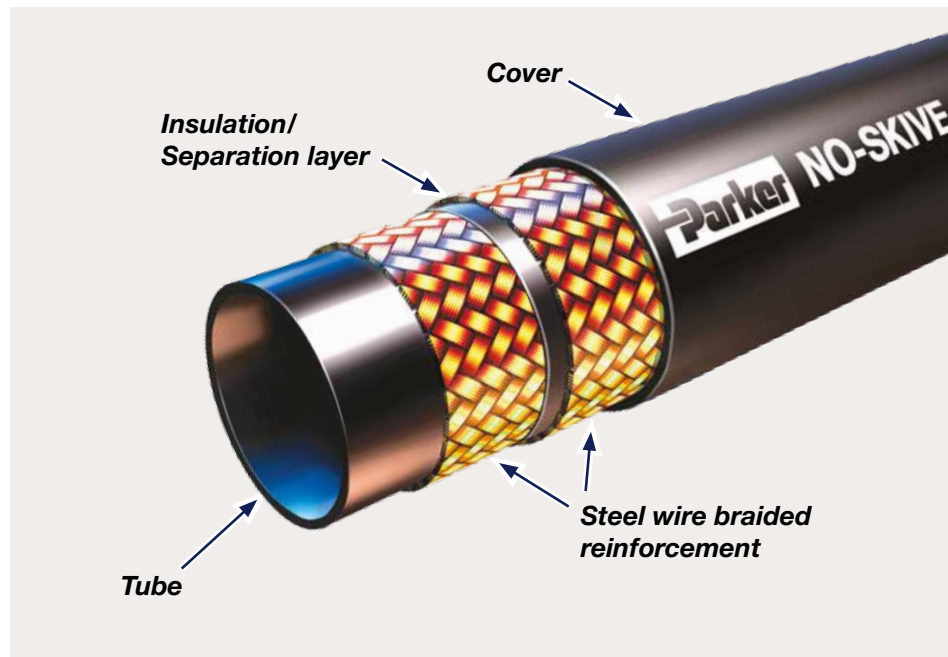

Depending on the pressure level we classify the hydraulic hoses in this catalogue into 4 groups:

- **Push-Lok**
 - low-pressure hoses with self-grip connection to fittings
- **Low pressure and Transportation**
 - 1 and 2 textile yarn braided and 1 steel wire braided hoses
- **Medium pressure**
 - 1 and 2 steel wire braided hoses and suction hoses
- **High pressure**
 - 3 steel wire braided hoses and 4 or 6 steel wire spiral hoses

Depending on the method of hose and fittings assembling we offer 2 basic product concepts (integrated product lines of hoses, fittings, assembling equipment and know-how):

- **Parkrimp**
 - complete range of braided and spiralled hose, not needing removing (skiving) of the hose cover before assembling.
 - Compact Spiral hose with patented internal and external “Bite the Wire” technology.
- **ParLock**
 - specific range of 4 and 6 spiral hose for extreme applications which require skiving of the cover and for bigger sizes also of the inner tube.

Hose fittings

Nipple (insert etc.) – the body of the fitting whereof one end is coupled to the counterpart of a hydraulic component (termination end), while the other end is inserted into the hose (tail end).

To assure compatibility with the counterpart, the designs of termination ends are specified by international standards.

The main role of the tail end is to provide durable sealing between fitting and hose.

Shell (socket, ferrule etc.) – the outer part of the fitting provides mechanical connection of the fitting with the hose. To assure a strong hold of the hose reinforcement, shells are generally crimped on to the hose during assembly.

The designs of tails and shells are not standardized but they are in the sole responsibility of the manufacturer.

Due to this reason fittings of various manufacturers are not automatically compatible with hoses of other manufacturers - unless the combination is fully tested acc. to the relevant international hose standards! This is also imposed by all international standards for hydraulic hose usage practices and fluid power systems safety!

In this catalogue we offer 3 kinds of fittings:

- **Push-Lok**

- special nipples connectable to Push-Lok hose without any shells.

- **1piece fittings**

- pre-crimped shells on nipples make the assembling of hose with fittings easier, more effective and reliable.

- **2piece fittings** (for **ParLock hoses**)

- for extreme applications requiring full metal-to-metal connection of the hose reinforcement with the shell or even with the nipple (external or external plus internal skiving).

- **2piece fittings** (for **Parkrimp hoses size -40 and -48**)

- for big bore applications
Please use adjustable crimpers only
(47 series nipple and 10048 shell)



Note

Parker Hannifin also offers a limited range of 2piece Parkrimp No-Skive fittings but being special products they are not included in this catalogue. For more information about 2piece fittings, please contact our Division Helpdesk (HPDE_Helpdesk@parker.com)

Note

Parker hoses have to be assembled with Parker fittings only! Crimping Parker hoses with fittings of other manufacturers may have serious impact on the hose assembly functionality and safety!

Except Push-Lok, all fittings in this catalogue are crimped and include:

- All Parker 1piece fittings
 - suitable for the **Parkrimp** product line
 - suitable for the **Interlock** product line
- All 2piece fittings in this catalogue
 - suitable for the **ParLock** product line and **Parkrimp** product line (size -40 and -48 only)



Hose assembly

It is the interplay between the fitting tail and shell designs and the hose design with its material properties that primarily determine performance, service, durability and safety of the final hose assembly. Yet compatibility of hose and fitting cannot be just theoretically projected. It requires exhaustive and repetitive laboratory and field tests and further tuning of the designs.

Non-compatibility of hose with fittings or combination of hose and fittings from different manufacturers, do not only influence performance of the hose assembly, they often lead to hose failure with serious health or life-threatening consequences! For this reason the main international standards for hydraulic hose usage practices and fluid power systems safety strictly warn not to mix hose with fittings from different manufacturers!

Parker Hannifin has not approved products of any other manufacturer for combination with Parker hoses and/ or Parker fittings and guarantees full compatibility, reliability and safety only for combinations of genuine Parker parts selected and assembled in accordance with the guidelines included in this catalogue!

Hose Hint

Never mix & match one manufacturer's fittings with hoses from another manufacturer!

Parker hoses, fittings, assembling equipment and know-how are designed as an integrated system, guaranteeing the utmost product performance, reliability and safety!



Pressure rating

Hydraulic hose is a component transmitting hydraulic power and the pressure is obviously the main physical quantity determining the hydraulic power. For hydraulic hoses the following pressure ratings are used:

Working Pressure – the pressure for which the hose assembly is designed to operate over its whole service life - provided the other parameters (temperature in particular) stay within reasonable limits.

For apparently static applications (e.g. with hand pumps or water jetting) consult the Working Pressure with your Parker Field Representative or with our Technical Support (HPDE_Helpdesk@parker.com).



Burst Pressure – the pressure which statically applied causes destruction of the hose. Technical standards for hydraulic hoses define the burst pressure to be equal to or higher than 4 times the working pressure (design factor 4). This rule and the burst pressure in general serve to hose manufacturers for design and testing of the hose only! If you happen to know the burst pressure of certain hose, never use this rule backwards to deduce its working pressure!

$$4 \times \text{Working Pressure} = \text{Burst Pressure}$$



Pressure rating

Remember the working pressure

1. The **hose assembly working pressure** is given by the weakest "link in the chain" - i.e. by the lowest of the working pressures of the hose and of both fittings. Do not forget to check the working pressure of the fittings when selecting components for a hose assembly (see pages **Ab-9** to **Ab-11** of this catalogue!)
2. The **real hydraulic system operating pressure** is not given by the system components setup but by the application which introduces into the system peaks and surges or by the functioning of the system itself (rapid closing or opening) which induces spikes and pulses. Such occurrences are detectable only by sensitive electronic pressure gauges and are usually not fully or not at all filtered out by safety or relief valves and exert excessive strain on the hydraulic system – hoses and tubes first of all!
3. **The hose assembly working pressure must always be equal to or higher than the real hydraulic system operating pressure incl. all peaks, surges, spikes and pulses!**



Unit of measure

The most commonly used unit of measure for hydraulic pressure worldwide is MPa (Mega Pascal) – used also in this catalogue. In the US and in Anglo-Saxon markets also psi (pounds per square inch) is officially used and many European producers, users and even technical standards still also use bar.

For the conversion chart of various units of measure see page **Ab-20**.

Hose Hint

Working pressure is a dynamic parameter, burst pressure is a static parameter. High burst pressure does not mean high working pressure!

In order to assure mutual compatibility, producers of hydraulic equipment, producers of machines and also international technical standards profess certain preferred pressure levels:

MPa	21	28	35	42
bar	210	280	350	420
psi	3000	4000	5000	6000



Hose Hint

For highly demanding applications (dynamic pressure, high number of pressure cycles, high temperature etc.):

- Select hose with much higher working pressure than officially requested
- Select multispiral hose instead of braided or ParLock instead of Parkrimp No-Skive
- Select all of that in order to increase service life and safety!

Hose size

The other parameter determining the hydraulic power in direct proportion is the flow rate – i.e. the fluid velocity. However, too high fluid velocity gives rise to turbulence, pressure drops and heating up of the fluid, causing excessive ageing of hoses and other components or even their damage. To keep the fluid velocity below certain limits but achieve the required flow rate, the size of the hose has to be defined appropriately (see Flow Capacity Chart on page **Ab-22**).

As the first technical standards for hose came from the USA, dimensions of hose are defined in inches and hose sizes are expressed in inches or from inch-derived units. Global companies – such as Parker – use **dash sizes** (-1 = 1/16”), while the European standards use DIN-based DN (diameter nominal) sizes.

Note

SAE 100 R5 hydraulic hose, SAE J1402 air-brake hose and SAE J2064 air-conditioning hose use sizes equivalent to corresponding metal tube I.D. – different from the other hydraulic hoses (see datasheets of these hoses in this catalogue).



dash	inch	DN	mm
-3	3/16	5	4.8
-4	1/4	6	6.4
-5	5/16	8	7.9
-6	3/8	10	9.5
-8	1/2	12	12.7
-10	5/8	16	15.9
-12	3/4	19	19.1
-16	1	25	25.4
-20	1 1/4	31	31.8
-24	1 1/2	38	38.1
-32	2	51	50.8
-40	2 1/2	63	63.5
-48	3	76	76.2

Size	Inch	mm	DN
-6	6/16	6/16 * 25,4 = 9,525	10
↓	↓	↓	↓
-6	3/8	9,5	10

Ambient and fluid temperature



Temperature is one of the factors which most negatively affect rubber characteristics and so it deserves particular attention of the hydraulic system designers and hose users!

High temperature causes degradation of rubber and accelerated ageing of the hose – an effect which can be yet further intensified by the chemical impact of the fluid. That is why the upper temperature limits specified in this catalogue refer to the fluid temperature and why they differ for various media.

However, permanent or long-term use at temperatures close to the upper limit would considerably shorten the hose service life in

any case and if it cannot be avoided the hose should be replaced more frequently once it shows first symptoms of deterioration (stiffness, hard cover and cracks).

Low temperature, on the other hand, affects mainly physical properties of rubber – making it more fragile – and so at extremely low temperatures hose being bent may crack in tube or cover which can cause immediate or later leakage, burst or reinforcement damage. As there are not many hydraulic fluids which flow at or below -40 °C, the lower temperature limits specified in this catalogue refer rather to ambient temperature below which the hose should not be bent or otherwise hit from outside (while staying passively in it does not cause serious problems).

Hose Hint

The combination of high temperature and high pressure reduces the hose service life. Pay attention to regular inspection of such hoses and their preventive replacement if the cover is brittle or cracked!

Hose bend radius



The role of hydraulic hose is to provide a connection of relatively movable parts of the circuit and so its bending is a natural state the hose is designed for. However, the layout of the reinforcement wire or fibre inside a bent hose **may** shift to less appropriate positions. The tube and cover are stretched and become thinner and so the pressure resistance of a bent hose considerably decreases. For this reason working pressure and bend radius are negatively interdependent parameters and the max. working pressures specified in this catalogue are conditioned by respecting the min. bend radii.

Hose Hint

Bend radius and bending force are two different things! Not even apparently "flexible" hose (with low bending force) may be bent below the min. allowed radius!

Recommended fluids

As the power transmitting – not fluid conveying – element, hydraulic hose should be first of all used for the primary applications and with the recommended fluids specified in this catalogue!

For low pressure applications with various non-hydraulic fluids see our catalogue **"4401 Industrial Hoses"**.

If for required higher pressure or for any other reason you cannot use industrial hoses, follow the instructions in this catalogue (pages **Aa-10** – Application, **Aa-11** – Media and **Ab-26** to **Ab-34** – Chemical Resistance Table).

Safe hose assembly

Working steps

1 Before you spec it, STAMP it.

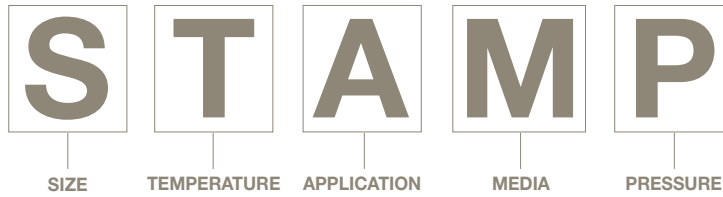

SIZE

Parker uses a system of measurement called Dash Numbers to indicate hose and fitting size. The dash number, or dash size, is the measure of a hose's Inner Diameter (I.D.) in sixteenths of an inch.

This measuring system of the inside diameter of the hose is universally used by the fluid power industry today. Don't know the hose size? Check the layline. If the original printing has worn off, the original hose must be cut and the inside diameter measured. Be sure to measure the overall assembly length and fitting orientation before cutting the hose.

The hose I.D. must be sized accurately to obtain the proper flow velocity. A flow that's too slow results in sluggish system performance, while a flow that's too high causes excessive pressure drops, system damage, and leaks.

Use the Flow Capacity Nomogram page **Ab-22** to determine the proper hose I.D. for an application's flow rate requirements.

TEMPERATURE

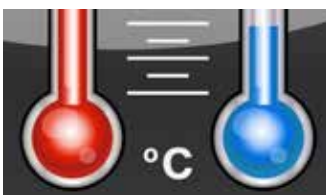

High Temperature

For high temperature hoses choose the part numbers ending in "6" – e.g. **436**

Low Temperature

For low temperature hoses choose the part numbers ending in "LT" – e.g. **461LT**

When specifying hose, there are two temperatures you need to identify. One is the **ambient temperature**, which is the temperature that exists outside the hose where it is being used; the other is the **media temperature**, which is the temperature of the media conveyed through the hose.

Very high or low ambient temperatures can have adverse effects on the hose cover and reinforcement materials, resulting in

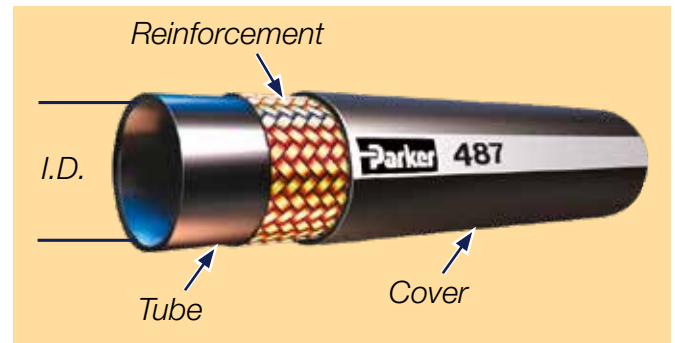

The hose size is determined by the inside diameter which can be measured or found on the layline.

Max. recommended fluid velocity:

- Pressure lines – ca. 6.1 m/sec
- Return lines – ca. 3 m/sec
- Suction lines – ca. 1.2 m/sec

Hose Hint

Don't try to save your own or your customer's money by downsizing the hose! It would cost your customer more to replace damaged hoses, other components and oil, and it will cost you more as you may lose your customer!

reduced service life.

Media temperatures can have a much greater impact on hose life. For example, rubber loses flexibility if operated at high temperatures for extended periods.

Parker hoses carry different temperature ratings for different fluids. For example, 611HT hose has a temperature range of -40 °C to +150 °C for petroleum-based hydraulic fluids. However for water, water/glycol, and water/oil emulsion hydraulic fluids, the range drops to a rating of up to + 85 °C. Air is rated even lower at up to + 100 °C.

Some media can increase or decrease the effects of temperature on the hose. The maximum rated temperature of a hose is specific to the media.

Working steps

APPLICATION

Before selecting a hose, it is important to consider how the hose assembly will be used.

Answering the following questions may help:

- **What type of equipment is involved?**
- **What are the environmental factors?**
- **Are mechanical loads applied to the assembly?**
- **Will the routing be confined?**
- **What about hose fittings – No-Skive or ParLock?**
- **Will the assembly be subjected to abrasion?**

Hose Hint

You do not always need additional sleeve to protect the hose against abrasion!

*Parker high and extremely high abrasion resistant **TOUGH COVER** and **SUPER TOUGH** versions with 80-times and 450-times higher abrasion resistance do the same, but better and cheaper!*

Sometimes specific applications require specific hoses. For example, applications where hoses will encounter rubbing or abrasive surfaces, would be best handled

by our family of abrasion-resistant hose with both Tough and Super Tough covers. When application space is tight, bend radius is another important consideration. Parker offers a full line of hoses designed for one-half SAE bend radius at full SAE-rated pressures. We offer hoses with increased flexibility and smaller outer diameters enabling faster, easier routing in small spaces, reducing both hose length and inventory requirements. Industry standards set specific requirements concerning construction type, size, tolerances, burst pressure, and impulse cycles of hoses. Parker hydraulic hoses meet or exceed standards such as:

- **ISO (International Organization for Standardization)**
- **EN (European Norm)**
- **SAE (Society of Automotive Engineers)**
- **DIN (Deutsches Institut für Normung)**

Governmental agencies control additional standards for particular industries such as U.S.C.G. and ABS. You must select a hose that meets the legal requirements as well as the functional requirements of the application.

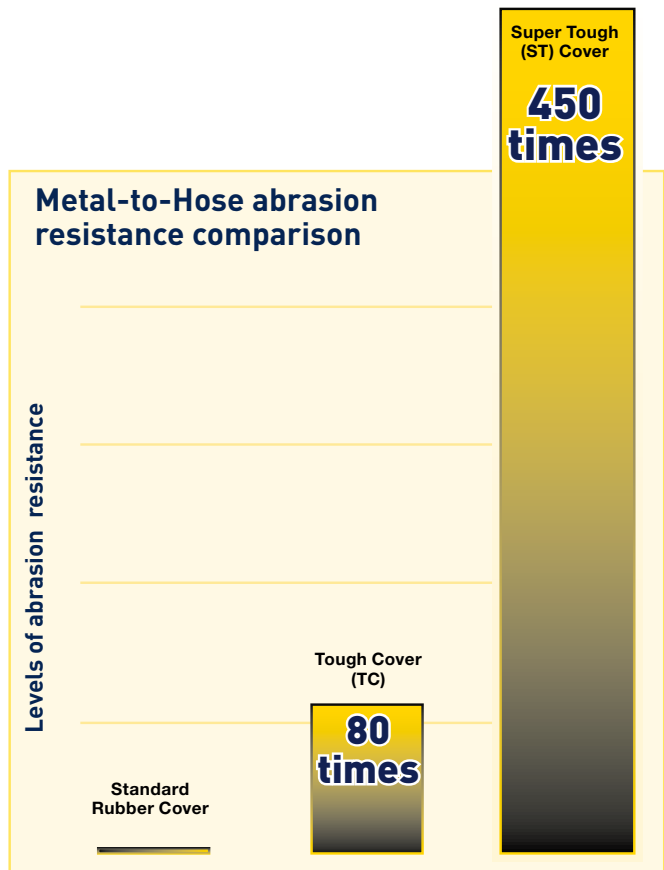

Working steps



MEDIA

What will the hose convey?

Some applications require the use of specialized oils or chemicals. The hose you order must be compatible with the medium being conveyed.

Compatibility must cover the inner tube, the cover, hose fittings, and o-rings as well. Use a Chemical Resistance Chart to select the correct components of the hose assembly that will be compatible with your system's media. The chart contains the chemical resistance rating of a variety of fluids.

See pages **Ab-26** to **Ab-34**.



PRESSURE

When considering hose pressure, it's important to know both the system working pressure and any surge pressures and spikes. Hose selection must be made so that the published maximum working pressure of the hose is equal to or greater than the maximum system pressure.

Surge pressures or peak transient pressures in the system must be below the published maximum working pressure for the hose.

Each Parker hose has a pressure rating which can be found on the hose table. All Parker hydraulic hoses have passed the industry rated specifications for burst pressure and carry a 4:1 design factor unless otherwise noted. Burst pressure ratings for hose are for manufacturing test purposes only. They are not an indication that the product can be used above the published maximum working pressure. Care must also be taken when looking at the "weakest link" of the hose assembly. A hose assembly is rated at the maximum working pressure of the hose and the fitting component. Therefore the maximum working pressure of the hose assembly is the lesser of the rated working pressure of the hose and the end connections used.

Always check the fitting working pressure – see pages **Ab-9** to **Ab-11**.



Hose Hint

*Although fittings are made of steel, their working pressure is often lower than that of hose!
Don't forget to check the working pressures of both fittings when selecting components for your hose assembly!*

Working steps

2.1 ASSEMBLY 1piece Parkrimp fittings

Cutting

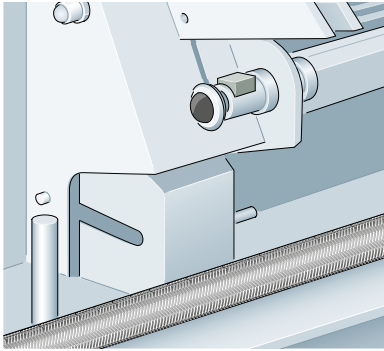

Hose is cut to the desired length according to specifications. The correct hose cutting tool ensures a square, clean cut without damaging the pressure reinforcement. Depending on the hose type, different kinds of cutting blades must be used:

- 1) Smooth cutting blade:
for high tensile textile layer, return line hoses and steel wire braided hoses
- 2) Serrated cutting blade:
for hoses with 4 or 6 spiral layer of high tensile steel wire

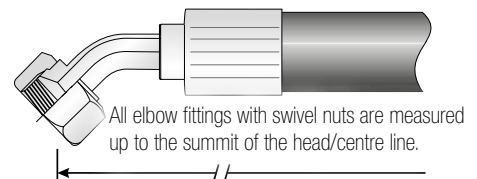
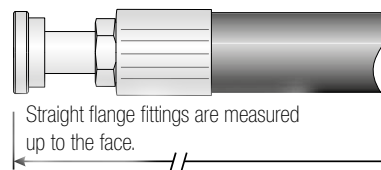
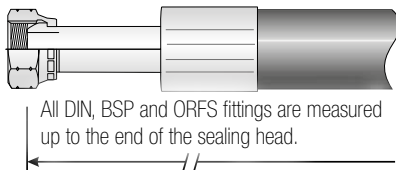
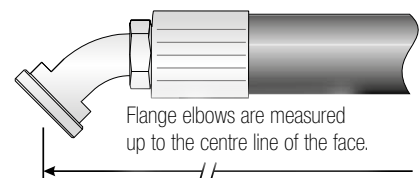
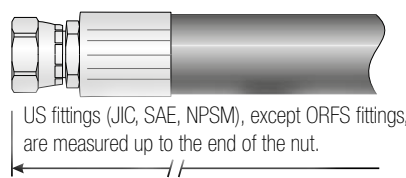
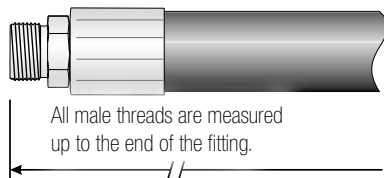

Tolerances for hose assemblies

Length tolerance according to DIN 20066 Tabelle 6

Hose assembly length (mm)	Diameter (mm)	
	≤ 25	> 25
up to 630	+7 -3	+12 -4
over 630 up to 1250	+12 -4	+20 -6
over 1250 up to 2500	+20 -6	+25 -6
over 2500 up to 8000	+1,5 % -0,5 %	
over 8000	+3 % -1 %	



According to EN ISO 4413, hose assemblies are not permitted to be manufactured from any components that have already been in use in other hose assemblies.

Cleaning after cutting

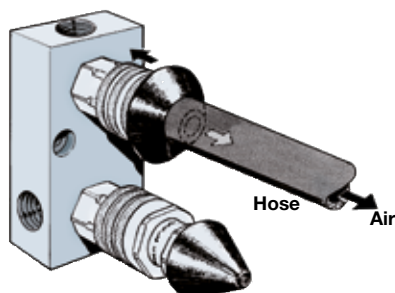

After cutting it is recommended to clean the hose with compressed air from both sides. Please make use of Parker's Cleaning System TH6-7 – A quick and simple system – Delivered with two plastic nozzles for hoses from size -4 up to -32. The hose is pressed against the nozzle and thereby opens a valve to allow the compressed air to blow through the hose and blow out loose particles.

Working steps

Marking

According to EN and ISO standards, hose assemblies must be clearly and permanently marked. They must bear the following information:

- Manufacturer's identification
- Date of production (year and month)
- Maximum permissible working pressure of the whole hose assembly

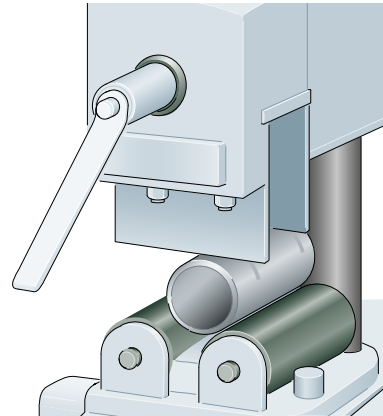

Crimping 1 piece Parkrimp No-Skive fittings

Crimping is the safest, fastest and most commonly used method of making a hose assembly. The Parker crimping systems ensure precise, leak-free and tear-proof assembly of hose and fitting. Reaching the exact crimping diameter is possible with Parkrimp crimping tools or adjustable crimping tools. When crimping, it is essential that hose, fitting and crimping tool (dies) match precisely. For crimping dimensions please refer www.parker.com/crimpsource-euro.

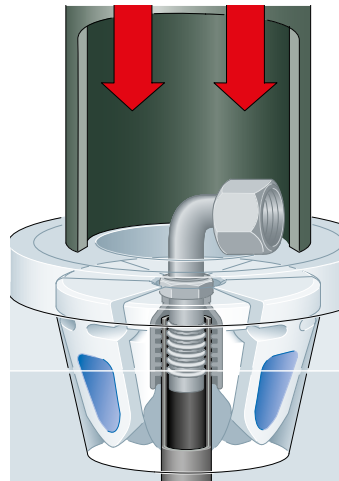

Furthermore, the insertion depth, a square cut hose, correct, burr-free and clean crimping are important to ensure a correctly formed and leak-free connection of hose and fitting. Using the Parkrimp hose crimpers or adjustable crimpers, the fitting is crimped onto the hose in one slow and smooth crimping procedure. A depth stop with automatic function ensures safe positioning of the fitting. This guarantees the correct crimping of hydraulic hose assemblies.



Find the correct crimp specification on the push of a button!

www.parker.com/crimpsource-euro

26, 43, 46, 48, 70, 73, 77 series:

Push the hose all the way into the coupling. Place the hose next to the fitting shell and mark the insertion depth or the length of the fitting onto the hose, push the hose into the fitting until the mark on the hose is even with the end of the shell. If necessary simply wet the fitting end with a drop of hose oil. Do not lubricate if using spiral hose.

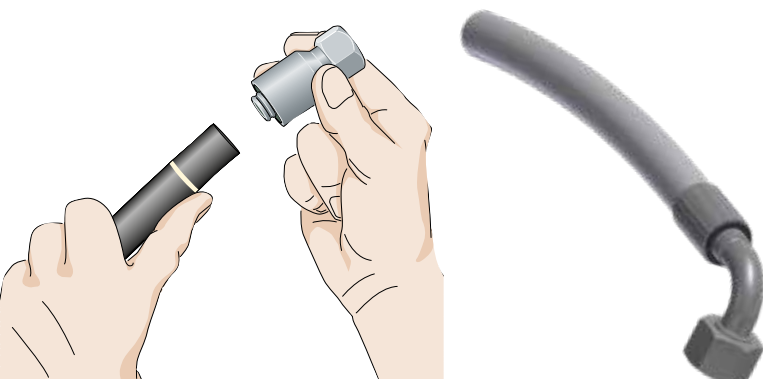

Angle setting

The displacement angle of a hose assembly is indicated only when two elbow fittings are assembled in a displaced way.

The angle always has to be indicated clockwise looking from the elbow fitting at the back to the one in the front. Please also consider the natural bending of the hose.

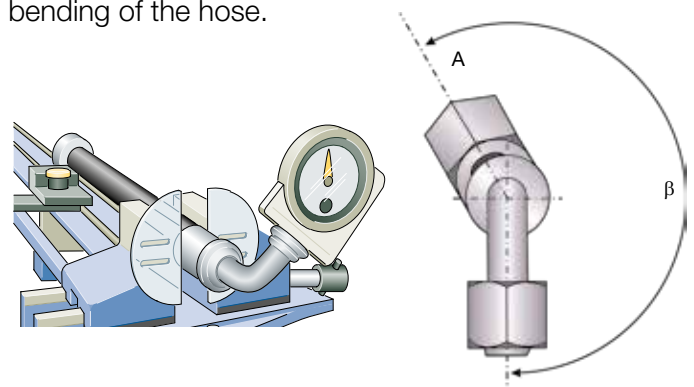

Working steps

Testing (optional)

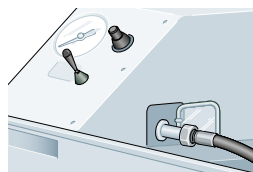

Static test pressure depending on the hose type and application is applied to the finished hose assembly for a pre-defined period of time. The test procedure can be documented using a test logging unit. The test pressure for Parker hydraulic hose assemblies is 2 times the value of the dynamic operating overpressure.

Proof pressure test

This test is typically carried out on customer request according to a method defined by the ISO 1402 standard. The test should be done at normal ambient temperature with a proof test bench using water or another suitable liquid. The hose assembly should be pressurised for between 30 to 60 seconds at twice the working pressure of the hose assembly. There should be no leakage or pressure drop. A complete test report should be provided together with the hose assembly to the customer.

Cleaning

Hydraulic systems have to reach a defined degree of cleanliness. To ensure that and to achieve certain cleanliness classes you can use different cleaning devices for a fast and efficient cleaning of hose assemblies.

The TH6-6 cleaning device first flushes the hose assembly with an anticorrosive emulsion and dries it afterwards with compressed air.



The dry-cleaning systems TH6-10-EL-7 or TH6-10-HL-9-2 fire a Ultra Clean projectile through the length of the hose assembly. In the end protect the finished hose assembly against impurities with plastic caps.

ISO 4406	NAS 1638	SAE 749
11/8	2	
12/9	3	0
13/10	4	1
14/11	5	2
15/12	6	3
16/13	7	4
17/14	8	5
18/15	9	6
19/16	10	
20/17	11	
21/18	12	



Working steps

2.2

ASSEMBLY 2piece ParLock fittings

Cutting, cleaning after cutting and marking
please see “Working Steps for 1piece Parkrimp No-Skive”

Skiving

For the skiving of hydraulic hose, one distinguishes between internal skiving and external skiving. This system is applied for hose types with 4 or 6 spiral reinforcement layers, the so-called Parker ParLock System or Interlock.

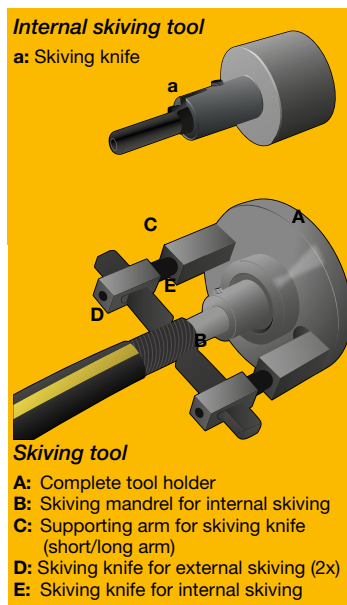

Adjustment of tools for internal skiving

Select the skiving tool according to the manufacturing documents and the hose size. Insert the knife for the internal skiving mandrel into the borehole of the mandrel provided for this purpose and mark it with a lock collar at the straight surface. When adjusting the knife, observe the marking on the internal skiving knife and insert the mandrel into the tool holder.

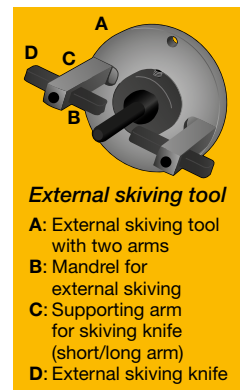

Adjustment of tools for external skiving

Attach the knives in the supporting arm. Select the supporting arm (long or short) depending on the hose size.

Adjust the knives according to the Parker working instructions and insert the tools into the machine. Push the mandrel onto the hose until it is close to the tool (external or internal skiving knife).

Adjustment of the sense of rotation of the machine

Always skive into the direction of the spiral layers. Please observe the operation instructions of the machine.

Cleaning after skiving

All hose types which have been skived externally or internally should be cleaned immediately after skiving. For this purpose we recommend using cleaning plugs which are shot through the hose using compressed air. (e.g. TH6-10-EL-8 or TH6-10-HL-10-2)

In addition to this working step, the finished hose assembly must be cleaned from both ends using pressurised air after the completion of this working step.

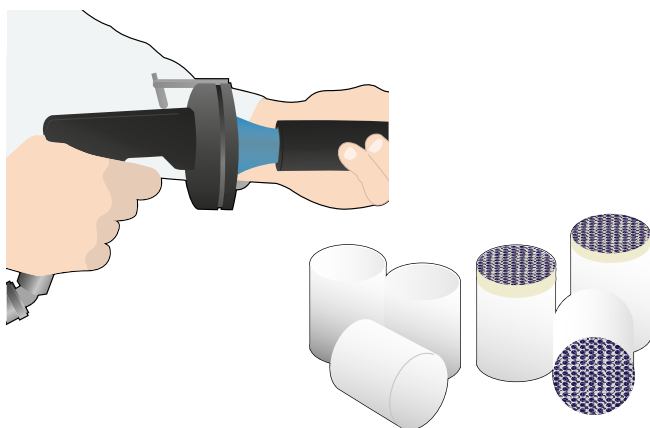

Working steps

Crimping 2piece ParLock fittings

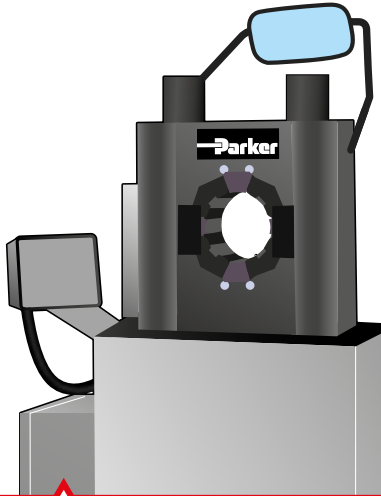

For crimping ParLock fittings V4 series a minimum of 320 tons crimping force is recommended. Min. of 340 tons for V6 series.

- 1) Select the appropriate crimping dies using the crimping diameter chart.
- 2) Before crimping hoses and fittings it must be ensured that you have the most recent crimping dimensions. For crimping dimensions please refer our crimp charts online at www.parker.com/crimpsource-euro
- 3) Insert the dies into the crimping press and set the crimping diameter.
- 4) Place the pre-assembled hose assembly into the crimper and perform the crimping procedure.
- 5) Please observe the operating instructions of the crimper.

! 2piece fittings must not be crimped on Parkrimp crimpers – only with adjustable crimpers.



Make sure that the hose ends are cut squarely. Push the ferrule onto the hose. The cut end of the hose must be clearly visible.

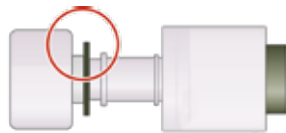

Push the nipple down into the hose until it reaches the stop on the lower groove (plastic ring, fitting shoulder or metal stop). Use Hoze-Oil, if required.

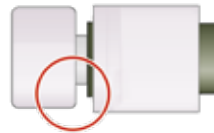

The ferrule must bottom up against the plastic ring or metal stop.

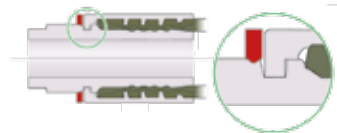

After crimping, the ferrule must be located precisely in the groove of the nipple.

Angle setting

please see "Working Steps for 1piece Parkrimp No-Skive"

Checking for the correct crimping diameter

In case of the ParLock System, the conicity is measured. It is measured at the beginning and the end of the ferrule in 2 measuring planes.

The conicity must be within the tolerance range specified in the Parker specification.



Measurement 1
in the plane of force



Measurement 2
displaced by 90°



Measurement 1
at the beginning and the
end of the ferrule



Measurement 2
at the beginning and
the end of the ferrule
(displaced by 90°)

Testing and cleaning please see "Working Steps for 1piece Parkrimp No-Skive Fittings"



Find the correct crimp specification on the push of a button!

www.parker.com/crimpsource-euro

Working steps

3

INSTALLATION

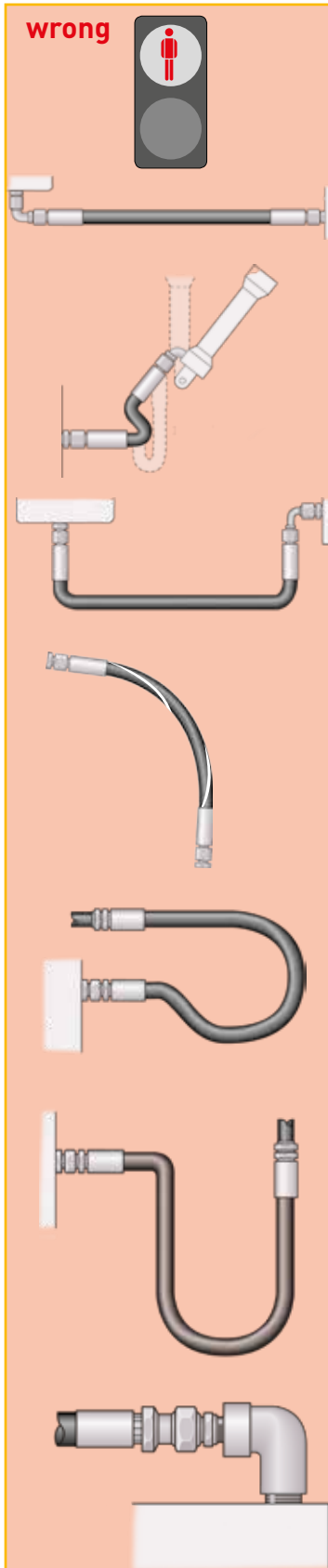

The **routing** of the hose assembly and the environment in which the hose assembly operates directly influence the service life of the hose assembly. The following diagrams indicate the correct routing of hose assemblies that will maximise its service life and assure a safe working functionality.

When hose installation is straight, it must be assured that there is enough slack in the hose to allow for changes in length that occur when pressure is applied. When pressurized, hose that is too short may pull loose from its hose fittings or stress the hose fitting connections, causing premature metallic or seal failures.

The **hose length** must be determined so that the hose assembly has enough slack to allow the system components to move or vibrate without creating tension in the hose.

However, care needs to be taken not to allow too much slack and therefore introduce the risk of the hose snagging on other equipment or rubbing on other components.

Mechanical straining of the hoses needs to be avoided, so the hose must not be bent below its minimum bend radius or twisted during installation. The minimum bending radii for each hose is stated in the hose tables in the catalogue.

The plane of movement must also be considered and the hose routing selected accordingly.

Hose routing also plays an important role on the selection of the hose fittings, as the correct fittings can avoid straining the hoses, unnecessary hose length or multiple threaded joints.

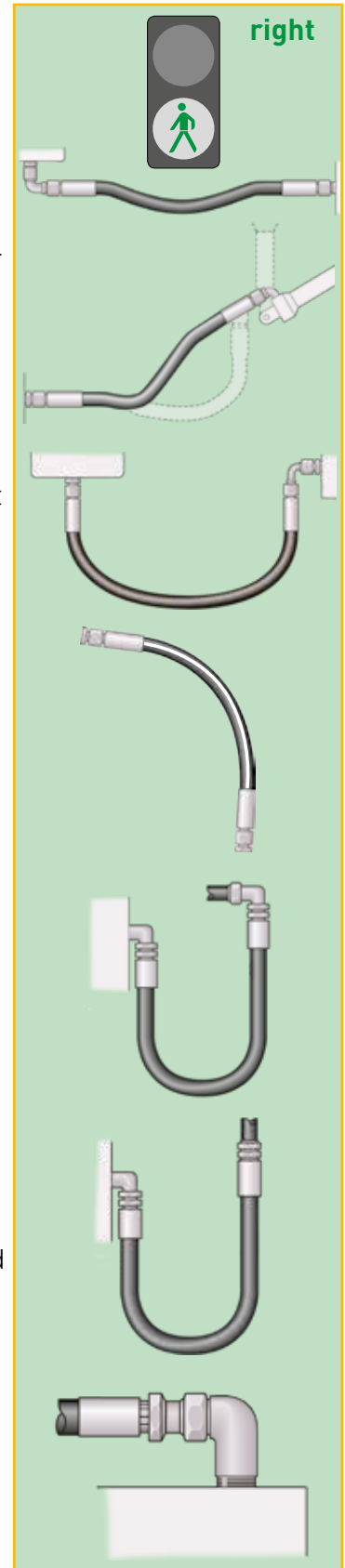

Working steps

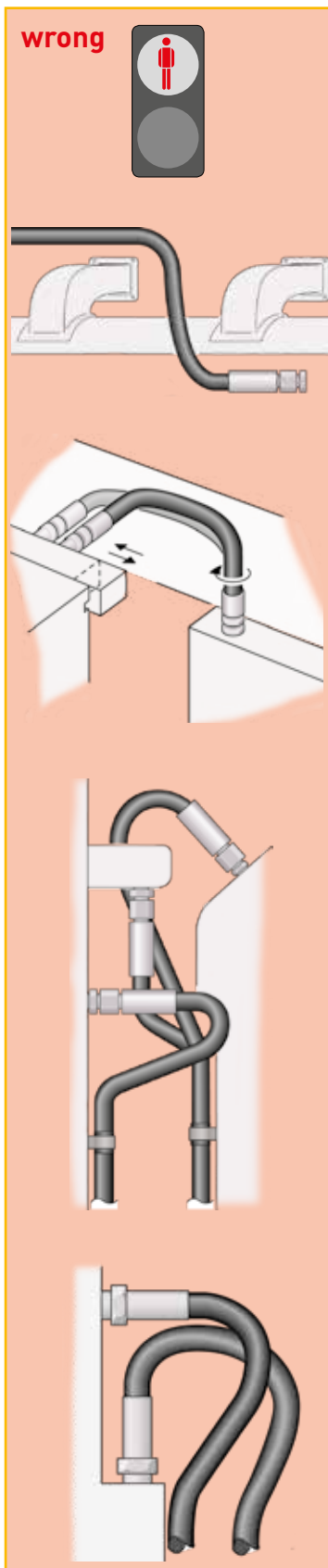

Correct clamping (holding/supporting) of the hose should be exercised to securely route the hose or to avoid the hose contacting surfaces that will cause the hose damage.

It is however, vital that the hose be allowed to keep its functionality as a “flexible-pipe” and not be restricted from changing in length when under pressure.

It should also be noted that hoses for high- and low-pressure lines shall not be crossed or clamped together, as the difference in changes in length could wear the hose covers.

Hose should not be bent in more than one plane. If hose follows a compound bend, it shall be coupled into separate segments or clamped into segments that each flex in only one plane.

Hoses should be kept away from hot parts as high ambient temperatures shorten hose life. Protective insulation may need to be used in unusually high ambient temperature areas.

Whilst the importance of the functionality is preme the aesthetics and practicality of the installation should also be considered in the design.

It should be considered that maintenance might be necessary at some stage in the future, so prohibitive design routings should be avoided.

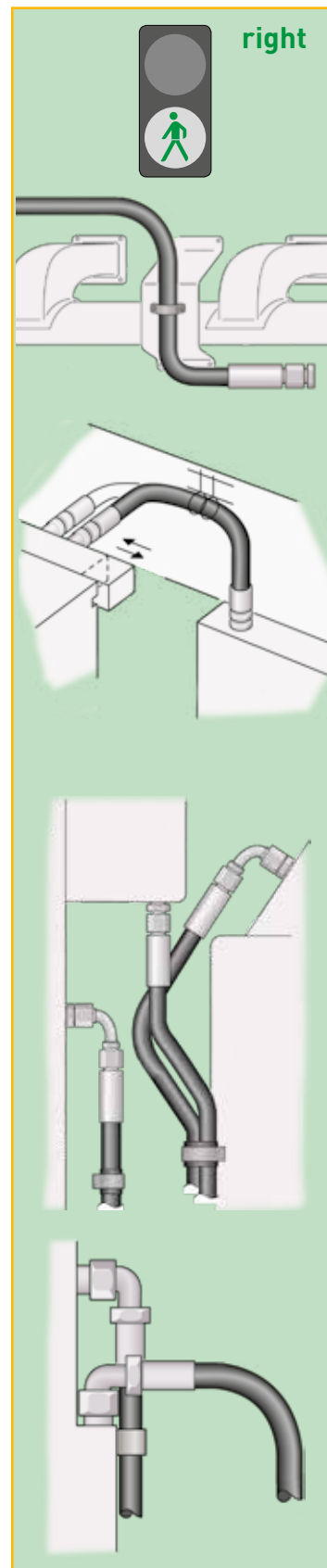

Working steps

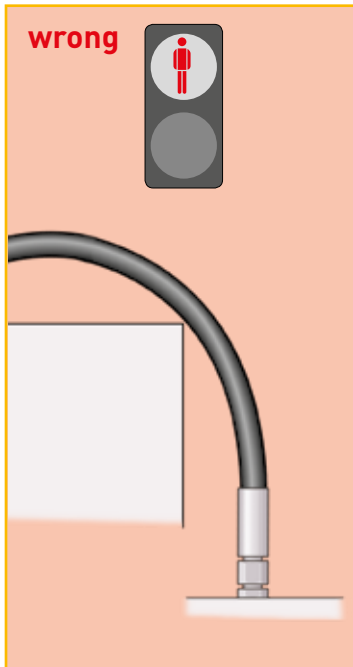

Abrasive influences

In general care should be taken that the hose is not exposed to direct surface contact that will cause abrasive wearing of the outer cover (either hose to object or hose to hose contact). If however, the application is such that this cannot be avoided, either a hose with a higher abrasion resistant hose cover or a protective sleeve need to be used.

Parker **TOUGH COVER** (TC) or **SUPER TOUGH** (ST) covers offer 80 times or respectively 450 times the abrasion resistance of standard rubber covers.



Pollution of hydraulic circuits

Modern hydraulic equipment is becoming highly precise and as such more sensitive, so as a result the importance of a clean working fluid in the system is growing. Because as many as 75 % of hydraulic system failures are caused by contamination of the fluid by solid particles, the initial cleanliness of hydraulic components, as the main source of these contaminants, is vital. With hose assemblies most of the pollution/contaminates enter the hose assembly during its production and mainly during the cutting (or skiving) process.

In order to avoid system failures, all hose assemblies should be cleaned before use (cleaned and plugged before shipping) with suitable cleaning equipment; please see also page **Ea-15** up to **Ea-18**. The level of contamination is defined in three popular norms: ISO4406, ISO4405 or NAS 1638. Most common however, is the ISO 4406, which describes the number and size of solid particles in the hydraulic system by means of a classification value e.g. 16/13.



How to order

Hose and hose fittings

To make ordering Parker products easier, we have itemized the order numbers on this page. This will be especially helpful when you order hose assemblies.

Hose

Example:

462TC-6

462TC-6 → Hose type

462TC-6 → Hose inside diameter in size



Hose fittings

Example:

1CA48-12-6

1CA48-12-6 → Fitting

1CA48-12-6 → End configuration

1CA48-12-6 → Parker fitting series

1CA48-12-6 → Thread or tube size

1CA48-12-6 → Hose / fitting size

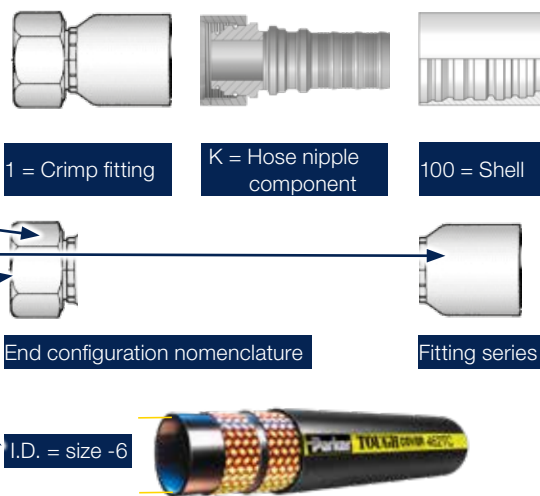

Material and specification:

- Without suffix: steel, zinc plated, Cr6-free
- B: brass
- C: stainless steel
- K: without a plastic ring
- SM: metric hexagon dimension

The content of the hose crimping tables shows the standard part numbers. For the availability of non standard parts and materials please contact your local Parker service centre.

Hose assemblies



Hose assemblies

Example:

P462TCCACF12106-1000-0-SG900

- R** → Low pressure Push-Lok fittings series 82
- P** → Parkrimp No-Skive fittings series 26, 48
- D** → Parkrimp No-Skive fittings series 46
- F** → Parkrimp No-Skive fittings series 43, 70, 73, 77
- E** → Parlock Skive fittings series VS
- V** → Parlock Skive fittings series V4, V5, WB
- S** → Parlock Skive fittings series V6
- T** → Parkrimp No-Skive fittings series IF

P462TCCACF12106-1000-0-SG900

Hose type

P462**T**CACF12106-1000-0-SG900

Fitting 1 end configuration

P462TC**C**ACF12106-1000-0-SG900

Fitting 2 end configuration

P462TCCAC**F**12106-1000-0-SG900

Fitting 1 thread or tube size

P462TCCACF**12**106-1000-0-SG900

Fitting 1 thread or tube size

P462TCCACF12**106**-1000-0-SG900

Hose / fitting size

P462TCCACF1210**6**-1000-0-SG900

Hose assembly length in mm

P462TCCACF12106-**1000**-0-SG900

Displacement angle is relevant when the hose assembly has bent fittings

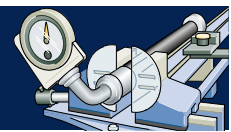

P462TCCACF12106-1000-**0**-SG900

Accessory (e.g. spring guard 900 mm length)

P462TCCACF12106-1000-0-**SG900**

- SG** → Spring Guard
- AG** → Armour Guard
- AS/PS** → Partek Nylon protective sleeve
- FS** → Fire Sleeves
- HG** → PolyGuard-Hose Protector
- PG** → Parkoil-Hose Protector
- DM** → Minesleeve

Explanation of the example

Hose assembly with hose 462TC in size -6 and fitting series 48.

Hose assembly length 1000 mm.

Fitting 1: end configuration CA has a 12 mm pipe diameter and has a size -6 hose nipple

Fitting 2: end configuration CF has a 10 mm pipe diameter and has a size -6 hose nipple

The displacement angle for this combination is 0 degrees. On request a displacement angle can be specified for the bent fitting in relation with the hose curvature. A protection sleeve as a spring guard in length 900 mm is on the hose assembly.

Identifying fitting types

Determining sealing mechanisms

In general fittings can be identified by their visual appearance, their sealing surface/sealing type or by their thread type/form. Viewing the following pages, the visual identification will be self explanatory. The sealing mechanism and the method of thread identification, however, needs further explanation

Thread interface

The sealing is assured by the flattening of the edges of the threads when the male is screwed into the female fitting. Typically the front of the male fittings is narrower than the back of the fittings – often referred to as tapered threads.

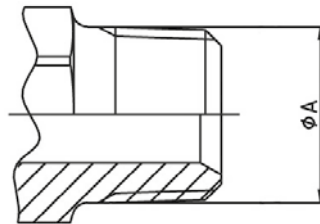

O-ring

The O-ring on the male is compressed against the corresponding female and assures the seal. This type of sealing mechanism should be the preferred choice for high-pressure applications. be convex or concave (seat) on the male or in the head of the pipe of the female as shown.

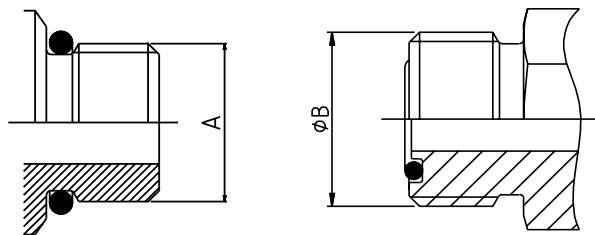

Matching angle or metal-to-metal joint

Sealing takes place where the two angled faces of the male and corresponding female meet and are wedged into one another by the tightening of the threaded nut. The sealing surfaces can either be convex or concave (seat) on the male or in the head of the pipe of the female as shown.

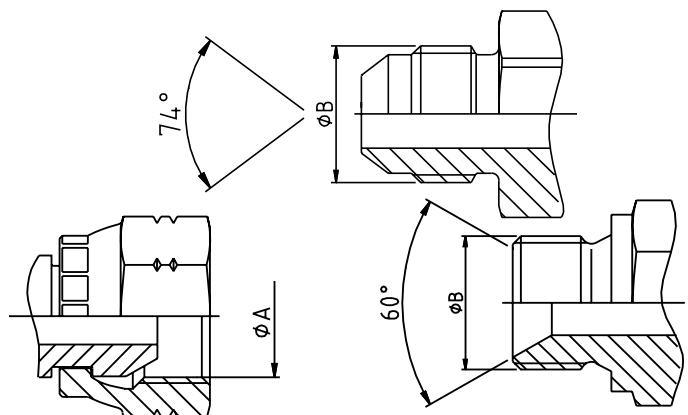

Matching angle with O-ring

These fittings combine the functionality of both the matching angle seal with the O-ring. The O-ring is in the angled sealing surface of the fitting so that when the threaded male and female are screwed together the sealing surfaces wedge together and at the same time deform the O-ring between them.

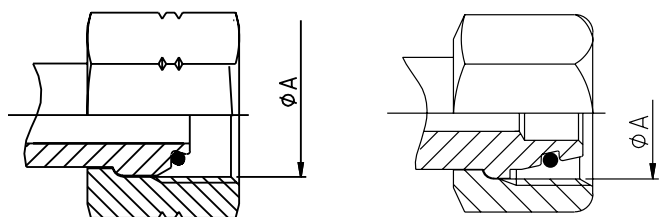

Determining the thread type

In general of the threads of various fittings look similar and hinder the easy identification of the thread. To assure the correct identification, the threads must be measured and compared to the tables listed in the following section.

Thread gauge

Using a thread gauge, the number of threads per inch can be determined.

Holding the gauge and coupling threads in front of a lighted background helps to obtain an accurate measurement.

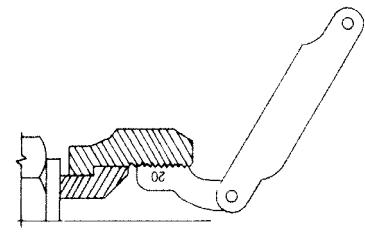
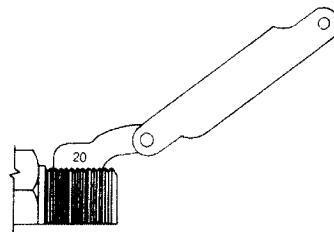

Caliper measure

A vernier caliper should be used to measure the thread diameter of the largest point. (Outside diameter (O.D.) of male threads – Inside Diameter (I.D.) of female threads.)

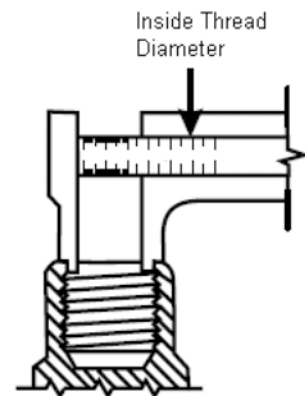
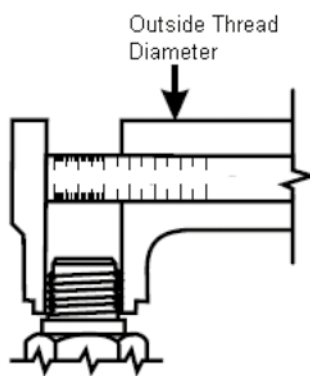

DIN (DIN – Deutsches Institut für Normung)

Often referred to as metric fittings, these fittings seal using the angled sealing surfaces (metal-to-metal) or the combination of metal-to-metal with O-rings. They are available in **very light (LL)**, **light (L)** or **heavy series (S)**. The sealing face angles are either 24° with or without O-rings, or 24°/60° universal cones. Identification is made by measuring the thread size and also the tube outside diameter.

Thread
 Defined by the outside diameter and the pitch (distance between 2 crests of the thread) example: M22x1.5 - pitch of 1.5mm.

DIN 24° light (L) and heavy series (S) with O-ring

The male has a 24° sealing angle cone seat with straight metric threads.

The female has a 24° convex cone with O-ring and a swivel straight metric threaded nut.

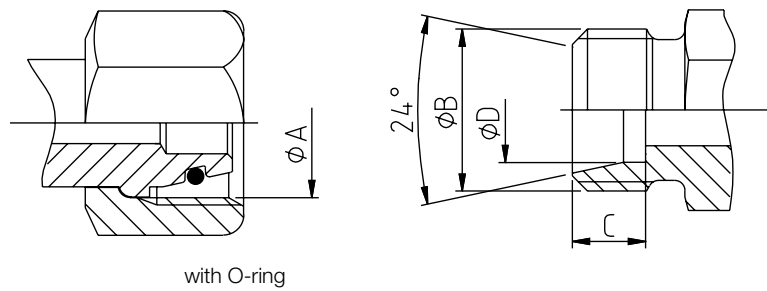

Standard: **ISO 12151-2, ISO 8434-1, ISO 8434-4**

(Previously DIN 20 078 Part 4, 5, 8, 9)

Light series Parker end configurations: **CA, CE, CF, D0**

Heavy series Parker end configurations: **C9, 0C, 1C, D2**

Tube O.D. (mm)	Spec.	Thread metric	ØA (mm)	ØB (mm)	C (mm)	ØD (mm)
6.00	6L	M12X1.5	10.50	12.00	7.00	6.20
6.00	6S	M14X1.5	12.50	14.00	7.00	6.20
8.00	8L	M14x1.5	12.50	14.00	7.00	8.20
8.00	8S	M16x1.5	14.50	16.00	7.00	8.20
10.00	10L	M16x1.5	14.50	16.00	7.00	10.20
10.00	10S	M18x1.5	16.50	18.00	7.50	10.20
12.00	12L	M18x1.5	16.50	18.00	7.00	12.20
12.00	12S	M20x1.5	18.50	20.00	7.50	12.20
14.00	14S	M22x1.5	20.50	22.00	8.00	14.20
15.00	15L	M22x1.5	20.50	22.00	7.00	15.20
16.00	16S	M24x1.5	22.50	24.00	8.50	16.20
18.00	18L	M26x1.5	24.50	26.00	7.50	18.20
20.00	20S	M30x2	27.90	30.00	10.50	20.20
22.00	22L	M30x2	27.90	30.00	7.50	22.20
25.00	25S	M36x2	33.90	36.00	12.00	25.20
28.00	28L	M36x2	33.90	36.00	7.50	28.20
30.00	30S	M42x2	39.90	42.00	13.50	30.20
35.00	35L	M45x2	42.90	45.00	10.50	35.30
38.00	38S	M52x2	49.90	52.00	16.00	38.30
42.00	42L	M52x2	49.90	52.00	11.00	42.30

BSP (British Standard Pipe)

Also referred to as Whitworth threads, the BSP thread type fittings seal use metal-to-metal angled surfaces or a combination of metal-to-metal and an O-ring. The angle of the sealing surfaces is 60° for both forms.

There are two popular thread forms: British Standard Pipe Parallel (BSPP) and British Standard Pipe Tapered (BSPT).

Thread

Identification is made by measuring the outside diameter of the thread and the number of threads per inch (25.4 mm)

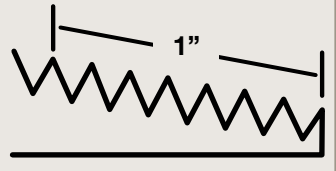

BSPP

metal-to-metal without O-ring

Standard: **BS5200, ISO 8434-6**

Parker end configurations:

92, B1, B2, B4, D9

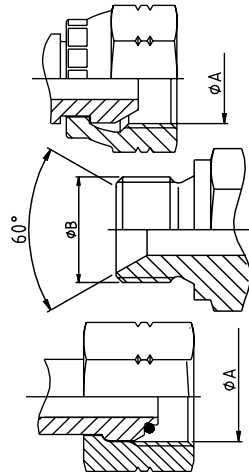

Tube I.D./O.D. (mm)	Size	Thread BSP	ØA (mm)	ØB (mm)
6/10	-2	1/8x28	8.60	9.70
8/13	-4	1/4x19	11.50	13.20
12/17	-6	3/8x19	14.90	16.70
15/21	-8	1/2x14	18.60	20.90
18/23	-10	5/8x14	20.60	22.90
20/27	-12	3/4x14	24.10	26.40
26/34	-16	1x11	30.30	33.20
33/42	-20	1-1/4x11	38.90	41.90
40/49	-24	1-1/2x11	44.90	47.80
50/60	-32	2x11	56.70	59.60

BSPP

metal-to-metal with O-ring

Standard: **ISO 12151-6,**

ISO 8434-6

Parker end configurations:

EA, EB, EC, EE, D9

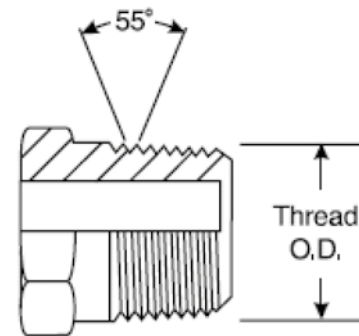

Tube I.D./O.D. (mm)	Size	Thread BSP	ØA (mm)
5/10	-2	1/8x28	9.73
8/13	-4	1/4x19	13.16
12/17	-6	3/8x19	16.66
15/21	-8	1/2x14	20.96
20/27	-12	3/4x14	26.44
26/34	-16	1x11	33.25
33/42	-20	1-1/4x11	41.91
40/49	-24	1-1/2x11	47.80
50/60	-32	2x11	59.61

BSPT

fittings seal through the thread interface mechanism. Care should be taken not to confuse the BSPT fitting with the NPTF male fitting. BSPT has a 55° thread angle. NPTF has 60° thread angle.

Parker end configurations: **91**

BSP flat seal

These fittings have BSP parallel threads but the sealing surface is flat. The seal is made when the composite seal is compressed against the female flat face.

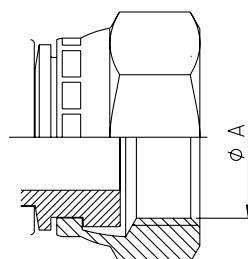

Tube I.D./O.D. (mm)	Size	Thread BSP	ØA (mm)
6/10	-2	1/8x28	8.6
8/13	-4	1/4x19	11.5
12/17	-6	3/8x19	14.9
15/21	-8	1/2x14	18.6
18/23	-10	5/8x14	20.6
20/27	-12	3/4x14	24.1
26/34	-16	1x11	30.3

Parker end configurations:

B5, B6, B7

NPTF / SAE JIC 37°

This type of fitting uses the thread interface to seal and as such has a tapered thread that deforms and forms the seal. They have 30° sealing angle surfaces, forming a 60° inverted (concave) seat. The fittings are most frequently seen on machines of US origin.

Dryseal american standard taper pipe thread (NPTF)

The NPTF male will mate with the NPTF, NPSF, or NPSM females. Care should be taken not to confuse the NPTF fitting with the BSPT male fitting. NPTF fittings have a 60° thread angle. BSPT has a 55° thread angle.

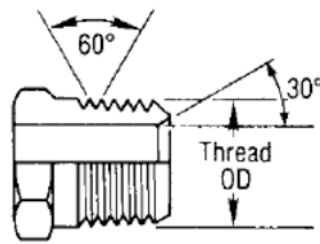

ØA dimension is measured on the 4th pitch of the thread

Size	Thread NPTF	ØA (mm)	ØB (mm)
-2	1/8x27	10.24	8.73
-4	1/4x18	13.61	11.90
-6	3/8x18	17.05	15.90
-8	1/2x14	21.22	19.05
-12	3/4x14	26.56	24.60
-16	1x11.5	33.22	30.95
-20	1-1/4x11.5	41.98	39.69
-24	1-1/2x11.5	48.05	45.24
-32	2x11.5	60.09	57.15

Standard: **SAE J516**

Parker end configurations: **01**

SAE JIC 37°

Commonly referred to as JIC fittings, these metal-to-metal sealing type fittings have a 37° flare (sealing surface angle) and straight United National Fine Threads (UNF).

The original design specification for the fittings comes from the Society of Automotive Engineers (SAE) and these fittings are the most common American fitting types in Europe. Parker JIC hose fittings are fully compatible with Parker Triple-Lok Tube Fittings and adapters.

Standard: **ISO 12151-5, ISO8434-2, SAE J516**

Parker end configurations: **03, 06/68, 37/3V, 39/3W, 41/3Y, L9**

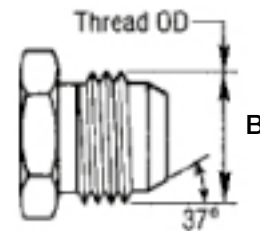
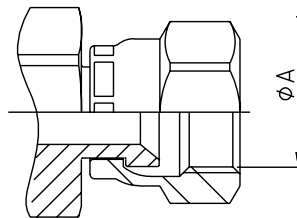

Tube O.D. (inch)	Tube O.D. (mm)	Thread UNF	Size	ØA (mm)	ØB (mm)
3/16		3/8x24	-3	8.60	9.50
1/4	6	7/16x20	-4	10.00	11.10
5/16	8	1/2x20	-5	11.60	12.70
3/8	10	9/16x18	-6	13.00	14.30
1/2	12	3/4x16	-8	17.60	19.10
5/8	14-15-16	7/8x14	-10	20.50	22.20
3/4	18-20	1-1/16x12	-12	24.60	27.00
7/8	22	1-3/16x12	-14	28.30	30.10
1	25	1-5/16x12	-16	31.30	33.30
1-1/4	30-32	1-5/8x12	-20	39.20	41.30
1-1/2	38	1-7/8x12	-24	45.60	47.60
2		2-1/2x12	x32	61.50	63.50

ORFS

O-ring face seal (ORFS)

ORFS fittings are becoming the most popular international fitting type used on global OEM machines due to their high level of sealing and their good vibration resistance. The fittings use the O-ring compression mechanism to seal.

The female fittings have flat faces and straight threaded UNF swivel nuts. The male fittings have the O-ring in a groove in the flat face. Seen as a major advantage, these fittings offer the possibility to build the hose assemblies into fixed distances/spaces, without having to move back other system components due the flat faces of the male and female fittings – the hose assembly can be slotted in.

Standard: **ISO 12151-1,**
ISO8434-3, SAE J516

Parker end configurations:
JC, JM/J0, JS, JU,
J1, J3, J5, J7, J9

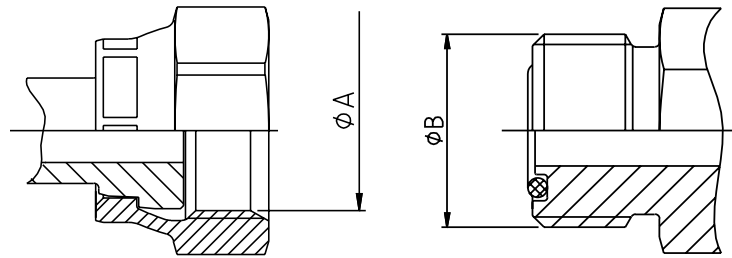

Tube O.D. (inch)	Tube O.D. (mm)	Thread UNF	Size	ØA (mm)	ØB (mm)
1/4	6	9/16x18	-4	13.00	14.20
3/8	10	11/16x16	-6	15.90	17.50
1/2	12	13/16x16	-8	19.10	20.60
5/8	16	1x14	-10	23.80	25.40
3/4	20	1-3/16x12	-12	28.20	30.10
1	25	1-7/16x12	-16	34.15	36.50
1-1/4	32	1-11/16x12	-20	40.50	42.90
1-1/2	38	2x12	-24	48.80	50.80

Flanges ISO 6162-1 and ISO 6162-2

Flange fittings

ISO 6162-1 and ISO 6162-2

The 4-bolt split flange (or full flange) fitting is used worldwide for connecting high-pressure hoses typically to pumps, motors and cylinders, where the hose assemblies are subjected to large pressure loadings.

The sealing mechanism is through compression of the O-ring in the face of the flange head against the surface of the port/ connection.

The flange fittings are generally separated into two pressure classes referred to as 21.0 MPa/ 3000 psi (SFL) or 42.0 MPa/ 6000 psi (SFS). ISO 12151-3 refers to the flange fittings to as 21.0 MPa/ 3000 psi (SFL) or 42.0 MPa/ 6000 psi (SFS). In addition to these flanges, customer-specific Komatsu® and CATERPILLAR® flanges can also be found in the market.

ISO 6162-1 (21.0 MPa/ 3000 psi)
Parker end configurations:
15, 16, 17, 19, P5, P7, P9

ISO 6162-1 (35.0 MPa/ 5000 psi)
Parker end configurations:
4A, 4F, 4N

ISO 6162-2 (42.0 MPa/ 6000 psi)
Parker end configurations:
6A, 6F, 6N, PA, PF, PN, 89

Caterpillar flange Parker end configurations: **XA, XF, XG, XN**

- Standard ISO 6162-1 for 21.0 MPa/ 3000 psi to 35.0 MPa/ 5000 psi max., depending on size
- High Pressure ISO 6162-2 for 42.0 MPa/ 6000 psi max. regardless of size

Flange (inch)	Size	ISO 6262-1 MPa / psi	ISO 6162-2 MPa / psi
1/2	-8	34.5 / 5000	41.3 / 6000
3/4	-12	34.5 / 5000	41.3 / 6000
1	-16	34.5 / 5000	41.3 / 6000
1-1/4	-20	27.5 / 4000	41.3 / 6000
1-1/2	-24	20.7 / 3000	41.3 / 6000
2	-32	20.7 / 3000	41.3 / 6000

Note: 35.0 MPa/ 5000 psi in size -20/-24/-32 with 4A,4F and 4N fittings and 50H flange halves.

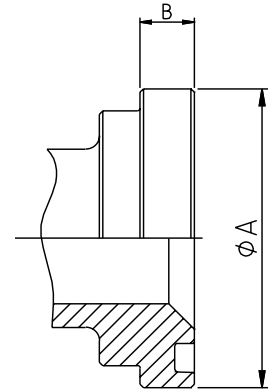

ISO 6162-1 – 21.0 MPa/ 3000 psi

Flange (inch)	Size	ØA (mm)	B (mm)	O-Ring
1/2	-8	30.18	6.73	18.64x3.53
3/4	-12	38.10	6.73	24.99x3.53
1	-16	44.45	8.00	32.92x3.53
1-1/4	-20	50.80	8.00	37.69x3.53
1-1/2	-24	60.33	8.00	47.22x3.53
2	-32	71.42	9.53	56.74x3.53
2-1/2	-40	84.12	9.53	69.44x3.53
3	-48	101.60	9.53	85.32x3.53

ISO 6162-2 – 42.0 MPa/ 6000 psi

Flange (inch)	Size	ØA (mm)	B (mm)	O-Ring
1/2	-8	31.75	7.75	18.64x3.53
3/4	-12	41.28	8.76	24.99x3.53
1	-16	47.63	9.53	32.92x3.53
1-1/4	-20	53.98	10.29	37.69x3.53
1-1/2	-24	63.50	12.57	47.22x3.53
2	-32	79.38	12.57	56.74x3.53

CATERPILLAR®

Flange (inch)	Size	ØA (mm)	B (mm)	O-Ring
3/4	-12	41.28	14.22	25.40x5.00
1	-16	47.63	14.22	31.90x5.00
1-1/4	-20	53.98	14.22	38.20x5.00
1-1/2	-24	63.50	14.22	44.70x5.00

Komatsu®

Flange (inch)	Size	ØA (mm)	B (mm)	O-Ring
5/8	-10	34.25	6.00	21.7x3.5

Although not in the SAE or the ISO standard the size -10 (5/8) flange head is gaining popularity. This flange is often found on Komatsu equipment or hydrostatic drives in agricultural machines.

4-bolt split flange

4-bolt split flange

A 4-bolt split flange is used to attach the flange fittings to their ports.

- Standard ISO 6162-1 for 21.0 MPa (3000 psi) to 35.0 MPa (5000 psi) max., depending on size
- High Pressure ISO 6162-2 for 42.0 MPa (6000 psi) max., regardless of size

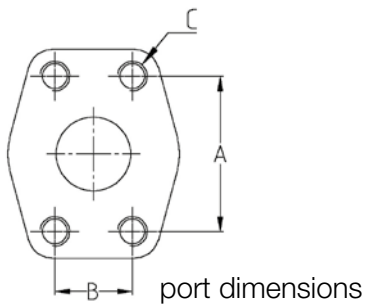

ISO 6162-1 – 21.0 MPa (3000 psi)

Flange (inch)	Size	A (mm)	B (mm)	C	
				(inch)	(metr.)
1/2	-8	38.1	17.5	5/16x18	M8x1.25
3/4	-12	47.6	22.3	3/8x16	M10x1.5
1	-16	52.4	26.2	3/8x16	M10x1.5
1-1/4	-20	58.7	30.2	7/16x14	M10x1.5
1-1/2	-24	69.9	35.7	1/2x13	M12x1.75
2	-32	77.8	42.8	1/2x13	M12x1.75*

ISO 6162-2 – 42.0 MPa (6000 psi)

Flange (inch)	Size	A (mm)	B (mm)	C	
				(inch)	(metr.)
1/2	-8	40.5	18.2	5/16x18	M8x1.25
3/4	-12	50.8	23.8	3/8x16	M10x1.5
1	-16	57.2	27.8	7/16x14	M12x1.75
1-1/4	-20	66.7	31.8	1/2x13	M12x1.75*
1-1/2	-24	79.4	36.5	5/8x11	M16x2
2	-32	96.8	44.4	3/4x10	M20x2.5

*M14x2 still used in the market but no longer in accordance with ISO 6162

It is a well-known fact that rubber properties deteriorate during the time of storage and service. A system of hose age control should be maintained to ensure that hose is used as long as it retains full capabilities for rendering the intended service.

However, it is impossible to advise the ideal storage period and service life of rubber hose as it is subject to a variety of factors which may affect the rubber characteristics and the suitability for use.

That is also why various standardization committees take very different approaches to rubber hose storage period and service life. The main national and international standards defining rules for rubber hose storage are the following:

DIN 20066

Fluid power systems – hose assemblies – dimensions, requirements

Specifies bulk hose shelf life and hose assembly storage period and service life:

- The shelf life of bulk hose before assembling must not exceed 4 years.
- The service life of a hose assembly, incl. any period of storage, should not exceed 6 years.
- The period of storage of a hose assembly must not exceed 2 years.

Bulk Hose

Shelf life
– max. 4 years

Hose Assembly

Service life – max. 6 years
Storage
max. 2 years

ISO 17165-2 / SAE J1273

Hydraulic fluid power – hose assemblies – recommended practices for hydraulic hose assemblies

The specified max. shelf life of bulk hose or a hose assembly is 10 years (40 quarters) from the date of manufacture (vulcanization) of the hose, provided it has been stored in accordance with ISO 2230 (Rubber products - Guidelines for storage) and passes visual inspection and if need be also a proof pressure test. If visual inspection gives rise to any doubts as to the functionality of the hose (cracks in the cover or tube after hose flexing, excessive stiffness, reinforcement rust etc.), a proof pressure test should be carried out before use or the hose should be scrapped.

OEM regulations

In addition to these national and international standards, also some Original Equipment Manufacturers (OEMs) have their own regulations for age of hose used for production of hose assemblies.

We recommend generally observe the regulations relevant for your country or ISO 17165-2 (if there is no domestic regulation), plus the regulation of your customer's country or of your OEM customer in the extent in which they are more demanding.

BS 5244

Recommendations for application, storage and life expiry of hydraulic rubber hoses and hose assemblies

Specifies tests needed for various storage periods of hose (in bulk or hose assembly):

- Storage period does not exceed 3 years – no tests needed.
- Storage period is between 3 and 5 years – proof pressure test needed.
- Storage period is between 5 and 8 years – proof pressure, burst, impulse, cold flexibility and electrical tests needed.
- Bulk hose or a hose assembly older than 8 years – must be scrapped.

For hose assembly service life no explicit limits are specified, whereas it is recommended to establish rules for each particular equipment and application on the basis of records taken from the real service.

Hint

German and the British standards are the most rigorous.

ISO 8331

Rubber and plastic hoses and hose assemblies – guide to selection, storage, use and maintenance

Specifies storage periods similar to DIN 20066 – bulk hose max. 4 years, a hose assembly max. 2 years. If the storage exceeds these limits the hose must be inspected and tested (tests are not specified). Hose assembly service life is not specified.

Best practices

Hoses storage – best practices

Store hoses and hose assemblies in a cool, dark and dry room with capped ends in closed boxes (preferably in the original Parker packaging) and in the manner facilitating inspection of the hose condition and the first-in first-out (FIFO) inventory control system.

The main factors determining the hose storage are:

a) Temperature

Preferably between 15 °C and 25 °C, without rapid and frequent fluctuation.

b) Humidity

Preferably not higher than 65 %, protect hose against moisture and avoid atmospheric humidity condensation.

c) Heat

Store hose away from heat sources.

d) Light

Protect hose against direct sun light, light of discharge lamps and other ultraviolet sources.

e) Corrosive liquids and fumes

Do not store in the same room with corrosive chemicals.

f) Ozone

Avoid using high power electrical equipment and electrical spark sources in the storage room.

g) Oils and greases

Avoid direct contact.

h) Space and bends

Keep hose in stress-free shape never bent below the min. bend radius.

i) Electrical and magnetic fields

Store hose away from powerful electric transformers, motors and generators that could induce current in the hose metal reinforcement.

j) Rodents and insects

Protect against rodents and insects.

Fittings storage – best practices

For storing fittings the same rules as for hose are applicable (especially for fittings with rubber sealing), in addition:

a) Mismatching and confusing

Avoid unnecessary repacking and store fittings in clearly marked closed containers (preferably in the original Parker packaging).

b) Damage of threads and sealing surfaces

Avoid unnecessary reloading and handling.

c) Fittings with O-rings

Assure that storage period of fittings with O-rings or other rubber sealing does not exceed 2 years (remember: first in-first out) and make sure that hose assemblies or hose fittings with O-rings will be stored in a cool, dry and dark room.

d) Caps

Hose assemblies fittings should be capped against damage and contamination.



Safety first!

A hydraulic hose assembly is a power component and may cause property damage, personal injury or death!

WARNING: Injuries in which hydraulic or other liquid is involved must be treated without delay and not the same way as an ordinary injury!

1. High pressure fluid injection can be almost invisible, leaking from a pinhole, but it can pierce the skin deep into the muscle!
2. If a fluid-injection accident occurs, search immediately for a medical treatment by a doctor!
3. Don't touch pressurized hydraulic hose assemblies and don't look at them from a short distance – especially not close to fittings!
4. Secure ends of hydraulic assemblies with high pulsing pressure and all high pressure air hose assemblies against blow-off of the hose from the fitting with appropriate whip restraints!
5. Stay out of hazardous areas while testing hose assemblies under pressure and wear proper protective clothing and goggles!

We in Parker are making all efforts to develop, manufacture and deliver defect-free, durable and safe products and services – starting from integrated design and testing of all components through sharing our know-how with our customers and providing them with comprehensive support and training.



Please also make all efforts on your side to provide reliable and safe hose assemblies to your customers and forward to them the know-how you acquired, whether from us or due to your own unique experience, especially as regards the proper use and maintenance of hose assemblies.

Avoid injury to yourself and others by following these important rules

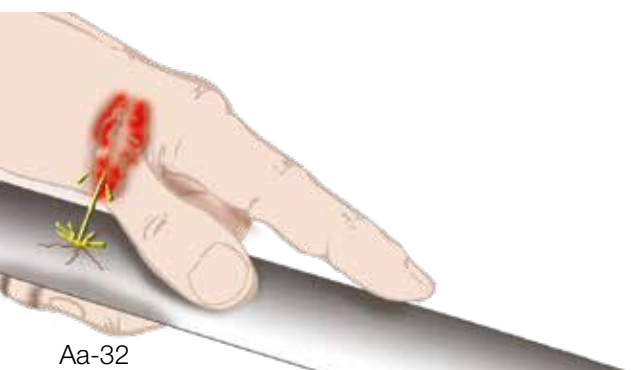

Carefully read and observe especially the following sections of this catalogue

- For selection of proper hose and fittings:
 - Safe Hose Assembly Working Steps (pages **Aa-9** ff)
 - Technical Data (pages **Aa-2** ff)
- For manufacturing of hose assemblies:
 - Working Steps for 1piece **Parkrimp** Fittings (pages **Aa-12** ff)
 - Working Steps for 2piece **ParLock** Fittings (pages **Aa-15** ff)
 - Crimp Source (page **Ed-1**)
- For storing, packing and handling:
 - Hose and Fittings Storage (pages **Aa-34** ff)
- For installation on machines:
 - Routing / Installation / Environmental Influences (pages **Aa-17** ff)
- Inspection, maintenance and replacement:
 - Preventive Maintenance Program (page **Aa-26**)
- **READ CAREFULLY AND OBSERVE:**
 - **Parker Safety Guide** for Selecting and Using Hose, Tubing, Fittings and Related Accessories (pages **Aa-38** ff)
- **INVESTIGATE, STUDY AND OBSERVE all relevant international and national standards and directives** of your local trade, technical and work safety associations, such as:
 - **ISO 17165-1** *Hydraulic Fluid Power – Hose Assemblies*
 - **ISO 17165-2** *Hydraulic Fluid Power – Hose Assemblies*
 - **ISO 4413** *Hydraulic fluid power – General rules and safety requirements for systems and their components*
 - **SAE J1273** *Recommended Practices for Hydraulic Hose Assemblies*

Hose Hint

There are several analogies between hydraulic and electric systems and it is not inappropriate to compare high-pressure hydraulic hoses to high-voltage electrical cables and to advise to regard and handle them with similar caution and care!

In Germany

- **DGUV Regel 113-020** *Hydraulik-Schlauchleitungen und Hydraulik-Flüssigkeiten – Regeln für den sicheren Einsatz*
- **FA 015** *Hydraulik-Schlauchleitungen Prüfen und Auswechseln*
- **DGUV Information 209-070** *Sicherheit bei der Hydraulik-Instandhaltung*

In UK

- **BFPDA D8** *Quality Control Procedures and Requirements for BFPDA Distributors*
- **BFPDA D14** *A Simple Rule for Re-ending Hydraulic Hose Assemblies – Don't*
- **BFPDA P47** *Guidelines for the Use of Hydraulic Fluid Power Hose and Hose Assemblies*

Parker safety guide

Parker safety guide for selecting and using hose, tubing, fittings and related accessories Parker Publication No. 4400-B.1 / Revised: September, 2015



WARNING

Failure or improper selection or improper use of hose, tubing, fittings, assemblies, valves, connectors, conductors or related accessories ("Products") can cause death, personal injury and property damage. Possible consequences of failure or improper selection or improper use of these Products include but are not limited to:

- Fittings thrown off at high speed.
- High velocity fluid discharge.
- Explosion or burning of the conveyed fluid.
- Electrocutation from high voltage electric powerlines.
- Contact with suddenly moving or falling objects that are controlled by the conveyed fluid.
- Injections by high-pressure fluid discharge.
- Dangerously whipping Hose.
- Tube or pipe burst.
- Weld joint fracture.
- Contact with conveyed fluids that may be hot, cold, toxic or otherwise injurious.
- Sparking or explosion caused by static electricity buildup or other sources of electricity.
- Sparking or explosion while spraying paint or flammable liquids.
- Injuries resulting from inhalation, ingestion or exposure to fluids.

Before selecting or using any of these Products, it is important that you read and follow the instructions below. No product from any division in Fluid Connector Group is approved for in-flight aerospace applications. For hoses and fittings used in in-flight aerospace applications, please contact Parker Aerospace Group

1.0 GENERAL INSTRUCTIONS

Scope: This safety guide provides instructions for selecting and using (including assembling, installing, and maintaining) these Products. For convenience, all rubber and/or thermoplastic products commonly called "hose" or "tubing" are called "Hose" in this safety guide. Metallic tube or pipe are called "tube". All assemblies made with Hose are called "Hose Assemblies". All assemblies made with Tube are called "Tube Assemblies". All products commonly called "fittings", "couplings" or "adapters" are called "Fittings". Valves are fluid system components that control the passage of fluid. Related accessories are ancillary devices that enhance or monitor performance including crimping, flaring, flanging, presetting, bending, cutting, deburring, swaging machines, sensors, tags, lockout handles, spring guards and associated tooling. This safety guide is a supplement to and is to be used with the specific Parker publications for the specific Hose, Fittings and Related Accessories that are being considered for use. Parker publications are available at www.parker.com. SAE J1273 (www.sae.org) and ISO 17165-2 (www.ansi.org) also provide recommended practices for hydraulic Hose Assemblies, and should be followed.

1.1 Fail-Safe: Hose, Hose Assemblies, Tube, Tube Assemblies and Fittings can and do fail without warning for many reasons. Design all systems and equipment in a fail-safe mode, so that failure of the Hose, Hose Assembly, Tube, Tube Assembly or Fitting will not endanger persons or property.

1.2 Distribution: Provide a copy of this safety guide to each person responsible for selecting or using Hose, Tube and Fitting products. Do not select or use Parker Hose, Tube or Fittings without thoroughly reading and understanding this safety guide as well as the specific Parker publications for the Products.

1.3 User Responsibility: Due to the wide variety of operating conditions and applications for Hose, Tube and Fittings. Parker does not represent or warrant that any particular Hose, Tube or Fitting is suitable for any specific end use system. This safety guide does not analyze all technical parameters that must be considered in selecting a product. The user, through its own analysis and testing, is solely responsible for:

- Making the final selection of the Products.
- Assuring that the user's requirements are met and that the application presents no health or safety hazards.
- Following the safety guide for Related Accessories and being trained to operate Related Accessories.
- Providing all appropriate health and safety warnings on the equipment on which the Products are used.
- Assuring compliance with all applicable government and industry standards.

1.4 Additional Questions: Call the appropriate Parker technical service department if you have any questions or require any additional information. See the Parker publication for the Products being considered or used, or call 1-800-CPARKER, or go to www.parker.com, for

telephone numbers of the appropriate technical service department.

2.0 HOSE, TUBE AND FITTINGS SELECTION INSTRUCTIONS

2.1 Electrical Conductivity: Certain applications require that the Hose be nonconductive to prevent electrical current flow. Other applications require the Hose and the Fittings and the Hose/Fitting interface to be sufficiently conductive to drain off static electricity. Extreme care must be exercised when selecting Hose, Tube and Fittings for these or any other applications in which electrical conductivity or nonconductivity is a factor. The electrical conductivity or nonconductivity of Hose, Tube and Fittings is dependent upon many factors and may be susceptible to change. These factors include but are not limited to the various materials used to make the Hose and the Fittings, Fitting finish (some Fitting finishes are electrically conductive while others are nonconductive), manufacturing methods (including moisture control), how the Fittings contact the Hose, age and amount of deterioration or damage or other changes, moisture content of the Hose at any particular time, and other factors. The following are considerations for electrically nonconductive and conductive Hose. For other applications consult the individual catalog pages and the appropriate industry or regulatory standards for proper selection.

2.1.1 Electrically Nonconductive Hose: Certain applications require that the Hose be nonconductive to prevent electrical current flow or to maintain electrical isolation. For applications that require Hose to be electrically nonconductive, including but not limited to applications near high voltage electric lines, only special nonconductive Hose can be used. The manufacturer of the equipment in which the nonconductive Hose is to be used must be consulted to be certain that the Hose, Tube and Fittings that are selected are proper for the application. Do not use any Parker Hose or Fittings for any such application requiring nonconductive Hose, including but not limited to applications near high voltage electric lines or dense magnetic fields, unless (i) the application is expressly approved in the Parker technical publication for the product, (ii) the Hose is marked "nonconductive", and (iii) the manufacturer of the equipment on which the Hose is to be used specifically approves the particular Parker Hose, Tube and Fittings for such use.

2.1.2 Electrically Conductive Hose: Parker manufactures special Hose for certain applications that require electrically conductive Hose. Parker manufactures special Hose for conveying paint in airless paint spraying applications. This Hose is labeled "Electrically Conductive Airless Paint Spray Hose" on its layline and packaging. This Hose must be properly connected to the appropriate Parker Fittings and properly grounded in order to dissipate dangerous static charge buildup, which occurs in all airless paint spraying applications. Do not use any other Hose for airless paint spraying, even if electrically conductive. Use of any other Hose or failure to properly connect the Hose can cause a fire or an explosion resulting in death, personal injury, and property damage. All hoses that convey fuels must be grounded. Parker manufactures a special Hose for certain compressed natural gas ("CNG")

applications where static electricity buildup may occur. Parker CNG Hose assemblies comply with the requirements of ANSI/IAS NGV 4.2; CSA 12.52, "Hoses for Natural Gas Vehicles and Dispensing Systems" (www.ansi.org). This Hose is labeled "Electrically Conductive for CNG Use" on its layline and packaging. This Hose must be properly connected to the appropriate Parker Fittings and properly grounded in order to dissipate dangerous static charge buildup, which occurs in, for example, high velocity CNG dispensing or transfer. Do not use any other Hose for CNG applications where static charge buildup may occur, even if electrically conductive. Use of other Hoses in CNG applications or failure to properly connect or ground this Hose can cause a fire or an explosion resulting in death, personal injury, and property damage. Care must also be taken to protect against CNG permeation through the Hose wall. See section 2.6, Permeation, for more information. Parker CNG Hose is intended for dispenser and vehicle use within the specified temperature range. Parker CNG Hose should not be used in confined spaces or unventilated areas or areas exceeding the specified temperature range. Final assemblies must be tested for leaks. CNG Hose Assemblies should be tested on a monthly basis for conductivity per ANSI/IAS NGV 4.2; CSA 12.52. Parker manufactures special Hose for aerospace in-flight applications. Aerospace in-flight applications employing Hose to transmit fuel, lubricating fluids and hydraulic fluids require a special Hose with a conductive inner tube. This Hose for in-flight applications is available only from Parker's Stratoflex Products Division. Do not use any other Parker Hose for in-flight applications, even if electrically conductive. Use of other Hoses for in-flight applications or failure to properly connect or ground this Hose can cause a fire or an explosion resulting in death, personal injury and property damage. These Hose assemblies for in-flight applications must meet all applicable aerospace industry, aircraft engine and aircraft requirements.

2.2 Pressure: Hose, Tube and Fitting selection must be made so that the published maximum working pressure of the Hose, Tube and Fittings are equal to or greater than the maximum system pressure. The maximum working pressure of a Hose, or Tube Assembly is the lower of the respective published maximum working pressures of the Hose, Tube and the Fittings used. Surge pressures or peak transient pressures in the system must be below the published maximum working pressure for the Hose, Tube and Fitting. Surge pressures and peak pressures can usually only be determined by sensitive electrical instrumentation that measures and indicates pressures at millisecond intervals. Mechanical pressure gauges indicate only average pressures and cannot be used to determine surge pressures or peak transient pressures. Published burst pressure ratings for Hose is for manufacturing test purposes only and is no indication that the Product can be used in applications at the burst pressure or otherwise above the published maximum recommended working pressure.

2.3 Suction: Hoses used for suction applications must be selected to insure that the Hose will withstand the vacuum and pressure of the system. Improperly selected Hose may collapse in suction application.

2.4 Temperature: Be certain that fluid and ambient temperatures, both steady and transient, do not exceed the limitations of the Hose, Tube, Fitting and Seals. Temperatures below and above the recommended limit can degrade Hose, Tube, Fittings and Seals to a point where a failure may occur and release fluid. Tube and Fittings performances are normally degraded at elevated temperature. Material compatibility can also change at temperatures outside of the rated range. Properly insulate and protect the Hose Assembly when routing near hot objects (e.g. manifolds). Do not use any Hose in any application where failure of the Hose could result in the conveyed fluids (or vapors or mist from the conveyed fluids) contacting any open flame, molten metal, or other potential fire ignition source that could cause burning or explosion of the conveyed fluids or vapors.

2.5 Fluid Compatibility: Hose, and Tube Assembly selection must assure compatibility of the Hose tube, cover, reinforcement, Tube, Plating and Seals with the fluid media used. See the fluid compatibility chart in the Parker publication for the product being considered or used. This information is offered only as a guide. Actual service life can only be determined by the end user by testing under all extreme conditions and other analysis. Hose, and Tube that is chemically compatible with a particular fluid must be assembled using Fittings and adapters containing likewise compatible seals. Flange or flare processes can change Tube material properties that may not be compatible with certain requirements such as NACE

2.6 Permeation: Permeation (that is, seepage through the Hose or Seal) will occur from inside the Hose or Fitting to outside when Hose or Fitting is used with gases, liquid and gas fuels, and refrigerants (including but not limited to such materials as helium, diesel fuel, gasoline,

natural gas, or LPG). This permeation may result in high concentrations of vapors which are potentially flammable, explosive, or toxic, and in loss of fluid. Dangerous explosions, fires, and other hazards can result when using the wrong Hose for such applications. The system designer must take into account the fact that this permeation will take place and must not use Hose or Fitting if this permeation could be hazardous. The system designer must take into account all legal, government, insurance, or any other special regulations which govern the use of fuels and refrigerants. Never use a Hose or Fitting even though the fluid compatibility is acceptable without considering the potential hazardous effects that can result from permeation through the Hose or Tube Assembly. Permeation of moisture from outside the Hose or Fitting to inside the Hose or Fitting will also occur in Hose or Tube assemblies, regardless of internal pressure. If this moisture permeation would have detrimental effects (particularly, but not limited to refrigeration and air conditioning systems), incorporation of sufficient drying capacity in the system or other appropriate system safeguards should be selected and used. The sudden pressure release of highly pressurized gas could also result in Explosive Decompression failure of permeated Seals and Hoses.

2.7 Size: Transmission of power by means of pressurized fluid varies with pressure and rate of flow. The size of the components must be adequate to keep pressure losses to a minimum and avoid damage due to heat generation or excessive fluid velocity.

2.8 Routing: Attention must be given to optimum routing to minimize inherent problems (kinking or flow restriction due to Hose collapse, twisting of the Hose, proximity to hot objects or heat sources). For additional routing recommendations see SAE J1273 and ISO 17165-2. Hose Assemblies have a finite life and should be installed in a manner that allows for ease of inspection and future replacement. Hose because of its relative short life, should not be used in residential and commercial buildings inside of inaccessible walls or floors, unless specifically allowed in the product literature. Always review all product literature for proper installation and routing instructions.

2.9 Environment: Care must be taken to insure that the Hose, Tube and Fittings are either compatible with or protected from the environment (that is, surrounding conditions) to which they are exposed. Environmental conditions including but not limited to ultraviolet radiation, sunlight, heat, ozone, moisture, water, salt water, chemicals and air pollutants can cause degradation and premature failure.

2.10 Mechanical Loads: External forces can significantly reduce Hose, Tube and Fitting life or cause failure. Mechanical loads which must be considered include excessive flexing, twist, kinking, tensile or side loads, bend radius, and vibration. Use of swivel type Fittings or adapters may be required to insure no twist is put into the Hose. Use of proper Hose or Tube clamps may also be required to reduce external mechanical loads. Unusual applications may require special testing prior to Hose selection.

2.11 Physical Damage: Care must be taken to protect Hose from wear, snagging, kinking, bending smaller than minimum bend radius and cutting, any of which can cause premature Hose failure. Any Hose that has been kinked or bent to a radius smaller than the minimum bend radius, and any Hose that has been cut or is cracked or is otherwise damaged should be removed and discarded. Fittings with damages such as scratches on sealing surfaces and deformation should be replaced.

2.12 Proper End Fitting: See instructions 3.2 through 3.5. These recommendations may be substantiated by testing to industry standards such as SAE J517 for hydraulic applications, or MIL-A-5070, AS1339, or AS3517 for Hoses from Parker's Stratoflex Products Division for aerospace applications.

2.13 Length: When determining the proper Hose or Tube length of an assembly, be aware of Hose length change due to pressure, Tube length change due to thermal expansion or contraction, and Hose or Tube and machine tolerances and movement must be considered. When routing short hose assemblies, it is recommended that the minimum free hose length is always used. Consult the hose manufacturer for their minimum free hose length recommendations. Hose assemblies should be installed in such a way that any motion or flexing occurs within the same plane.

2.14 Specifications and Standards: When selecting Hose, Tube and Fittings, government, industry, and Parker specifications and recommendations must be reviewed and followed as applicable.

2.15 Hose Cleanliness: Hose and Tube components may vary in cleanliness levels. Care must be taken to insure that the Hose and Tube Assembly selected has an adequate level of cleanliness for the application.

2.16 Fire Resistant Fluids: Some fire resistant fluids that are to be conveyed by Hose or Tube require use of the same type of Hose or Tube as used with petroleum base fluids. Some such fluids require a special Hose, Tube, Fitting and Seal, while a few fluids will not work with any Hose at all. See instructions 2.5 and 1.5. The wrong Hose, Tube, Fitting or Seal may fail after a very short service. In addition, all liquids but pure water may burn fiercely under certain conditions, and even pure water leakage may be hazardous.

2.17 Radiant Heat: Hose and Seals can be heated to destruction without contact by such nearby items as hot manifolds or molten metal. The same heat source may then initiate a fire. This can occur despite the presence of cool air around the Hose or Seal. Performance of Tube and Fitting subjected to the heat could be degraded.

2.18 Welding or Brazing: When using a torch or arc welder in close proximity to hydraulic lines, the hydraulic lines should be removed or shielded with appropriate fire resistant materials. Flame or weld spatter could burn through the Hose or Seal and possibly ignite escaping fluid resulting in a catastrophic failure. Heating of plated parts, including Hose Fittings and adapters, above 450°F (232°C) such as during welding, brazing or soldering may emit deadly gases. Any elastomer seal on fittings shall be removed prior to welding or brazing, any metallic surfaces shall be protected after brazing or welding when necessary. Welding and brazing filler material shall be compatible with the Tube and Fitting that are joined.

2.19 Atomic Radiation: Atomic radiation affects all materials used in Hose and Tube assemblies. Since the long-term effects may be unknown, do not expose Hose or Tube assemblies to atomic radiation. Nuclear applications may require special Tube and Fittings.

2.20 Aerospace Applications: The only Hose, Tube and Fittings that may be used for in-flight aerospace applications are those available from Parker's Stratoflex Products Division. Do not use any other Hose or Fittings for in-flight applications. Do not use any Hose or Fittings from Parker's Stratoflex Products Division with any other Hose or Fittings, unless expressly approved in writing by the engineering manager or chief engineer of Stratoflex Products Division and verified by the user's own testing and inspection to aerospace industry standards.

2.21 Unlocking Couplings: Ball locking couplings or other Fittings with quick disconnect ability can unintentionally disconnect if they are dragged over obstructions, or if the sleeve or other disconnect member, is bumped or moved enough to cause disconnect. Threaded Fittings should be considered where there is a potential for accidental uncoupling.

3.0 HOSE AND FITTINGS ASSEMBLY AND INSTALLATION INSTRUCTIONS

3.1 Component Inspection: Prior to assembly, a careful examination of the Hose and Fittings must be performed. All components must be checked for correct style, size, catalog number, and length. The Hose must be examined for cleanliness, obstructions, blisters, cover looseness, kinks, cracks, cuts or any other visible defects. Inspect the Fitting and sealing surfaces for burrs, nicks, corrosion or other imperfections. Do NOT use any component that displays any signs of nonconformance.

3.2 Hose and Fitting Assembly: Do not assemble a Parker Fitting on a Parker Hose that is not specifically listed by Parker for that Fitting, unless authorized in writing by the engineering manager or chief engineer of the appropriate Parker division. Do not assemble a Parker Fitting on another manufacturer's Hose or a Parker Hose on another manufacturer's Fitting unless (i) the engineering manager or chief engineer of the appropriate Parker division approves the Assembly in writing or that combination is expressly approved in the appropriate Parker literature for the specific Parker product, and

(ii) the user verifies the Assembly and the application through analysis and testing. For Parker Hose that does not specify a Parker Fitting, the user is solely responsible for the selection of the proper Fitting and Hose Assembly procedures. See instruction 1.4. To prevent the possibility of problems such as leakage at the Fitting or system contamination, it is important to completely remove all debris from the cutting operation before installation of the Fittings. The Parker published instructions must be followed for assembling the Fittings on the Hose. These instructions are provided in the Parker Fitting catalog for the specific Parker Fitting being used, or by calling 1-800-CPARKER, or at www.parker.com.

3.3 Related Accessories: Do not crimp or swage any Parker Hose or Fitting with anything but the listed swage or crimp machine and dies in accordance with Parker published instructions. Do not crimp

or swage another manufacturer's Fitting with a Parker crimp or swage die unless authorized in writing by the engineering manager or chief engineer of the appropriate Parker division.

3.4 Parts: Do not use any Parker Fitting part (including but not limited to socket, shell, nipple, or insert) except with the correct Parker mating parts, in accordance with Parker published instructions, unless authorized in writing by the engineering manager or chief engineer of the appropriate Parker division.

3.5 Field Attachable/Permanent: Do not reuse any field attachable Hose Fitting that has blown or pulled off a Hose. Do not reuse a Parker permanent Hose Fitting (crimped or swaged) or any part thereof. Complete Hose Assemblies may only be reused after proper inspection under section 4.0. Do not assemble Fittings to any previously used hydraulic Hose that was in service, for use in a fluid power application.

3.6 Pre-Installation Inspection: Prior to installation, a careful examination of the Hose Assembly must be performed. Inspect the Hose Assembly for any damage or defects. DO NOT use any Hose Assembly that displays any signs of nonconformance.

3.7 Minimum Bend Radius: Installation of a Hose at less than the minimum listed bend radius may significantly reduce the Hose life. Particular attention must be given to preclude sharp bending at the Hose to Fitting juncture. Any bending during installation at less than the minimum bend radius must be avoided. If any Hose is kinked during installation, the Hose must be discarded.

3.8 Twist Angle and Orientation: Hose Assembly installation must be such that relative motion of machine components does not produce twisting.

3.9 Securement: In many applications, it may be necessary to restrain, protect, or guide the Hose to protect it from damage by unnecessary flexing, pressure surges, and contact with other mechanical components. Care must be taken to insure such restraints do not introduce additional stress or wear points.

3.10 Proper Connection of Ports: Proper physical installation of the Hose Assembly requires a correctly installed port connection insuring that no twist or torque is transferred to the Hose when the Fittings are being tightened or otherwise during use.

3.11 External Damage: Proper installation is not complete without insuring that tensile loads, side loads, kinking, flattening, potential abrasion, thread damage or damage to sealing surfaces are corrected or eliminated. See instruction 2.10.

3.12 System Checkout: All air entrapment must be eliminated and the system pressurized to the maximum system pressure (at or below the Hose maximum working pressure) and checked for proper function and freedom from leaks. Personnel must stay out of potential hazardous areas while testing and using.

3.13 Routing: The Hose Assembly should be routed in such a manner so if a failure does occur, the escaping media will not cause personal injury or property damage. In addition, if fluid media comes in contact with hot surfaces, open flame or sparks, a fire or explosion may occur. See section 2.4.

3.14 Ground Fault Equipment Protection Devices (GFEPDs): WARNING! Fire and Shock Hazard. To minimize the danger of fire if the heating cable of a Multitube bundle is damaged or improperly installed, use a Ground Fault Equipment Protection Device. Electrical fault currents may be insufficient to trip a conventional circuit breaker. For ground fault protection, the IEEE 515: (www.ansi.org) standard for heating cables recommends the use of GFEPDs with a nominal 30 milliampere trip level for "piping systems in classified areas, those areas requiring a high degree of maintenance, or which may be exposed to physical abuse or corrosive atmospheres".

4.0 TUBE AND FITTINGS ASSEMBLY AND INSTALLATION INSTRUCTIONS

4.1 Component Inspection: Prior to assembly, a careful examination of the Tube and Fittings must be performed. All components must be checked for correct style, size, material, seal, and length. Inspect the Fitting and sealing surfaces for burrs, nicks, corrosion, missing seal or other imperfections. Do NOT use any component that displays any signs of nonconformance.

4.2 Tube and Fitting Assembly: Do not assemble a Parker Fitting with a Tube that is not specifically listed by Parker for that Fitting, unless authorized in writing by the engineering manager or chief engineer of the appropriate Parker division. The Tube must meet the requirements specified to the Fitting. The Parker published instructions must be followed for assembling the Fittings to a Tube. These instructions

are provided in the Parker Fitting catalog for the specific Parker Fitting being used, or by calling 1-800-CPARKER, or at www.parker.com.

4.3 Related Accessories: Do not preset or flange Parker Fitting components using another manufacturer's equipment or procedures unless authorized in writing by the engineering manager or chief engineer of the appropriate Parker division. Tube, Fitting component and tooling must be checked for correct style, size and material. Operation and maintenance of Related Accessories must be in accordance with the operation manual for the designated Accessory.

4.4 Securement: In many applications, it may be necessary to restrain, protect, or guide the Tube to protect it from damage by unnecessary flexing, pressure surges, vibration, and contact with other mechanical components. Care must be taken to insure such restraints do not introduce additional stress or wear points.

4.5 Proper Connection of Ports: Proper physical installation of the Tube Assembly requires a correctly installed port connection insuring that no torque is transferred to the Tube when the Fittings are being tightened or otherwise during use.

4.6 External Damage: Proper installation is not complete without insuring that tensile loads, side loads, flattening, potential abrasion, thread damage or damage to sealing surfaces are corrected or eliminated. See instruction 2.10.

4.7 System Checkout: All air entrapment must be eliminated and the system pressurized to the maximum system pressure (at or below the Tube Assembly maximum working pressure) and checked for proper function and freedom from leaks. Personnel must stay out of potential hazardous areas while testing and using.

Routing: The Tube Assembly should be routed in such a manner so if a failure does occur, the escaping media will not cause personal injury or property damage. In addition, if fluid media comes in contact with hot surfaces, open flame or sparks, a fire or explosion may occur. See section 2.4.

5.0 HOSE AND FITTING MAINTENANCE AND REPLACEMENT INSTRUCTIONS

5.1 Even with proper selection and installation, Hose life may be significantly reduced without a continuing maintenance program. The severity of the application, risk potential from a possible Hose failure, and experience with any Hose failures in the application or in similar applications should determine the frequency of the inspection and the replacement for the Products so that Products are replaced before any failure occurs. Certain products require maintenance and inspection per industry requirements. Failure to adhere to these requirements may lead to premature failure. A maintenance program must be established and followed by the user and, at minimum, must include instructions 5.2 through 5.7

5.2 Visual Inspection Hose/Fitting: Any of the following conditions require immediate shut down and replacement of the Hose Assembly:

- Fitting slippage on Hose;
- Damaged, cracked, cut or abraded cover (any reinforcement exposed);
- Hard, stiff, heat cracked, or charred Hose;
- Cracked, damaged, or badly corroded Fittings;
- Leaks at Fitting or in Hose;
- Kinked, crushed, flattened or twisted Hose; and
- Blistered, soft, degraded, or loose cover.

5.3 Visual Inspection All Other: The following items must be tightened, repaired, corrected or replaced as required:

- Leaking port conditions;
- Excess dirt buildup;
- Worn clamps, guards or shields; and
- System fluid level, fluid type, and any air entrapment.

5.4 Functional Test: Operate the system at maximum operating pressure and check for possible malfunctions and leaks. Personnel must avoid potential hazardous areas while testing and using the system. See section 2.2.

5.5 Replacement Intervals: Hose assemblies and elastomeric seals used on Hose Fittings and adapters will eventually age, harden, wear and deteriorate under thermal cycling and compression set. Hose Assemblies and elastomeric seals should be inspected and replaced at specific replacement intervals, based on previous service life, government or industry recommendations, or when failures could result in unacceptable downtime, damage, or injury risk. See section 1.2. Hose and Fittings may be subjected to internal mechanical and/or chemical wear from the conveying fluid and may fail without warning. The user must determine the product life under such circumstances by testing. Also see section 2.5.

5.6 Hose Inspection and Failure: Hydraulic power is accomplished by utilizing high pressure fluids to transfer energy and do work. Hoses, Fittings and Hose Assemblies all contribute to this by transmitting fluids at high pressures. Fluids under pressure can be dangerous and potentially lethal and, therefore, extreme caution must be exercised when working with fluids under pressure and handling the Hoses transporting the fluids. From time to time, Hose Assemblies will fail if they are not replaced at proper time intervals. Usually these failures are the result of some form of misapplication, abuse, wear or failure to perform proper maintenance. When Hoses fail, generally the high pressure fluids inside escape in a stream which may or may not be visible to the user. Under no circumstances should the user attempt to locate the leak by "feeling" with their hands or any other part of their body. High pressure fluids can and will penetrate the skin and cause severe tissue damage and possibly loss of limb. Even seemingly minor hydraulic fluid injection injuries must be treated immediately by a physician with knowledge of the tissue damaging properties of hydraulic fluid.

If a Hose failure occurs, immediately shut down the equipment and leave the area until pressure has been completely released from the Hose Assembly. Simply shutting down the hydraulic pump may or may not eliminate the pressure in the Hose Assembly. Many times check valves, etc., are employed in a system and can cause pressure to remain in a Hose Assembly even when pumps or equipment are not operating. Tiny holes in the Hose, commonly known as pinholes, can eject small, dangerously powerful but hard to see streams of hydraulic fluid. It may take several minutes or even hours for the pressure to be relieved so that the Hose Assembly may be examined safely. Once the pressure has been reduced to zero, the Hose Assembly may be taken off the equipment and examined. It must always be replaced if a failure has occurred. Never attempt to patch or repair a Hose Assembly that has failed. Consult the nearest Parker distributor or the appropriate Parker division for Hose Assembly replacement information. Never touch or examine a failed Hose Assembly unless it is obvious that the Hose no longer contains fluid under pressure. The high pressure fluid is extremely dangerous and can cause serious and potentially fatal injury.

5.7 Elastomeric seals: Elastomeric seals will eventually age, harden, wear and deteriorate under thermal cycling and compression set. Elastomeric seals should be inspected and replaced.

5.8 Refrigerant gases: Special care should be taken when working with refrigeration systems. Sudden escape of refrigerant gases can cause blindness if the escaping gases contact the eye and can cause freezing or other severe injuries if it contacts any other portion of the body.

5.9 Compressed natural gas (CNG): Parker CNG Hose Assemblies should be tested after installation and before use, and at least on a monthly basis per instructions provided on the Hose Assembly tag. The recommended procedure is to pressurize the Hose and check for leaks and to visually inspect the Hose for damage and to perform an electrical resistance test.

Caution: Matches, candles, open flame or other sources of ignition shall not be used for Hose inspection. Leak check solutions should be rinsed off after use.

6.0 HOSE STORAGE

6.1 Age Control: Hose and Hose Assemblies must be stored in a manner that facilitates age control and first-in and first-out usage based on manufacturing date of the Hose and Hose Assemblies. Unless otherwise specified by the manufacturer or defined by local laws and regulations:

6.1.1 The shelf life of rubber hose in bulk form or hose made from two or more materials is 28 quarters (7 years) from the date of manufacture, with an extension of 12 quarters (3 years), if stored in accordance with ISO 2230;

6.1.2 The shelf life of thermoplastic and polytetrafluoroethylene hose is considered to be unlimited;

6.1.3 Hose assemblies that pass visual inspection and proof test shall not be stored for longer than 2 years.

6.1.4 Storage: Stored Hose and Hose Assemblies must not be subjected to damage that could reduce their expected service life and must be placed in a cool, dark and dry area with the ends capped. Stored Hose and Hose Assemblies must not be exposed to temperature extremes, ozone, oils, corrosive liquids or fumes, solvents, high humidity, rodents, insects, ultraviolet light, electromagnetic fields or radioactive materials.

Technical data

Technical data	
Hose overview	Ab-2 – Ab-4
Hose fittings overview	Ab-5 – Ab-8
Hose fittings pressure ratings	Ab-9 – Ab-11
Hose fittings nomenclature	Ab-12 – Ab-15
Classification bodies	Ab-16
Approvals for Parker hydraulic hoses	Ab-17 – Ab-19
Conversion chart	Ab-20
Temperature and pressure chart	Ab-21
Flow capacity nomogram	Ab-22
The correct method to fit female swivel ends	Ab-23
The correct method to fit ISO 6162-1 and ISO 6162-2 flanges	Ab-24 – Ab-25
Chemical resistance table	Ab-26 – Ab-34

Hose overview	Hose	Fitting serie	Working Pressure (MPa) at size / DN																Temp. °C	Construction	Standard	
			-3	-4	-5	-6	-8	-10	-12	-16	-20	-24	-32	-40	-48	-56	-64	-80				-96
Low pressure	801Plus	82	5	6	8	10	12	16	19	25	31	38	51	63	76	90	100	125	150	-40/+100	1 braid, fibre	
	830M	82	2.4	1.6	1.6	2.4	2.1	2.1	2.1	1.4										-40/+80	1 braid, fibre	
	837BM	82	1.6	1.6	1.6	1.6	1.6	1.6	1.6	1.6										-40/+100	1 braid, fibre	
	837PU	82	1.6	1.6	1.6	1.6	1.6	1.6	1.6	1.6										-40/+100	1 braid, fibre	
	801RH	82	2.4			2.4														-40/+100	1 braid, fibre	
	804	82	1.0			1.0	1.0	1.0	1.0											-40/+80	1 braid, fibre	
	821FR	82	2.4			2.1	2.1		1.7											-40/+100	1 braid, fibre	
	836	82	2.8			2.8	2.8	2.4	2.1											-48/+150	1 braid, fibre	
	846	82	1.6			1.6	1.6	1.6	1.6											-48/+150	1 braid, fibre	
	838M	82	1.6			1.6	1.6	1.6	1.6											-40/+80	1 braid, fibre	
Push-Lok	681	47	7.5	6.8	6.3	5.8	5.0	4.5	4.0										-40/+100	1 braid, fibre	EN 854-2TE	
	611HT	47	2.8	2.8	2.8	2.8	2.4	2.1	2.0										-40/+150	1 braid, fibre	EN 854-R6	
	681DB	47	7.5	6.8	6.3	5.8	5.0	4.5	4.0										-40/+100	1 braid, fibre	EN 854-2TE	
	201	26	20.7	20.7	15.5	13.8	12.0	10.3	5.5	4.3	3.5	2.4							-40/+150	1 braid, fibre	SAE 100R5 - SAE J1402 All	
	206	26	20.7	20.7	15.5	13.8	12.0	10.3	5.5	4.3	3.5	2.4							-48/+150	1 braid, fibre	SAE 100R5 - SAE J1402 All	
	213	26	13.8	10.3	10.3	8.6	6.9	5.2	2.8	2.1	1.7	1.4							-45/+150	1 braid, fibre	SAE J1402 AI	
	293	26	3.5			3.5	3.5	3.1	3.1	3.1									-50/+150	1 braid, fibre	SAE J1402 AI	
	221FR	26			3.5	3.5	3.5	3.5	3.5	3.5									-20/+100	1 braid, wire	SAE J1527 R3	
	285	26	3.4			3.4	3.4	3.4	3.4	3.4	3.5	2.4							-30/+125	1 braid, fibre	SAE J2064 C	
	244	26																	-30/+125	1 braid, wire	SAE J2064 B Class I	
Transport + Hydraulic																						

in parentheses “()”: The fitting series depends on the hose ID (size). For details, please refer to the respective hose page in this catalogue

Hose overview High pressure	Hose	Fitting serie	Working Pressure (MPa) at size / DN																	Temp. °C	Construction	Standard		
			-3	-4	-5	-6	-8	-10	-12	-16	-20	-24	-32	-40	-48	-56	-64	-80	-96				150	
			5	6	8	10	12	16	19	25	31	38	51	63	76	90	100	125	150					
GlobalCore	722	43					28.0	28.0	28.0	28.0	28.0	28.0	28.0									-40/+100	4 spiral, wire	Exceeds ISO 18752-BC
	722TC	43					28.0	28.0	28.0	28.0	28.0	28.0	28.0									-40/+125	4 spiral, wire	Exceeds ISO 18752-CC
	722ST	43					28.0	28.0	28.0	28.0	28.0	28.0	28.0									-40/+125	4 spiral, wire	Exceeds ISO 18752-CC
	787	(43, 48, 77)					35.0	35.0	35.0	35.0	35.0	35.0	35.0	35.0	35.0	35.0	35.0	35.0	35.0	35.0	35.0	-40/+100	4/6 spiral, wire ¹	Exceeds ISO 18752-BC
	787TC	(43, 48, 77)					35.0	35.0	35.0	35.0	35.0	35.0	35.0	35.0	35.0	35.0	35.0	35.0	35.0	35.0	35.0	-40/+125	4/6 spiral, wire ¹	Exceeds ISO 18752-DC
	787ST	(43, 48, 77)					35.0	35.0	35.0	35.0	35.0	35.0	35.0	35.0	35.0	35.0	35.0	35.0	35.0	35.0	35.0	-40/+125	4/6 spiral, wire ¹	Exceeds ISO 18752-DC
	797	(43, 48, 77)					42.0	42.0	42.0	42.0	42.0	42.0	42.0	42.0	42.0	42.0	42.0	42.0	42.0	42.0	42.0	-40/+100	4/6 spiral, wire ¹	Exceeds ISO 18752-BC
Standard	797TC	(43, 48, 77)					42.0	42.0	42.0	42.0	42.0	42.0	42.0	42.0	42.0	42.0	42.0	42.0	42.0	42.0	42.0	-40/+125	4/6 spiral, wire ¹	Exceeds ISO 18752-DC - ISO 18752-CC ²
	797ST	(43, 48, 77)					42.0	42.0	42.0	42.0	42.0	42.0	42.0	42.0	42.0	42.0	42.0	42.0	42.0	42.0	42.0	-40/+125	4/6 spiral, wire ¹	Exceeds ISO 18752-DC - ISO 18752-CC ²
	372	70					44.5	41.5	35.0	35.0	28.0											-40/+100	3 braids, wire	
	371LT	70					44.5	41.5	35.0	35.0	28.0											-50/+100	3 braids, wire	
	372TC	70					44.5	41.5	35.0	35.0	28.0											-40/+100	3 braids, wire	
	372RH	70					44.5	41.5	35.0	35.0	28.0											-40/+100	3 braids, wire	
	SX35	73									35.0	35.0	35.0									-40/+125	4 spiral, wire	ISO 3862 Typ R13
Low temperature	SX42	(73, 77)								42.0	42.0	42.0										-40/+125	4/6 spiral, wire ¹	ISO 3862 Typ R15
	701	70					45.0	41.5	35.0	35.0	28.0											-40/+100	4 spiral, wire	Exceeds EN 856-4SP - ISO 3862-4SP
	731	73								42.0	38.0	32.0	29.0	25.0								-40/+100	4 spiral, wire	Exceeds EN 856-4SH - ISO 3862-4SH
	SX35LT	73								35.0	35.0	35.0										-57/+100	4 spiral, wire	
	SX42LT	(73, 77)								42.0	42.0	42.0										-57/+100	4/6 spiral, wire ¹	
	774	⊕								28.0	28.0	21.0	17.5	17.5								-40/+80	4 spiral, wire	ISO 3862-R15 - SAE 100R15
	F42	(70)								42.0	42.0	42.0										-40/+80	4/6 spiral, wire ¹	ISO 3862 Typ R13
Phosphat-Ester	SX35TC	73								35.0	35.0	35.0										-40/+125	4 spiral, wire	ISO 3862 Typ R15
	SX42TC	(73, 77)								42.0	42.0	42.0										-40/+125	4/6 spiral, wire ¹	EN 856-4SP - ISO 3862-4SP
	701TC	70					45.0	41.5	35.0	35.0	28.0											-40/+100	4 spiral, wire	EN 856-4SP - ISO 3862-4SP
	731TC	73								42.0	38.0	32.0	29.0	25.0								-40/+125	4 spiral, wire	ISO 3862-4SH - EN 856-4SH
	797RH	77								42.0	42.0	42.0	42.0									-40/+125	4/6 spiral, wire ¹	Exceeds SAE 100R15 - ISO 3862 R15 - ISO 18752-DC/CC
	H31	(V5, V4)					50.0			44.5	41.5	39.0	35.0	31.0								-40/+100	4 spiral, wire	Exceeds EN 856-4SP - ISO 3862-4SP
	H29	V4								43.0	40.0	35.0	31.0	28.0								-40/+100	4 spiral, wire	Exceeds EN 856-4SH - ISO 3862-4SH
High abrasion resistance	R35	(V4, V6)								35.0	35.0	35.0	35.0	35.0								-40/+125	4/6 spiral, wire ¹	EN 856-R13 - ISO 3862-R13 - SAE 100R13
	R42	(V4, V6)								42.0	42.0	42.0	42.0	42.0								-40/+125	4/6 spiral, wire ¹	ISO 3862-R15 - SAE 100R15
	H31TC	(V5, V4)					50.0			44.5	41.5	39.0	35.0	31.0								-40/+100	4 spiral, wire	Exceeds EN 856-4SP - ISO 3862-4SP
	H29TC	V4								43.0	40.0	35.0	31.0	28.0								-40/+100	4 spiral, wire	Exceeds EN 856-4SH - ISO 3862-4SH
	R35TC	(V4, V6)								35.0	35.0	35.0	35.0	35.0	35.0							-40/+125	4/6 spiral, wire ¹	EN 856-R13 - ISO 3862-R13 - SAE 100R13
	RD35TC	V6													35.0	35.0	35.0					-20/+100	6 spiral, wire	Exceeds ISO 3862 Typ R13
	RS35TC	V6													35.0	35.0	35.0					-40/+125	6 spiral, wire	ISO 6907-D
Extreme abrasion resistance	R42TC	(V4, V6)								42.0	42.0	42.0	42.0	42.0								-40/+125	4/6 spiral, wire ¹	ISO 3862-R15 - SAE 100R15
	R50TC	(V4, V6)								50.0	50.0	50.0	50.0	50.0								-40/+100	4/6 spiral, wire ¹	Exceeds ISO 3862-R15
	R56TC	V5					56.0			56.0	56.0											-40/+100	4 spiral, wire	Exceeds ISO 3862-R15
	H31ST	(V5, V4)					50.0			44.5	41.5	39.0	35.0	31.0								-40/+100	4 spiral, wire	Exceeds EN 856-4SP - ISO 3862-4SP
	H29ST	V4								43.0	40.0	35.0	31.0	28.0								-40/+100	4 spiral, wire	Exceeds EN 856-4SH - ISO 3862-4SH
	R42ST	(V4, V6)								42.0	42.0	42.0	42.0	42.0	42.0							-40/+125	4/6 spiral, wire ¹	ISO 3862-R15 - SAE 100R15
	BPK	WB								110.0	110.0												@	4/6 spiral, wire ¹
Water-Blasting Firearmor BOP	FA35	(V4, V6, V5)								35.0	35.0	35.0	35.0	35.0								-40/+100	4/6 spiral, wire ¹	API 7K FSL0 - ISO 14693
	CEM69TC	V6																				-20/+100	6 spiral, wire	





⊕: on request; in parentheses "()": The fitting series depends on the hose ID (size).
 1: The hose construction depends on the hose ID (size). 2: The standard depends on the hose ID (size).
 3: Max. temperature +125 / +100 °C depends on the hose ID (size).
 For details, please refer to the respective hose page in this catalogue.
 * 35 MPa: Static applications according to ISO 6807-D @ Continuous service temperature range -10 °C up to +70 °C
 * 21 MPa: Dynamic hydraulic application design factor > 4:1 Max. service temperature range -40 °C up to +93 °C

Fittings overview



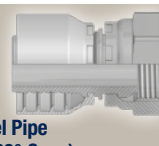

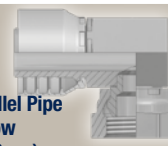
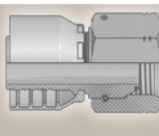
DIN – Metric

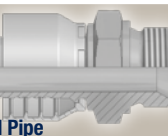
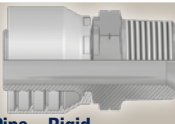
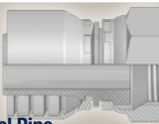
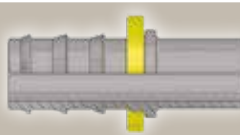
<p>CA</p>  <p>Female Metric 24° Light Series with O-Ring Swivel – Straight ISO 12151-2-SWS-L – DKOL</p>	<p>CE</p>  <p>Female Metric 24° Light Series with O-Ring Swivel – 45° Elbow ISO 12151-2-SWE-L – DKOL 45°</p>	<p>CF</p>  <p>Female Metric 24° Light Series with O-Ring Swivel – 90° Elbow ISO 12151-2-SWE-L – DKOL 90°</p>	<p>D0</p>  <p>Male Metric 24° Light Series – Rigid Straight ISO 12151-2-S-L – CEL</p>
<p>C3</p>  <p>Female Metric Light Series – Swivel Straight (Ball Nose for 24° or 60° Cone) DKL</p>	<p>C4</p>  <p>Female Metric Light Series – Swivel 45° Elbow (Ball Nose for 24° or 60° Cone) DKL 45°</p>	<p>C5</p>  <p>Female Metric Light Series – Swivel 90° Elbow (Ball Nose for 24° or 60° Cone) DKL 90°</p>	<p>C9</p>  <p>Female Metric 24° – Swivel Heavy Series with O-Ring Straight ISO 12151-2-SWS-S – DKOS</p>
<p>0C</p>  <p>Female Metric 24° – Swivel Heavy Series with O-Ring 45° Elbow ISO 12151-2 – SWE-S – DKOS 45°</p>	<p>1C</p>  <p>Female Metric 24° – Swivel Heavy Series with O-Ring 90° Elbow ISO 12151-2-SWE-S – DKOS 90°</p>	<p>D2</p>  <p>Male Metric 24° – Rigid Heavy Series – Straight ISO 12151-2-S-S – CES</p>	<p>49</p>  <p>Metric Banjo Straight DIN 7642</p>
<p>9B</p>  <p>Female Metric Swivel Light Series 45° Elbow (Ball Nose for 24° or 60° Cone)</p>	<p>9C</p>  <p>Female Metric Swivel Light Series 90° Elbow (Ball Nose for 24° or 60° Cone)</p>		



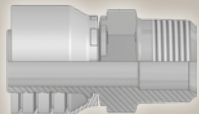

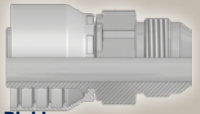
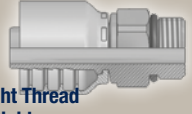
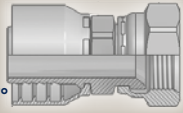
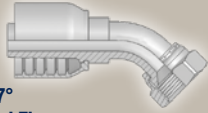
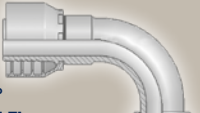

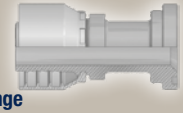
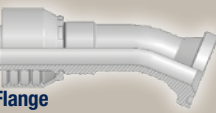
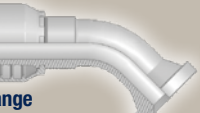

BSP

<p>92</p>  <p>Female BSP Parallel Pipe Swivel – Straight (60° Cone) BS5200-A – DKR</p>	<p>B1</p>  <p>Female BSP Parallel Pipe Swivel 45° Elbow (60° Cone) BS 5200-D – DKR 45°</p>	<p>B2</p>  <p>Female BSP Parallel Pipe Swivel 90° Elbow (60° Cone) BS 5200-B – DKR 90°</p>	<p>B4</p>  <p>Female BSP Parallel Pipe Swivel – 90° Elbow Block Type (60° Cone) BS 5200-E – DKR 90°</p>
<p>EA</p>  <p>BSP Swivel Female with O-Ring (60° Cone) BS 5200 – ISO 12151-6 – DKOR</p>	<p>EB</p>  <p>BSP Swivel Female with O-Ring 45° Elbow (60° Cone) BS 5200 – ISO 12151-6 – DKOR 45°</p>	<p>EC</p>  <p>BSP Swivel Female with O-Ring 90° Elbow (60° Cone) BS 5200 – ISO 12151-6 – DKOR 90°</p>	<p>D9</p>  <p>Male BSP Parallel Pipe Rigid – Straight (60° Cone) BS5200 – AGR</p>
<p>91</p>  <p>Male BSP Taper Pipe – Rigid Straight BS5200 – AGR-K</p>	<p>B5</p>  <p>Female BSP Parallel Pipe Swivel Straight (Flat Seat)</p>	<p>34</p>  <p>Inch Standpipe (Brass)</p>	

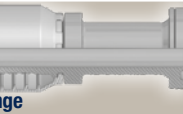
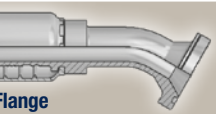

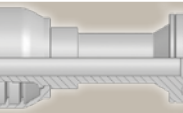
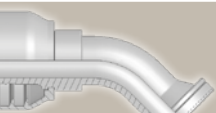
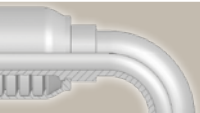
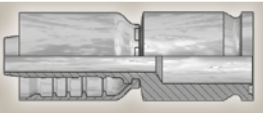
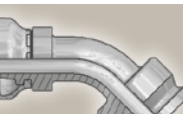
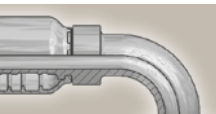
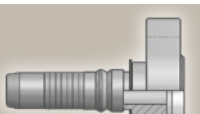
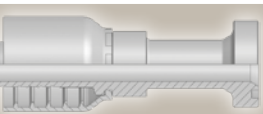

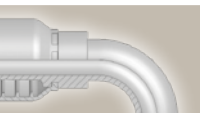
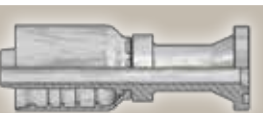
SAE

<p>01</p>  <p>Male NPTF Pipe Rigid - Straight SAE J476A / J516 - AGN</p>	<p>02</p>  <p>Female NPTF Pipe - Rigid Straight SAE J476A / J516</p>	<p>03</p>  <p>Male JIC 37° - Rigid Straight ISO 12151-5-S - AGJ</p>	<p>05</p>  <p>Male SAE Straight Thread with O-Ring - Rigid Straight ISO 11926 - SAE J516</p>
<p>06/68</p>  <p>Female - JIC 37° SAE 45° Dual Flare Swivel - Straight ISO 12151-5-SWS - DKJ</p>	<p>37/3V</p>  <p>Female JIC 37° SAE 45° - Dual Flare Swivel Female 45° Elbow ISO 12151-5-SWE 45° - DKJ 45°</p>	<p>39/3W</p>  <p>Female JIC 37° SAE 45° - Dual Flare Swivel Female 90° Elbow ISO 12151-5-SWES - DKJ 90°</p>	<p>41/3Y</p>  <p>Female JIC 37° / 45° Swivel Female 90° Elbow (Long) ISO 12151-5-SWEL - DKJ 90°L</p>

Flange

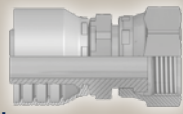
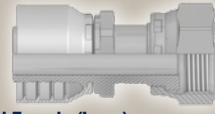
<p>15/4A</p>  <p>ISO 6162-1-Flange Straight ISO 12151-3-S-L - SFL (35.0 MPa/ 5000 psi)</p>	<p>16</p>  <p>ISO 6162-1 Flange 22.5° Elbow ISO 12151-3-E22ML - SFL 22.5° (21.0 MPa/ 3000 psi)</p>	<p>17/4F</p>  <p>ISO 6162-1-Flange 45° Elbow ISO 12151-3 - E45S - L - SFL 45° (21.0 MPa/ 3000 psi)</p>	<p>19/4N</p>  <p>ISO 6162-1-Flange 90° Elbow ISO 12151-3-E-L - SFL 90° (35.0 MPa/ 5000 psi)</p>
<p>6A</p>  <p>ISO 6162-2-Flange Straight ISO 12151-3-S-S - SFS (42.0 MPa/ 6000 psi)</p>	<p>6E</p>  <p>ISO 6162-2 Flange 30° Elbow SFS 30° (42.0 MPa/ 6000 psi)</p>	<p>6F</p>  <p>ISO 6162-2-Flange 45° Elbow - Heavy Series ISO 12151-3 - E45-S - SFS 45° (42.0 MPa/ 6000 psi)</p>	<p>6N</p>  <p>ISO 6162-2-Flange 90° Elbow ISO 12151-3 - E-S - SFS 90° (42.0 MPa/ 6000 psi)</p>
<p>8A</p>  <p>Flange - Straight 8000 psi</p>	<p>8F</p>  <p>Flange - 45° Elbow 8000 psi</p>	<p>8N</p>  <p>Flange - 90° Elbow 8000 psi</p>	<p>X5</p>  <p>Flange - Straight Full flange system for ISO 6162-1 or ISO 6162-2</p>
<p>X7</p>  <p>Flange - 45° Elbow Full flange system for ISO 6162-1 or ISO 6162-2</p>	<p>X9</p>  <p>Flange - 90° Elbow Full flange system for ISO 6162-1 or ISO 6162-2</p>	<p>PY</p>  <p>Flange - 24° Male French Gas Straight</p>	<p>XA</p>  <p>Caterpillar® Flange Straight</p>
<p>XF</p>  <p>Caterpillar® Flange 45° Elbow</p>	<p>XG</p>  <p>Caterpillar® Flange 60° Elbow</p>	<p>XN</p>  <p>Caterpillar® Flange 90° Elbow</p>	<p>K5</p>  <p>Komatsu® Flange Straight</p>
<p>K7</p>  <p>Komatsu® Flange 45° Elbow</p>	<p>K9</p>  <p>Komatsu® Flange 90° Elbow</p>		

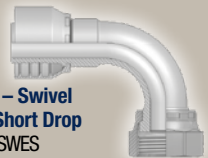
ORFS

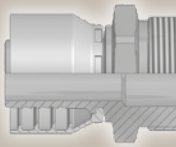
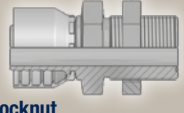
<p>JC</p>  <p>Female ORFS Swivel - Straight Short ISO 12151-1 - SWSA SAE J516 - ORFS</p>	<p>JS</p>  <p>ORFS Swivel Female (Long) ISO 12151-1-SWSB SAE J516 - ORFS</p>	<p>J7</p>  <p>Female ORFS - Swivel 45° Elbow ISO 12151-1 - SWE 45° SAE J516 - ORFS 45°</p>	<p>J9</p>  <p>Female ORFS - Swivel 90° Elbow - Short Drop ISO 12151-1 - SWES SAE J516 - ORFS 90°</p>
<p>J1</p>  <p>Female ORFS - Swivel 90° Elbow - Long Drop ISO 12151-1 - SWEL SAE J516 - ORFS 90° L</p>	<p>J5</p>  <p>Female ORFS - Swivel 90° Elbow - Medium Drop ISO 12151-1 - SWEM - ORFS 90° M</p>	<p>JM</p>  <p>ORFS Male ISO 12151-1-S - SAE J516</p>	<p>JD</p>  <p>Male ORFS Bulkhead with Locknut Straight (with O-ring) ISO 12151-1 - SAE J516</p>

JIS

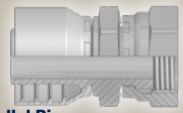
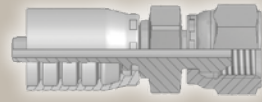
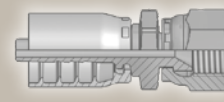
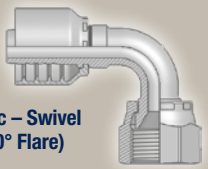
<p>FU</p>  <p>Female BSP Parallel Pipe Swivel - Straight (30° Flare) ISO 228-1 - JIS B8363 - GUI</p>	<p>GU</p>  <p>Female BSP Parallel Pipe Swivel - Straight (60° Cone) ISO 228-1 - JIS B8363 - GUO</p>	<p>MU</p>  <p>Female Metric - Swivel Straight (30° Flare) JIS B8363 - MU</p>	<p>MZ</p>  <p>Female Metric - Swivel 90° Elbow (30° Flare) JIS B8363</p>
---	--	--	--

High Pressure Cleaning

<p>CW</p>  <p>Power Cleaner Connection</p>	<p>NW</p>  <p>Female Kärcher Metric Cleaning Hose Fitting Swivel - Straight</p>	<p>PW</p>  <p>Male Kärcher Metric Cleaning Hose Fitting Rigid - Straight</p>
---	--	--

Others

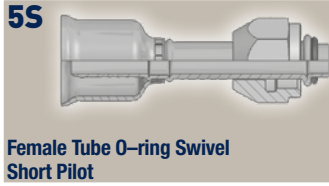
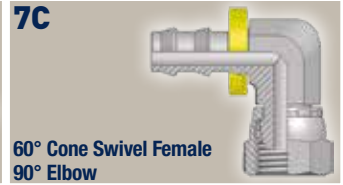
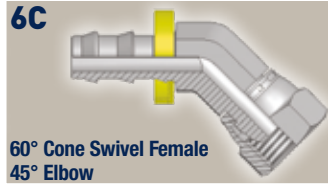
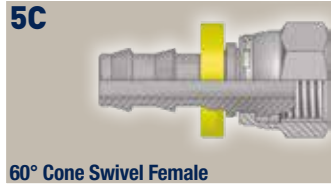
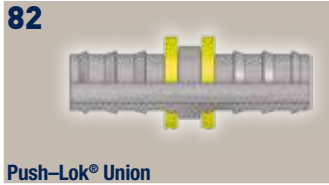
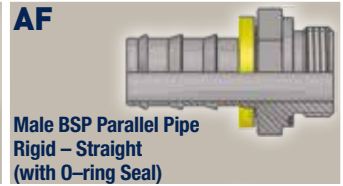
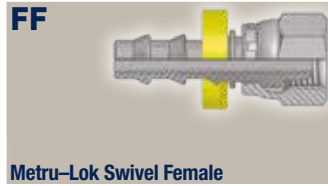
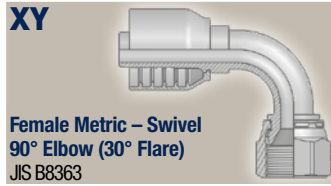
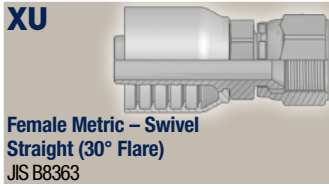

UPTC

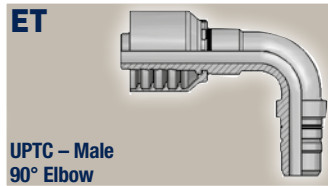
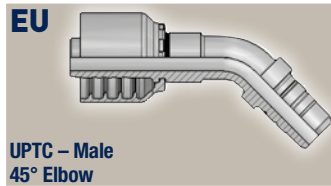
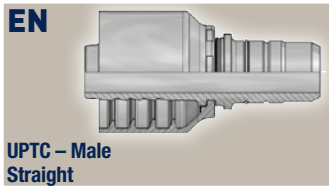

Hose fittings pressure ratings

* static working pressure
** dynamic working pressure

Fitting end connection	Description	Inch fittings (size) Maximum working pressure (MPa) – design factor 4:1														
		-4	-5	-6	-8	-10	-12	-16	-20	-24	-32	-40	-48	-56	-64	-80
92, B1, B2	BSP swivel female	63.0		55.0	43.0	42.0	42.0	42.0	35.0	30.0	25.0					
B5	BSP swivel female flat seat	63.0		55.0	43.0	37.5	35.0	28.0	25.0	21.0	21.0					
B4	BSP swivel female (compact brazed)	35.0	35.0	35.0	35.0	35.0	35.0	28.0	25.0	21.0	21.0					
EA, EB, EC	BSP swivel female with O-ring	45.0		45.0	42.0	42.0	42.0	42.0	35.0	30.0	25.0					
91, D9	BSP male	63.0		55.0	43.0		35.0	28.0	25.0	21.0	21.0					
01	NPTF male	83.0		69.0	69.0		52.0	45.0	35.0	21.0	17.5	35.0	35.0*			
02	NPTF female	48.0		41.0	35.0		28.0	21.0	17.5	14.0	14.0					
03, 33	SAE (JIC) 37° male	41.0	41.0	35.0	35.0	35.0	35.0	28.0	21.0	17.5	17.5					
04	SAE 45° male	41.0	41.0	35.0	35.0	35.0	35.0	28.0	21.0	17.5	17.5					
05	SAE male with O-ring	41.0	41.0	35.0	35.0	35.0	35.0	28.0	21.0	17.5	17.5					
06/68,37/3V, 39/3W, 41/3Y	SAE (JIC) 37° swivel female	41.0	41.0	35.0	35.0	35.0	35.0	28.0	21.0	17.5	17.5					
07	Female NPSM-pipe swivel	48.0		41.0	35.0		28.0	21.0								
08, 77, 79	Female SAE 45° swivel	21.0	21.0	21.0	21.0	19.0	15.5	14.0	11.0	9.0	8.0					
1L	Male NPTF pipe swivel 90° Elbow	21.0	21.0	21.0	21.0	19.0	15.5	14.0	11.0	9.0	8.0					
S2	Female NPTF pipe swivel	21.0	21.0	21.0	21.0	19.0	15.5	14.0	11.0	9.0	8.0					
0G, 0L	Male SAE O-ring	21.0	21.0	21.0	21.0	19.0	15.5	14.0	11.0	9.0	8.0					
28, 67, 69	SAE Male inverted 45° swivel	19.0	17.5	15.5	14.0											
15, 16, 17, 18, 19, 26, 27, 89, X5, X7, X9	ISO 6162-1 Flange (21.0 MPa/ 3000 psi)				35.0	35.0	35.0	35.0	28.0	28.0	21.0	17.5	16.0	3.5	3.5	3.5
4A, 4N, 4F	ISO 6162-1 Flange (35.0 MPa/ 5000 psi)								35.0	35.0	35.0					
6E, 6F, 6G, 6N, XA, XF, XG, XN, X5, X7, X9	ISO 6162-2 Flange (42.0 MPa/ 6000 psi)				42.0		42.0	42.0	42.0	42.0	42.0					
6A	ISO 6162-2 Flange (42.0 MPa/ 6000 psi)				42.0		42.0	42.0	42.0	42.0	42.0	42.0	42.0			
8A, 8F, 8N	SAE Flange 8000 psi						56.0	56.0	56.0							
S0	Male SteckO Rigid	45.0		40.0	36.2		28.0	28.0	21.0	21.0	17.0					

Fitting end connection	Description	Inch fittings (size)									
		Maximum working pressure (MPa) – design factor 4:1									
		-4	-5	-6	-8	-10	-12	-16	-20	-24	-32
JM, JC, JS, J1, J5, J7, J9, JD	ORFS male / female	63.5		63.5	63.5	41.0	41.0	41.0	28.0	28.0	
GU	JIS / BSP swivel female 60° cone	35.0	35.0	35.0	35.0		28.0	21.0	17.5		
FU	Female JIS / BSP 30° parallel pipe swivel	35.0	35.0	35.0	35.0	28.0	28.0	21.0	17.5		
MZ	Metric swivel female 90° Elbow	35.0	35.0	35.0	35.0	28.0	28.0	21.0	17.5		
UT	JIS / BSP male 60° cone	35.0		35.0	35.0		28.0	21.0	17.5		
V1	Banjo soft seal with UNF bolt	25.0	25.0		21.5	21.5	20.0				
XU, XY	Female Metric swivel 30° Flare	35.0	35.0	35.0	35.0	28.0	28.0	21.0	17.5		

Fitting end connection	Description	Metric tube (mm) • Light series – L									
		Maximum working pressure (MPa) – design factor 4:1									
		6	8	10	12	15	18	22	28	35	42
CA, CE, CF	ISO 12151-2 swivel female with O-ring	31.5	42.5	40.0	35.0	31.5	31.5	28.0	21.0	16.0	16.0
D0, DF, DG, DK	ISO 12151-2 male stud	25.0	42.5	40.0	35.0	31.0	28.0	28.0	21.0	16.0	16.0
DX	Metric swivel female with O-ring	31.5	42.5	40.0	35.0	31.5	31.5	28.0	21.0	16.0	16.0
CW, NW	High pressure cleaning hose connection					40.0					
PW	High pressure cleaning hose connection			22.5							
EN, ET, EU	Universal push-in connector		40.0	35.0	35.0	29.5	28.0	21.5			

Fitting end connection	Description	Metric tube (mm) • Metric										
		Maximum working pressure (MPa) – design factor 4:1										
		6	8	10	12	14	16	18	20	22	25	27
49	Metric Banjo - straight (DIN 7642)	20.0	20.0	20.0	20.0	20.0	20.0	20.0	20.0	20.0	20.0	20.0
V2	Banjo soft seal with metric bolt				25.0	25.0		21.5		21.5		20.0

Fitting end connection	Description	Metric tube (mm) • Heavy series – S									
		Maximum working pressure (MPa) – design factor 4:1									
		6	8	10	12	14	16	20	25	30	38
C9, 0C, 1C	ISO 12151-2 swivel female with O-ring	63.0	63.0	63.0	63.0	63.0	42.0	42.0	42.0	42.0	42.0
D2	Male stud	63.0	63.0	63.0	63.0	63.0	42.0	42.0	42.0	42.0	42.0

Hose fittings nomenclature

End configuration	Description	Standards	Common terms
01	Male NPTF Pipe – Rigid – Straight	SAE J476A / J516	AGN
02	Female NPTF Pipe – Rigid – Straight	SAE J476A / J516	
03	Male JIC 37° – Rigid – Straight	ISO12151-5-S	AGJ
04	Male SAE 45° – Rigid – Straight	SAE J516	
05	Male SAE Straight Thread with O-ring – Rigid – Straight	ISO 11926, SAE J516	
06	Female JIC 37° Swivel – Straight	ISO12151-5-SWS	DKJ
06/68	Female – JIC 37° / SAE 45° Dual Flare – Swivel – Straight	ISO12151-5-SWS	DKJ
07	Female NPSM Pipe Swivel		
08	Female SAE 45° – Swivel – Straight	SAE J516	
0C	Female Metric 24° – Heavy Series with O-ring – Swivel – 45° Elbow	ISO 12151-2 – SWE 45°-S	DKOS 45°
0G	Male O-ring Straight		
0L	Male O-ring 90° Elbow		
11	„Ferrul-Fix“		
12	Female SAE Flareless Swivel – Straight (24° Cone)		
13	Male NPTF Pipe Swivel	SAE J476A / J516	
15	ISO 6162-1 – Flange Head – Straight	ISO 12151-3-S-L	SFL / 3000 psi
15/4A	ISO 6162-1 – Flange Head – Straight / SAE Flange Head (5000 psi)	ISO 12151-3-S-L	SFL
16	ISO 6162-1 – Flange Head – 22.5° Elbow	ISO 12151-3-E22ML	SFL 22.5° / 3000 psi
17	ISO 6162-1 – Flange Head – 45° Elbow	ISO 12151-3 – E45 – L	SFL 45° / 3000 psi
17/4F	ISO 6162-1 – Flange – 45° Elbow – 45° Elbow (5000 psi)	ISO 12151-3 – E45S – L	SFL 45°
18	ISO 6162-1 – Flange – 67.5° Elbow		SFL 67.5°
19	ISO 6162-1 – Flange Head – 90° Elbow	ISO 12151-3 – E – L	SFL 90° / 3000 psi
19/4N	ISO 6162-1 – Flange Head – 90° Elbow (5000 psi)	ISO 12151-3-E-L	SFL 90°
1C	Female Metric 24° – Heavy Series with O-ring – Swivel – 90° Elbow	ISO 12151-2-SWE-S	DKOS 90°
1D	Metric Standpipe – Light Series – Rigid – Straight	ISO 8434-1	BEL
1L	Male NPTF Pipe Swivel – 90° Elbow		
26	ISO 6162-1 Flange – 30° Elbow		SFL 30°
27	ISO 6162-1 Flange – 60° Elbow		SFL 60°
28	SAE Male Inverted 45° Elbow		
33	Male JIC 37° – Rigid – 45° Elbow	ISO 12151-5	AGJ 45°
34	Inch Standpipe (Brass)		
37	Female JIC 37° – Swivel – 45° Elbow	ISO 12151-5-SWE 45°	DKJ 45°
37/3V	Female JIC 37° / SAE 45° – Dual Flare – Swivel Female 45° Elbow	ISO 12151-5-SWE 45°	DKJ 45°
39	Female JIC 37° – Swivel – 90° Elbow	ISO 12151-5-SWES	DKJ 90°
39/3W	Female JIC 37° / SAE 45° – Dual Flare – Swivel Female 90° Elbow	ISO 12151-5-SWES	DKJ 90°
3D	Metric Standpipe – Heavy Series – Rigid – Straight	ISO 8434-1	BES
3V	Female JIC 37°/SAE – 45° Swivel – 45° Elbow		DKJ 45°
3W	Female JIC 37°/SAE – 45° Swivel – 90° Elbow		DKJ 90°
3Y	Female JIC 37°/SAE – 45° Swivel – 90° Elbow (Long)		DKJ 90°
41	Female JIC 37° Swivel – 90° Elbow (Long)		DKJ 90°
41/3Y	Female JIC 37° / 45° Swivel Female 90° Elbow (Long)	ISO 12151-5-SWEL	DKJ 90°L
45	Male Tube O-ring Swivel – Long Pilot		

End configuration	Description	Standards	Common terms
49	Metric Banjo – Straight	DIN 7642	
4A	ISO 6162-1 – Flange – Straight (5000 psi)		
4F	ISO 6162-1 – Flange – 45° Elbow (5000 psi)		
4N	ISO 6162-1 – Flange – 90° Elbow (5000 psi)		
59	Female Tube O-ring Swivel – Long Pilot		
59PT	Male Tube O-ring Swivel – Long Pilot	With Charge Port at 180° for 134a	
5C	60° Cone Swivel Female		
5D	Metric Standpipe – Light Series – Rigid – 90° Elbow	ISO 8434-1	BEL 90°
5G	Male Tube O-ring Rigid Port (3 step) Straight		
5GPR	Female Tube O-ring Rigid Port (3 step) Straight	With Charge Port for R12	
5H	Female Tube O-ring Swivel – 45° Elbow – Short Pilot		
5K	Male Tube O-ring Swivel – 90° Elbow – Short Pilot		
5LPR	Female Tube O-ring Swivel – 90° Elbow – Long Pilot		
5LPT	Female Tube O-ring Swivel – 90° Elbow – Long Pilot	With Charge Port at 180° for 134a	
5MPR	Male Tube O-ring Swivel – 90° Elbow – Long Pilot	With Charge Port at 180° for R12	
5MPV	Male Tube O-ring Swivel – 90° Elbow – Long Pilot	With Charge Port at 270° for 134a	
5N	Female Tube O-ring Swivel – 45° Elbow – Long Pilot		
5P	Female Tube O-ring Swivel – 45° Elbow – Long Pilot		
5R	Male Tube O-ring Swivel – 45° Elbow – Short Pilot		
5S	Female Tube O-ring Swivel – Short Pilot		
5T	Female Tube O-ring Swivel – 90° Elbow – Short Pilot		
5V	Female Compressor – Swivel 45° Elbow		
5W	Female Compressor – Swivel 90° Elbow		
5Z	Female Compressor – Swivel 90° Elbow – Block Type		
67	SAE Male Inverted Flare Swivel – 45° Elbow		
68	Female JIC 37° / SAE 45° Swivel		DKJ
69	SAE Male Inverted Flare Swivel – 90° Elbow		
6A	ISO 6162-2 – Flange – Straight	ISO 12151-3-S-S	SFS / 6000 psi
6B	ISO 6162-2 – Flange – 22.5° Elbow		SFS 22.5°
6C	60° Cone Swivel Female – 45° Elbow		
6E	ISO 6162-2 – Flange – 30° Elbow		SFS 30°
6F	ISO 6162-2 – Flange – 45° Elbow	ISO 12151-3 – E45-S	SFS 45° / 6000 psi
6G	ISO 6162-2 – Flange – 60° Elbow		SFS 60°
6N	ISO 6162-2 – Flange – 90° Elbow	ISO 12151-3 – E-S	SFS 90° / 6000 psi
77	Female SAE 45° Swivel – 45° Elbow		
79	Female SAE 45° Swivel – 90° Elbow		
7C	60° Cone Swivel Female – 90° Elbow		
7D	Male Standpipe Metric S – Rigid – 90° Elbow		BES 90°
82	Push-Lok® Union		
89	ISO 6162-1 – Flange – 90° Elbow (Long) – Standard Series		
8A	Flange – Straight – 8000 psi		
8F	Flange – 45° Elbow – 8000 psi		
8N	Flange – 90° Elbow – 8000 psi		
91	Male BSP Taper Pipe – Rigid – Straight	BS5200	AGR-K

End configuration	Description	Standards	Common terms
92	Female BSP Parallel Pipe – Swivel – Straight (60° Cone)	BS5200-A	DKR
93	Female JIC 37° – Swivel – 90° Elbow (Block Type)		
9B	Metric – Swivel Female 45° Elbow – Light Series		
9C	Light Series Metric Swivel Female 90° Elbow		
AF	Male BSP Parallel Pipe – Rigid – Straight (with O-ring Seal)		
B1	Female BSP Parallel Pipe – Swivel – 45° Elbow (60° Cone)	BS 5200-D	DKR 45°
B2	Female BSP Parallel Pipe – Swivel – 90° Elbow (60° Cone)	BS 5200-B	DKR 90°
B4	Female BSP Parallel Pipe – Swivel – 90° Elbow Block Type (60° Cone)	BS 5200-E	DKR 90°
B5	Female BSP Parallel Pipe – Swivel – Straight (Flat Seat)		
C0	Female Metric – Very Light Series LL – Swivel – Straight (Ball Nose)		DKM
C3	Female Metric – Light Series – Swivel – Straight (Ball Nose)		DKL
C4	Female Metric – Light Series – Swivel – 45° Elbow (Ball Nose)		DKL 45°
C5	Female Metric – Light Series – Swivel – 90° Elbow (Ball Nose)		DKL 90°
C6	Female Metric – Heavy Series – Swivel – Straight (Ball Nose)		DKS
C7	Female Metric Swivel – 45° Elbow “Heavy” Series		DKS 45°
C8	Female Metric Swivel – 90° Elbow “Heavy” Series		DKS 90°
C9	Female Metric 24° – Heavy Series with O-ring – Swivel – Straight	ISO 12151-2-SWS-S	DKOS
CA	Female Metric 24° – Light Series with O-ring – Swivel – Straight	ISO 12151-2-SWS-L	DKOL
CE	Female Metric 24° – Light Series with O-ring – Swivel – 45° Elbow	ISO 12151-2-SWE 45°-L	DKOL 45°
CF	Female Metric 24° – Light Series with O-ring – Swivel – 90° Elbow	ISO 12151-2-SWE-L	DKOL 90°
CW	Power Cleaner Connection		
D0	Male Metric 24° – Light Series – Rigid – Straight	ISO 12151-2-S-L	CEL
D2	Male Metric 24° – Heavy Series – Rigid – Straight	ISO 12151-2-S-S	CES
D9	Male BSP Parallel Pipe – Rigid – Straight (60° Cone)	BS5200	AGR
DD	Metric Standpipe – Light Series – Rigid – 45° Elbow		BEL 45°
DE	Double Banjo Union		
DF	Male Metric L – Rigid – 45° Elbow (24° Cone)		DIN 20078 Form D
DG	Male Metric L – Rigid – 90° Elbow (24° Cone)		DIN 20078 Form D
DP	Metric Swivel Female Tee / Male Stud		
DR	Metric Swivel Female Tee		
DS	Metric Swivel Female Tee / Standpipe		
DW	Female Metric Swivel „Light” Series		TGL
EA	BSP Swivel Female with O-ring (60° Cone)	BS 5200, ISO 12151-6	DKOR
EB	BSP Swivel Female with O-ring – 45° Elbow (60° Cone)	BS 5200, ISO 12151-6	DKOR 45°
EC	BSP Swivel Female with O-ring – 90° Elbow (60° Cone)	BS 5200, ISO 12151-6	DKOR 90°
EN	UPTC – Male – Straight		
ET	UPTC – Male – 90° Elbow		
EU	UPTC – Male – 45° Elbow		
FF	Metru-Lok Swivel Female		
FU	Female BSP Parallel Pipe – Swivel – Straight (30° Flare)	ISO 228-1, JIS B8363	GUI
GU	Female BSP Parallel Pipe – Swivel – Straight (60° Cone)	ISO 228-1, JIS B8363	GUO
J1	Female ORFS – Swivel – 90° Elbow – Long Drop	ISO 12151-1 – SWEL, SAE J 516	ORFS 90° L
J5	Female ORFS – Swivel – 90° Elbow – Medium Drop	ISO 12151-1 – SWEM	ORFS 90° M
J7	Female ORFS – Swivel – 45° Elbow	ISO 12151-1 – SWE 45°, SAE J516	ORFS 45°

End configuration	Description	Standards	Common terms
J9	Female ORFS – Swivel – 90° Elbow – Short Drop	ISO 12151-1 – SWES, SAE J516	ORFS 90°
JC	Female ORFS – Swivel – Straight – Short	ISO 12151-1 – SWSA, SAE J516	ORFS
JD	Male ORFS – Bulkhead with Locknut – Straight (with O-ring)	ISO 12151-1 – SAE J516	
JM	ORFS Male	ISO 12151-1-S, SAE J516	
JS	ORFS Swivel Female (Long)	ISO 12151-1-SWSB, SAE J516	ORFS
L9	Female JIC 37° – Swivel – 90° Elbow – Medium Drop	ISO 12151-5-SWEM	DKJ 90° M
MU	Female Metric – Swivel – Straight (30° Flare)	JIS B8363	MU
MZ	Female Metric – Swivel – 90° Elbow (30° Flare)	JIS B8363	
NM	Male BSP Parallel Pipe – L Series – Rigid – Straight – ED-Seal	ISO 1179	
NW	Female Kärcher Metric Cleaning Hose Fitting – Swivel – Straight		
PW	Male Kärcher Metric Cleaning Hose Fitting – Rigid – Straight		
PY	Flange – 24° Male – French Gas – Straight		
S2	Female NPTF Pipe Swivel		
S5	Male Tube O-ring Swivel – Short Pilot		
T1	Male Refrigerant Tube Mender – Straight (with Nut and Ferrule)		
UT	Male BSP Taper Pipe – Rigid – Straight (60° Cone)	JIS B 8363-R	
V1	Ermeto standard Pressure Banjo – Straight (with UNF Bolt and O-ring)		
VW	Push In Connector	(VW-Standard 39-V-16619)	
VW121	BSP Swivel Female	(VW-Norm 39-V-16631)	
VW39D	Push In Connector	(VW-Standard 39D-1401)	
WKS	Rubber hand grip		
X5	Flange – Straight – Full flange system for ISO 6162-1 or ISO 6162-2		
X7	Flange – 45° Elbow – Full flange system for ISO 6162-1 or ISO 6162-2		
X9	Flange – 90° Elbow – Full flange system for ISO 6162-1 or ISO 6162-2		
XA	Caterpillar® Flange Head – Straight		
XF	Caterpillar® Flange Head – 45° Elbow		
XG	Caterpillar® Flange Head – 60° Elbow		
XN	Caterpillar® Flange Head – 90° Elbow		
XU	Female Metric – Swivel – Straight (30° Flare)	JIS B8363	
XY	Female Metric – Swivel – 90° Elbow (30° Flare)	JIS B8363	
YW	Male Standpipe – Rigid – Straight – A-Lok	Metric Size Tube O.D. with Vee Notch	

Classification bodies

The mission of classification bodies is to contribute to the development and implementation of technical standards for the protection of life, property and the environment.

- (1) **Det Norske Veritas - Germanischer Lloyd (DNV-GL)**
Norwegian service company for managing risk in ship classification, off-shore industry, etc...
German independent organisation of technical experts approving products for the German mercantile marine and the energy sector – GLIS (oil and gas, wind energy, etc...)
- (2) **Registro Italiano Navale (RINA)**
Italian company offering certification, verification, control, assistance in marine, energy & process, transport and industry.
- (3) **Lloyd's Register (LR)**
English independent organisation providing certification around the world. Marine services, Rail services and Energy services are their main activities.
- (4) **American Bureau of Shipping (ABS)**
US company providing rules for safety in the marine environment.
- (5) **European Rail Standard (EN 45545)**
Railway application – Fire protection on railway vehicles. Requirements for fire behavior of materials and components (hose and hose assemblies).
- (6) **US Department of Transportation (DOT)**
US organisation providing certifications to ensure a fast, safe, efficient, accessible and convenient transportation system in this country.
- (7) **US Coast Guard (USCG)**
Provides maritime safety, law enforcement, recreational boating safety, and environmental protection information for merchant mariners. The approved hoses are not accepted for all applications automatically. If the column contains "H", the hose is accepted for hydraulic systems only and not for fuel and lube systems.
- (8) **Mine Safety and Health Administration (MSHA)**
US organisation for safety in the mining industry
- (9) **MarED**
MarED is the Group of Notified Bodies for the Implementation of the Marine Equipment Directive.
- (10) **Bureau Veritas (BV)**
Bureau Veritas is today the most widely recognized certification body in the world, offering solutions in the key strategic fields of operations: Quality, Health & Safety, Environment and Social Responsibility.
- (11) **Verteidigungs-Gerätenorm (VG)**
German Organisation providing approvals for military equipment.
- (12) **TEST**
JOAiCW TEST (Jednostka Opiniująca, Atestująca i Certyfikująca Wzrosty TEST – Product Assessment, Approval and Certification Body TEST) is a private certification body authorised to test and certify equipment and components for use in Polish underground mines.

EN	European standard
ISO	International Organisation for Standardization
SAE	Society of Automotive Engineers (US organisation)

Approvals for Parker hydraulic hoses

Description (1)-(12) see Ab-16

Hose	Construction	Standard	DMV-GL (1)	RINA (2)	LR (3)	ABS (4)	Rail (EN 45545) (5)	DOT (6)	USCG (7)	MSHA (8)	MarED (9)	BV (10)	VG (11)	TEST (12)
801Plus	1 braid, fibre													
830M	1 braid, fibre													
837BM	1 braid, fibre													
837PU	1 braid, fibre													
801RH	1 braid, fibre						X							
804	1 braid, fibre													
821FR	1 braid, fibre													
836	1 braid, fibre									X				
846	1 braid, fibre									X				
838M	1 braid, fibre													
681	1 braid, fibre	EN 854-2TE												
611HT	1 braid, fibre	EN 854-R6								X				
681DB	1 braid, fibre	EN 854-2TE					X							
201	1 braid, wire	SAE 100R5 - SAE J1402 All						X						
206	1 braid, wire	SAE 100R5 - SAE J1402 All						X						
213	1 braid, wire	SAE J1402 AI						X						
293	1 braid, wire	SAE J1402 AI						X						
221FR	1 braid, wire	SAE J1527 R3	X			X			H	X				
285	1 braid, fibre	SAE J2064 C												
244	1 braid, wire	SAE J2064 B Class I												

Low pressure

Push-Lok

Low pressure

Transport + Hydraulic

Transportation

Fire retardant

Refrigeration



Description (1)-(12) see Ab-16

Approvals for Parker hydraulic hoses

Medium pressure

Hose	Construction	Standard	DMV-GL (1)	RIMA (2)	LR (3)	ABS (4)	Rail (EN 45545) (5)	DOT (6)	USCG (7)	MSHA (8)	MarED (9)	BV (10)	VG (11)	TEST (12)
187	2 braids, wire	Exceeds ISO 18752-AS								X				
187TC/ST	2 braids, wire	Exceeds ISO 18752-AS												
387	1/2 braids, wire ¹	Exceeds ISO 18752-AC - ISO 18752-BC ²								X				
387TC/ST	1/2 braids, wire ¹	Exceeds ISO 18752-AC - ISO 18752-CC ²	X		X	X								
487	1/2 braids, wire ¹	Exceeds ISO 18752-AC - ISO 18752-BC ²								X				
487TC/ST	1/2 braids, wire ¹	Exceeds ISO 18752-AC - ISO 18752-CC ²	X		X	X								
BCH1	1 braid, wire	EN 857 1SC - ISO 11237												
BCH2	2 braids, wire	EN 857 2SC - ISO 11237												
421SN	1 braid, wire	EN 853-1SN - ISO 1436-1SN/R1AT - SAE 100R1AT	X	X	X	X				X	X	X	X	
301SN	2 braids, wire	EN 853-2SN - ISO 1436-2SN/R2AT - SAE 100R2AT	X	X	X	X				X	X	X	X	
441	1/2 braids, wire ¹	ISO 11237-R16 - SAE 100R16												
492	1 braid, wire	Exceeds EN 857-1SC - ISO 11237-1SC	X	X	X	X				X	X	X	X	
462	2 braids, wire	Exceeds EN 857-2SC - ISO 11237-2SC	X	X	X	X				X	X	X	X	
421TC	1 braid, wire	EN 853 1SN - ISO 1436 Type 1 - SAE 100R1AT												
462TC	2 braids, wire	Exceeds EN 857-2SC - ISO 11237-2SC	X			X				X				
471TC	2 braids, wire	EN 857-2SC - ISO 11237-2SC								X				
492TC	1 braid, wire	EN 857-1SC - ISO 11237-1SC	X			X				X				
492ST	1 braid, wire	EN 857-1SC - ISO 11237-1SC	X			X								
462ST	2 braids, wire	EN 857-2SC - ISO 11237-2SC	X			X								
426	1 braid, wire	SAE 100R1AT				X				X				
436	2 braids, wire	SAE 100R16				X				X				
461LT	2 braids, wire	Exceeds EN 857-2SC - ISO 11237-2SC												
HT2	2 braids, wire	Parker specification												
304	2 braids, wire	SAE 100R2AT												
441RH	1/2 braids, wire ¹	ISO 11237-R16 - SAE 100R16					X							
421RH	1 braid, wire	EN 853-1SN - ISO 1436-1SN/R1AT - SAE 100R1AT					X							
477RH	2 braids, wire						X							
493	1 braid, wire													
463	2 braids, wire													
412	1 braid, wire													
412ST	1 braid, wire													
421WC	1 braid, wire	ISO S1436-1SN/R1AT - SAE 100R1AT												
477	2 braids, wire									X				
477TC	2 braids, wire													
477ST	2 braids, wire													
692	1/2 braids, wire ¹	Exceeds SAE 100R17												
692TWIN	1/2 braids, wire ¹	Exceeds SAE 100R17												
692TC	1/2 braids, wire ¹	Exceeds SAE 100R17								X				
811	1 braid, 1 steelspiral	SAE 100R4	X			X								
811S	1 braid, 1 steelspiral	Exceeds SAE 100R4	X			X								
881	1 braid, 1 steelspiral	SAE 100R4												
462PU	2 braids, wire	Exceeds EN 857 2SC - ISO 11237 Typ 2SC												
462PU Twin	2 braids, wire	Exceeds EN 857 2SC - ISO 11237 Typ 2SC												
692PU	1/2 braids, wire ¹													
692PU Twin	1/2 braids, wire ¹													

1: The hose construction depends on the hose ID (size). 2: The standard depends on the hose ID (size). For details, please refer to the respective hose page in this catalogue.

Description (1)-(12) see Ab-16

Approvals for Parker hydraulic hoses

High pressure

Hose	Construction	Standard	DWV-GL (1)	RINA (2)	LR (3)	ABS (4)	Rail (EN 45545) (5)	DOT (6)	USCG (7)	MSHA (8)	MarED (9)	BV (10)	VG (11)	TEST (12)
GlobalCore	722	4 spiral, wire												
	722TC	4 spiral, wire	X		X	X			X	X				
	722ST	4 spiral, wire	X		X	X			X	X				
GlobalCore Compact Spiral	787	4/6 spiral, wire ¹												
	787TC	4/6 spiral, wire ¹	X		X	X			X	X				
	787ST	4/6 spiral, wire ¹	X		X	X			X	X				
	797	4/6 spiral, wire ¹												
	797TC	4/6 spiral, wire ¹	Exceeds ISO 18752-DC - ISO 18752-CC ²	X		X			X	X				
	797ST	4/6 spiral, wire ¹	Exceeds ISO 18752-DC - ISO 18752-CC ²	X		X			X	X				
Standard	372	3 braids, wire	X		X	X					X			
	371LT	3 braids, wire												
	372TC	3 braids, wire	X							X				
Standard	372RH	3 braids, wire					X							
	SX35	4 spiral, wire												
	SX42	4/6 spiral, wire ¹												
	701	4 spiral, wire	X									X		
	731	4 spiral, wire	Exceeds EN 856-4SP - ISO 3862-4SP Exceeds EN 856-4SH - ISO 3862-4SH											
Low temperature	SX35LT	4 spiral, wire												
	SX42LT	4/6 spiral, wire ¹												
Phosphat-Ester	774	4 spiral, wire												
	F42	4/6 spiral, wire ¹												
High abrasion resistance MSHA approved	SX35TC	4 spiral, wire												
	SX42TC	4/6 spiral, wire ¹								X				
	701TC	4 spiral, wire								X				
	731TC	4 spiral, wire								X				
Railway	797RH	4/6 spiral, wire ¹					X							
	H31	4 spiral, wire	X	X	X	X					X	X		
Standard	H29	4 spiral, wire	X		X	X					X	X		
	R35	4/6 spiral, wire ¹	X		X	X					X	X		
	R42	4/6 spiral, wire ¹	X		X	X					X	X		
	H31TC	4 spiral, wire									X	X		X
High abrasion resistance MSHA approved	H29TC	4 spiral, wire	X		X	X					X	X		X
	R35TC	4/6 spiral, wire ¹	X		X	X					X	X		X
	RD35TC	6 spiral, wire												
	RS35TC	6 spiral, wire	X		X	X								X
	R42TC	4/6 spiral, wire ¹	X		X	X					X	X		X
	R50TC	4/6 spiral, wire ¹									X	X		
	R56TC	4 spiral, wire									X	X		
	H31ST	4 spiral, wire	X		X	X					X	X		
	H29ST	4 spiral, wire	X		X	X					X	X		
	R42ST	4/6 spiral, wire ¹	X		X	X					X	X		
Water-Blasting Firearmor BOP	BPK	4/6 spiral, wire ¹												
	FA35	4/6 spiral, wire ¹												
	CEM69TC	6 spiral, wire										X		
		Standard		API 7K FLSL - ISO 14693										

¹: The hose construction depends on the hose ID (size). ²: The standard depends on the hose ID (size). For details, please refer to the respective hose page in this catalogue.

Conversion chart

	Unit	Base unit	Conversion unit	Factor
Length	1 inch	in	mm	25.4
	1 millimetre	mm	in	0.03934
	1 foot	ft	m	0.3048
	1 metre	m	ft	3.28084
Area	1 square inch	sq in	cm ²	6.4516
	1 square centimetre	cm ²	sq in	0.1550
Volume	1 gallon (UK)	gal	l	4.54596
	1 litre	l	gal (UK)	0.219976
	1 gallon (US)	gal	l	3.78533
	1 litre	l	gal (US)	0.264177
Weight	1 pound	lb	kg	0.453592
	1 kilogramme	kg	lb	2.204622
Torque	1 pound foot	lb • ft	N • m	1.488164
	1 Newton metre	N • m	lb • ft	0.671969
Pressure	1 pound per square inch	psi	bar	0.06895
	1 bar	bar	psi	14.5035
	1 pound per square inch	psi	MPa	0.006895
	1 mega pascal	MPa	psi	145.035
	1 kilo pascal	kPa	bar	0.01
	1 bar	bar	kPa	100
	1 mega pascal	MPa	bar	10
	1 bar	bar	MPa	0.1
Velocity	1 foot per second	ft / s	m / s	0.3048
	1 metre per second	m / s	ft / s	3.28084
Flow rate	1 gallon per minute (UK)	gal / min.	l / min.	4.54596
	1 litre per minute	l / min.	gal / min. (UK)	0.219976
	1 gallon per minute (US)	gal / min.	l / min.	3.78533
	1 litre per minute	l / min.	gal / min. (US)	0.264178
Temperature	Fahrenheit degree	°F	°C	5/9 • (°F-32)
	Celsius degree	°C	°F	°C • (9/5) +32

(UK) Unit of United Kingdom
 (US) Unit of USA

Temperature and pressure chart

Reference 201, 206, 213 and 293 hose.

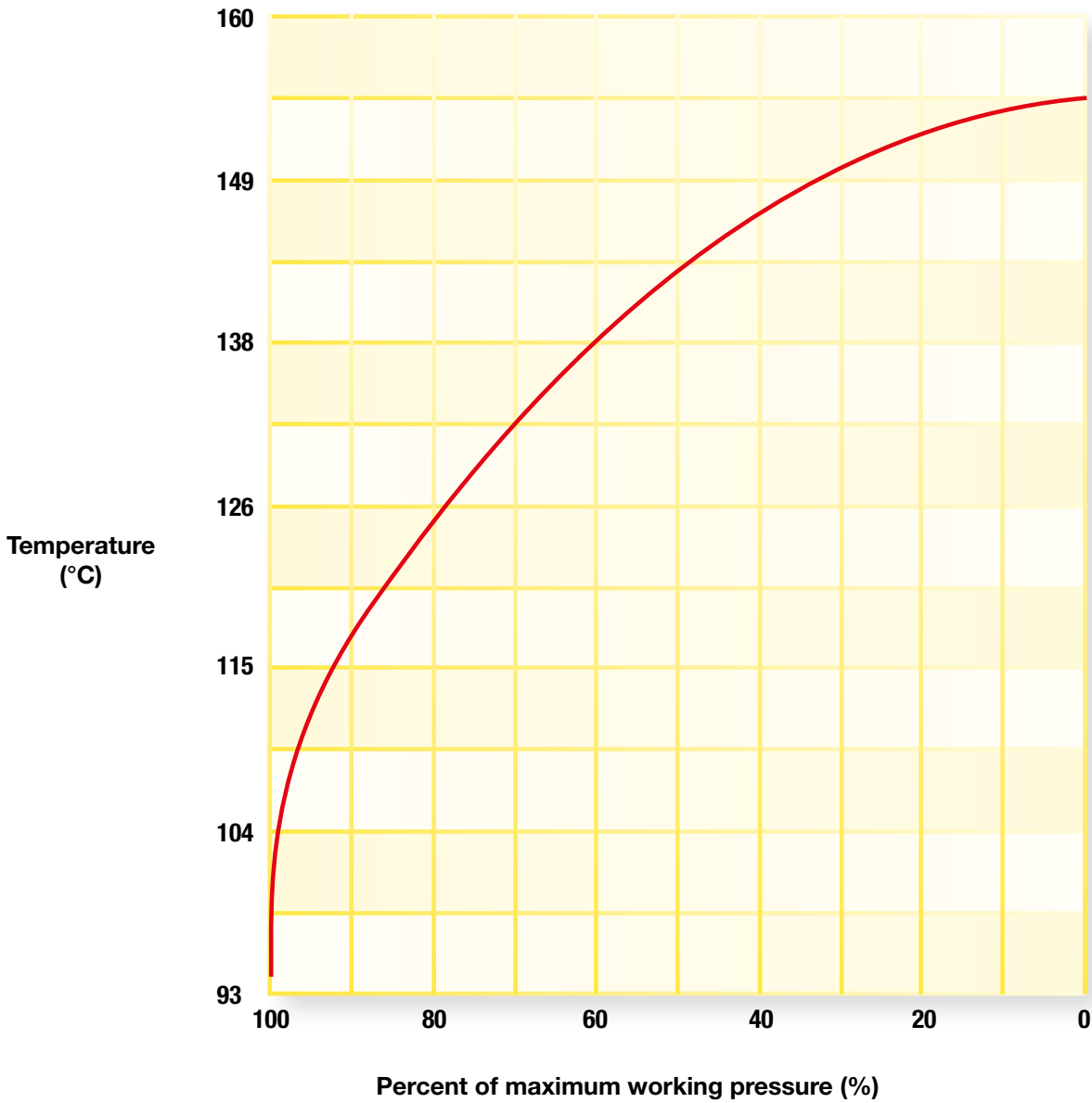

EXAMPLE: 201-8 hose to be used at 121 °C

Maximum Working Pressure up to 100 °C	x	Multiplication Factor from Chart	=	Maximum Working Pressure at 121 °C
13.8 MPa (2000 psi)	x	85%	=	11.7 MPa (1700 psi)

Flow capacity nomogram

The chart below is provided as an aid in the determination of the correct hose size.

Example: at 10 gallons per minute (gal/min), what is the proper hose size within the recommended velocity range for pressure lines?

Locate 10 gallons per minute in the left-hand column and 20 feet per second in the right-hand column (the maximum recommended velocity range for pressure lines). Lay a straight line across these two points.

The inside diameter shown in the centre column is above -6 so we have to use -8 (1/2"). For suction hose, follow the same procedure except use recommended velocity range for intake lines in the right-hand column.

- where: Q = flow in gallons per minute (gal/min & l/min)
- V = velocity in feet per second (f/s & m/s)
- d = hose inside diameter (mm & dash size)

Example
 Flow Q = 45 l/m
 Velocity V = 6,1 m/s
 Konstant K = 21,2025

$$D = \sqrt{\frac{Q * K}{V}} = \sqrt{\frac{45 \frac{l}{m} * 21,2025}{6,1 \frac{m}{s}}} = 12,5 \text{ mm}$$

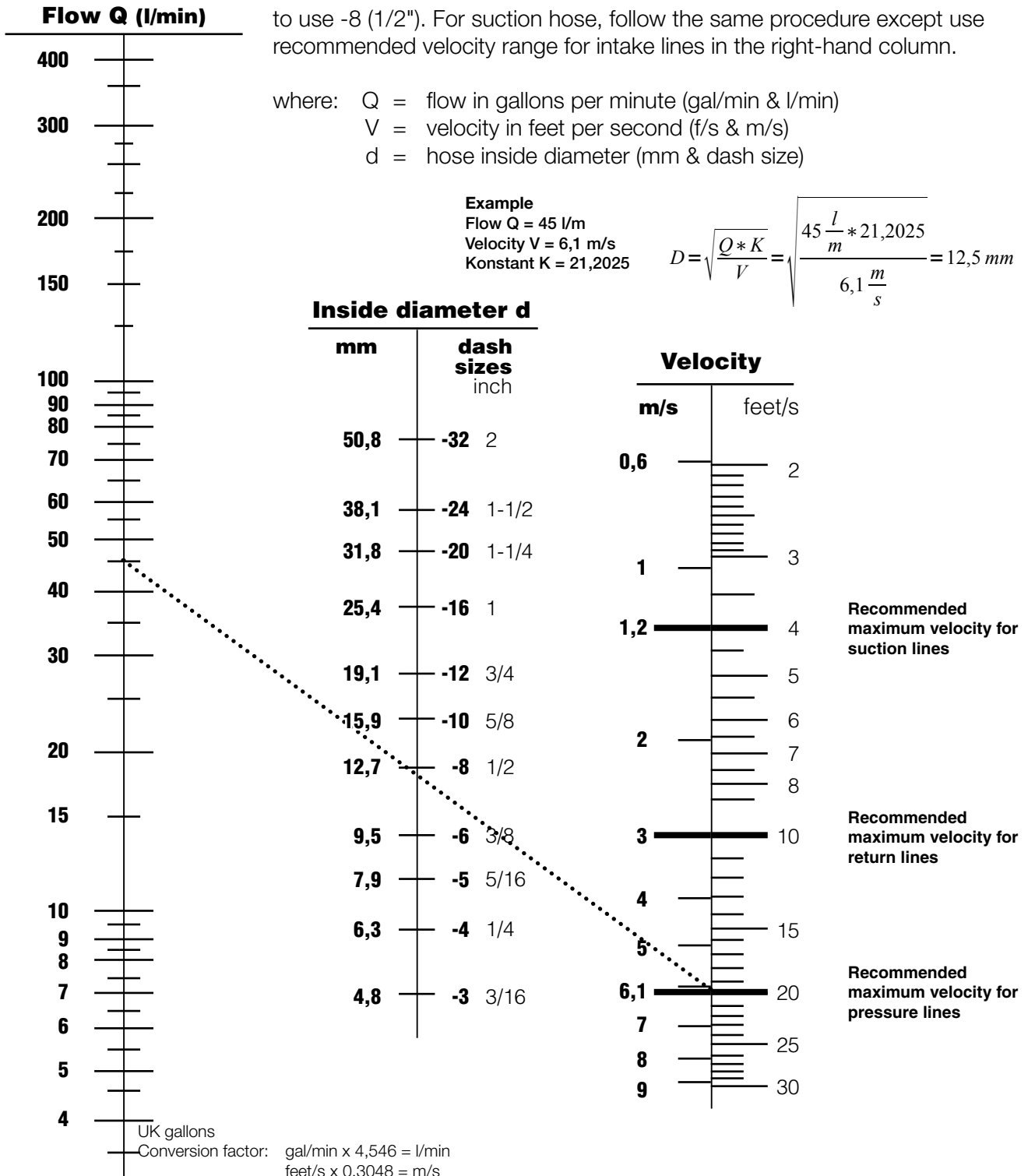

* Recommended velocities are according to hydraulic fluids of maximum viscosity 315 S.S.U. at 38°C working at roomtemperature within 18° and 68°C.

The correct method to fit female swivel ends

To ensure a leakproof seal between swivel female hose ends shown in this catalogue and the appropriate adaptors it is necessary to follow the procedure below which is different from hydraulic tube assembly.

Flats From Wrench Resistance (FFWR)

Parker's recommended assembly method for JIC 37° flare, SAE 45° flare and ORFS swivel female is Flats From Wrench Resistance (FFWR). The torque values assigned by size are for reference only, and are only

applicable to Parker system components using the FFWR method with trivalent chromate passivation on zinc plating of carbon steel components without lubrication.

Metal-to-metal seal

Screw the nut up hand tight and then tighten further with a spanner according to the values mentioned in the table below. Ensure that in all cases the hose is correctly aligned before tightening the nut onto the corresponding adaptor.

Spanner torque values

Metric swivel female

Thread metric	Tube O.D.	Nm	
		nominal	min. - max.
M 12x1.5	06L	16	15 - 17
M 14x1.5	08L	16	15 - 17
M 16x1.5	10L	26	25 - 28
M 18x1.5	12L	37	35 - 39
M 22x1.5	15L	47	45 - 50
M 26x1.5	18L	89	85 - 94
M 30x2	22L	116	110 - 121
M 36x2	28L	137	130 - 143
M 45x2	35L	226	215 - 237
M 52x2	42L	347	330 - 363
M 14x1.5	06S	26	25 - 28
M 16x1.5	08S	42	40 - 44
M 18x1.5	10S	53	50 - 55
M 20x1.5	12S	63	60 - 66
M 22x1.5	14S	79	75 - 83
M 24x1.5	16S	84	80 - 88
M 30x2	20S	126	120 - 132
M 36x2	25S	179	170 - 187
M 42x2	30S	263	250 - 275
M 52x2	38S	368	350 - 385

BSP swivel female

Thread BSPP	size	Nm	
		nominal	min. - max.
G1/4	-4	20	15 - 25
G3/8	-6	34	27 - 41
G1/2	-8	60	42 - 76
G5/8	-10	69	44 - 94
G3/4	-12	115	95 - 135
G1	-16	140	115 - 165
G1-1/4	-20	210	140 - 280
G1-1/2	-24	290	215 - 365
G2	-32	400	300 - 500

Note

Values given in tables are typical to achieve the recommended assembly methods when fitting material is steel zinc plated. For other materials different values will be applicable (see our recommendations for other materials on this page).

JIC 37° swivel female

Thread UNF	size	Flats From Wrench Resistance (FFWR)	Swivel Nut Torque Nm (Ref)
7/16-20	-4	2	18
1/2-20	-5	2	20
9/16-18	-6	1-1/2	30
3/4-16	-8	1-1/2	57
7/8-14	-10	1-1/2	81
1.1/16-12	-12	1-1/4	114
1.5/16-12	-16	1	160
1.5/8-12	-20	1	228
1.7/8-12	-24	1	265
2.1/2-12	-32	1	360

ORFS swivel female

Thread UNF	size	Flats From Wrench Resistance (FFWR)	Swivel Nut Torque Nm (Ref)
9/16-18	-4	1/2 to 3/4	25
11/16-16	-6	1/2 to 3/4	40
13/16-16	-8	1/2 to 3/4	55
1-14	-10	1/2 to 3/4	80
1.3/16-12	-12	1/3 to 1/2	115
1.7/16-12	-16	1/3 to 1/2	150
1.11/16-12	-20	1/3 to 1/2	205
2-12	-24	1/3 to 1/2	315
2-1/2x12	-32	-	-

Note: The assembly torques listed for UNF threads are higher than the test torques published in SAE J1453.

The torque values for other materials are as follows:

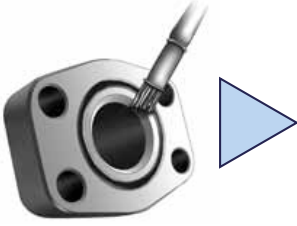
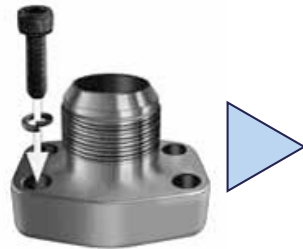
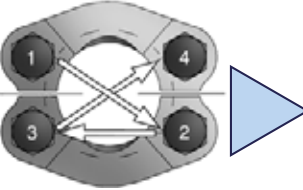
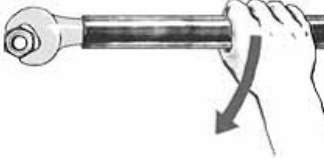

- Brass fittings and adapters
65 % of the torque value for steel
- Stainless steel and Monel
Use 5% higher than listed for steel.
Threads to be lubricated for these materials.
- Dissimilar metals
Use torque value designated for the lower of the two metals.
- All fittings are dry except as noted above.

The correct method to fit ISO 6162-1 flange



			
<ul style="list-style-type: none"> • Make sure sealing surfaces are free of burrs, nicks, scratches or any contamination • Lubricate the O-ring with system fluid or compatible lubricant 	<ul style="list-style-type: none"> • Position flange and clamp halves • Place lock washers on bolts and bolt through clamp halves 	<ul style="list-style-type: none"> • Hand tighten bolts • Torque bolts in diagonal sequence in small increments to the appropriate torque level listed in chart 	<ul style="list-style-type: none"> • Tighten bolts according to chart

Spanner torque values



ISO 6162-1 flange

DN	Inch	Size	 G Thread metric	Assembly torque Tolerances: max. 10%; min. 0% Nm	 G Thread UNC (Inch)	Assembly torque Tolerances: max. 10%; min. 0% Nm
13	1/2	-8	M8x1.25	24	5/16-18	24
19	3/4	-12	M10x1.5	50	3/8-16	43
25	1	-16	M10x1.5	50	3/8-16	43
32	1-1/4	-20	M10x1.5	50	7/16-14	70
38	1-1/2	-24	M12x1.75	92	1/2-13	105
51	2	-32	M12x1.75	92	1/2-13	105
64	2-1/2	-40	M12x1.75	92	1/2-13	105
76	3	-48	M16x2	210	5/8-11	210
89	3-1/2	-56	M16x2	210	5/8-11	210
102	4	-64	M16x2	210	5/8-11	210
127	5	-80	M16x2	210	5/8-11	210

ISO 6162-1 flange 5000 psi

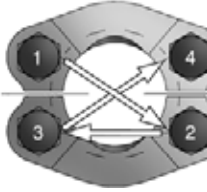
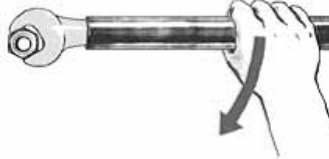

DN	Inch	Size	 G Thread metric	Assembly torque Tolerances: max. 10%; min. 0% Nm	 G Thread UNC (Inch)	Assembly torque Tolerances: max. 10%; min. 0% Nm
32	1-1/4	-20	-	-	7/16-14	70
38	1-1/2	-24	-	-	1/2-13	105
51	2	-32	-	-	1/2-13	105

The correct method to fit ISO 6162-2 flange



			
<ul style="list-style-type: none"> • Make sure sealing surfaces are free of burrs, nicks, scratches or any contamination • Lubricate the O-ring with system fluid or compatible lubricant 	<ul style="list-style-type: none"> • Position flange and clamp halves • Place lock washers on bolts and bolt through clamp halves 	<ul style="list-style-type: none"> • Hand tighten bolts • Torque bolts in diagonal sequence in small increments to the appropriate torque level listed in chart 	<ul style="list-style-type: none"> • Tighten bolts according to chart

Spanner torque values

ISO 6162-2 flange

DN	Inch	Size	 G Thread metric	Assembly torque Tolerances: max. 10%; min. 0%	
				Nm	 UNC (Inch)
13	1/2	-8	M8x1.25	24	5/16-18
19	3/4	-12	M10x1.5	50	3/8-16
25	1	-16	M12x1.75	92	7/16-14
32	1-1/4	-20	M12x1.75	130	1/2-13
32	1-1/4	-20	M14x2	150	-
38	1-1/2	-24	M16x2	210.0	5/8-11
51	2	-32	M20x2.5	400.0	3/4-10
64	2-1/2	-40	M24x3	600.0	-
76	3	-48	M30x3.5	650.0	-

ISO 6162-2 flange 8000 psi

DN	Inch	Size	 G Thread metric	Assembly torque Tolerances: max. 10%; min. 0%	
				Nm	 UNC (Inch)
19	3/4	-12	M10x1.5	60	3/8-16
25	1	-16	M12x1.75	92	7/16-14
32	1-1/4	-20	M12x1.75	130	1/2-13
32	1-1/4	-20	M14x2	150	-

Chemical resistance table

Warning ! This chemical compatibility guide must not be used in conjunction with any other compatibility guides from previous or future catalogue editions, bulletins or publications. Incorrect use of these charts could result in death, personal injury or property damage.

Hose selection by medium and hose type

This hose compatibility chart is a ready reference of Parker hose compatibility with various fluid media. It is intended as a guide to chemical compatibility with inner tube materials and assembly lubricants applied internally.

The outer cover of the hose is intended to protect the reinforcement layer(s) from mechanical influences (abrasion, weathering etc), as such the cover compounds are not designed to exhibit the same chemical resistance as the tube compounds. The Hose Division Technical Department should be consulted about the compatibility of the cover should the application involve the extended exposure or immersion in a liquid.

The specific recommendations are based upon field experience, the advice of various polymer or fluid suppliers, and specific laboratory experiments. It must be stressed, however, that this information is offered only as a guide. Final hose selection depends also upon pressure, fluid temperature, ambient temperature, and special requirements or variations, which may not be known by Parker. Legal and other regulations must be followed with particular care.

Where an external compatibility problem may occur, or for fluids not listed, we encourage you to first contact the fluid manufacturer for a recommendation prior to contacting your Parker Field Representative or the Technical Department, Hose Products Division Europe (HPDE_Helpdesk@parker.com)

Use the chart as follows:

1. Locate medium to be carried using the Chemical Resistance Table on the following pages.
2. Select suitability of hose and fitting material from the table based on the letter rating in the table. See resistance rating key below for explanation of compatibility ratings. See list of numerals below for an explanation when a numeral, or a numeral and a letter rating are present in the table.
3. The Column headings on the Chemical Resistance Table, I, II, III, IV, V refer to specific groups of hoses.
4. Locate hose part number under Column I, II, III, IV, V. VI from the list below.
5. For fitting material availability refer to appropriate fitting section of catalogue.
6. Check hose specifications in this catalogue. Contact Hose Products Division Europe Technical Department on any items not catalogued.

Resistance rating key

A = Preferred, good to excellent with little or no change in physical properties.
 F = Fair, marginal or conditional with noticeable effects on physical properties.
 X = Unsuitable, severe effects on physical properties.
 ~ = No rating, insufficient information.

Numerals

1. For air or gaseous applications above 250 psi (1.7 MPa), the cover should be pin pricked.
2. Legal and insurance regulations must be considered. Contact HPDE Technical Department for more information.
3. Push-Lok hoses (801PLUS, 804, 821FR, 831, 836, 837BM, 837PU, 830M, 838M) are not recommended for any type of fuel.
4. Use 285 hose. The compatibility of the system's refrigeration oil with these hoses needs to be evaluated on a case by case basis. Contact HPDE Technical Department for more information. Chemical compatibility does not imply low permeation.
5. 65 °C (150 °F) maximum.
6. Satisfactory at some concentrations and temperatures, unsatisfactory at others.
7. For phosphate ester fluids use 304, 774, 804 or F42 hoses.
8. Acceptable for flushing hose assemblies.
9. 221FR hose recommended.
10. For dry air applications, hoses with inner tubes from columns IV and V are preferred. See hose specifications for maximum recommended temperatures with air.
11. 100 °C (212 °F) maximum.
12. 121 °C (250 °F) maximum.
13. Hoses for gas application are available from Parker. Please contact the Technical Department for more information about the products as well as the legal application requirements.
14. 70 °C maximum for hoses 837BM, 837PU
15. No rating / insufficient information about chemical compatibility for hoses 837BM, 837PU.

Hose types

Column I:	201, 701, 701TC, 731, 731TC, 881, H31, H29, R35, RD35TC, RS35TC, R42, H31TC, H29TC, R35TC, R42TC, H31ST, H29ST, R42ST, R50TC, R56TC, BPK, SX35, SX35LT, SX35TC, SX42, SX42LT, SX42TC, FA35
Column II:	371LT, 421TC, 421WC, 441, 441RH, 461LT, 471TC, 493, 681, 681DB, 811, 811S, HT2
Column III:	BCH1, BCH2, 187, 187TC, 187ST, 221FR, 301SN, 372, 372RH, 372TC, 387, 387ST, 387TC, 412, 412ST, 421RH, 421SN, 421TC, 462, 462ST, 462TC, 462PU, 462PU Twin, 463, 477, 477ST, 477TC, 477RH, 487, 487TC, 487ST, 492, 492ST, 492TC, 493, 692, 692TC, 692Twin, 692PU, 602PU Twin, 722, 787, 787TC, 787ST, 797, 797TC, 797ST, 797RH, 801PLUS, 801RH
Column IV:	206, 213, 293, 426, 436, 611HT, 821FR, 836, 837BM*, 837PU*, 846
Column V:	304, 774, 804, F42
Column VI:	830M, 838M

Note: * See Numeral 15

Caution: The fluid manufacturer's recommended maximum operating temperature for any specific name-brand fluid should be closely observed by the user. Specific name brand fluids can vary greatly between manufacturers even though they are considered to be from the same family of fluids. Using fluids above the manufacturer's maximum recommended temperature can cause the fluid to break down, creating by-products that can be harmful to elastomers or other materials used in the system. When selecting a hose type, both the fluid manufacturer and hose manufacturer's maximum temperature limit must be taken into consideration, with the lower of the two taking precedence.

Medium	I	II	III	IV	V	VI	STEEL	BRASS	SS
3M FC-75	A	A	A	A 15	A	A	A	A	A
A									
Acetic Acid	X	X	X	A 15	6	X	X	X	A
Acetone	X	X	X	A 15	A	X	A	A	A
Acetylene	X	X	X	X	X	-	-	-	-
AEROSHELL Turbine Oil 500 (See MIL-L-23699)	X	X	F	X	X	-	A	A	A
Agip Arnica 46	A	A	A	A	X	A			
Agip synth 2000	A	A	A	A	X	A			
Air	A, 1, 10	A, 1, 10	A, 1, 10	A 1, 10	A, 1, 10	A	A	A	A
Air (dry)	X	F, 1, 10	F, 1, 10	A 1, 10	A, 1, 10	A	A	A	A
AEROSHELL Fluid 41	-	F	A	-	-	-			
Alusol M	-	A	A	-	-	-			
Alcohol (Methanol-Ethanol)	F	F	F	A 15	F	-	F	A	A
Ammonia (Anhydrous)	X	X	X	X	X	-	X	X	X
Ammonium Chloride	A	A	A	A 15	A	A	X	X	X
Ammonium Hydroxide	F	F	F	A 15	A	X	F	X	A
Ammonium Nitrate	A	A	A	A 15	A	-	F	X	A
Ammonium Phosphate	A	A	A	A 15	A	-	X	X	F
Ammonium Sulfate	A	A	A	A 15	A	-	F	X	F
Ambra Multi G (NH 410 B)	-	A	A	-	-	-			
Amoco 32 Rykon	X	A	A	F 14	X	A	A	A	A
Ampol PE 46	X	X	X	X	A, 7	F	A	A	A
AMSOIL Synthetic ATF	F	A	A	A 15	X	F	A	A	A
Amyl Alcohol	X	X	X	A 15	F	-	X	A	A
Anderol 495,497,500,750	X	X	F	A 15	X	X	A	A	A
Aniline	X	X	X	A 15	A	X	A	X	A
Animal Fats	X	F	F	A 15	F	-	6	6	A
Aquacent Light, Heavy	X	A	A	X	X	A	A	A	A
Aral Vitam HF46	A	A	A	X	X	F			
Argon	A	A	A	A	A	A	A	A	A
Aromatic 100,150	X	F	F	-	X	F	A	A	A
Arrow 602P	A	A	A	A 14	X	A	A	A	A
Asphalt	X	F	F	F 14	X	A	F	F	A
ASTM #3 Oil	F	F	F	A 15	X	-	A	A	A
ATF-M	F	A	A	A 14	X	A	A	A	A
Avantin 361	-	A	A	-	-	-			
Avia Syntofluid PE B50	A	A	A	-	-	-			
Avialith 2 WC	-	A	A	-	-	-			
Automotive Brake Fluid	X	X	X	X	-	X	X	X	X
AW 32,46,68	F	A	A	A 14	X	A	A	A	A
B									
BCF	F	F	F	F 15	-	-	A	A	A
Benz Petraulic 32,46,68,100,150,220,320,460	F	A	A	A 14	X	A	A	A	A
Benzene, Benzol	X	X	X	A 15	X	F	A	A	A
Benzgrind HP 15	-	A	A	A 15	X	-	A	A	A
Benzine	X	X	X	F 15	X	-	A	A	A
Biodegradable Hydraulic Fluid 112B	X	A	A	X	-	-	A	A	A
Biodiesel E20	X	F	X	X	X	X	-	-	-
Biodiesel E100	X	F	X	X	X	X	-	-	-
Biodiesel E60	X	F	X	X	X	X	-	-	-
Biodiesel E80	X	F	X	X	X	X	-	-	-
Borax	F	F	F	A 15	A	-	F	A	A
Boric Acid	A	A	A	X	A	X	X	6	A
Brayco 882	X	A	A	A 15	X	-	A	A	A
Brayco Micronic 745	X	X	A	F 14	X	A	A	A	A
Brayco Micronic 776RP	F	A	A	F 14	X	A	A	A	A
Brayco Micronic 889	X	F	F	-	X	-	A	A	A
Brine	F	F	F	A 15	A	-	X	F	F

Medium	I	II	III	IV	V	VI	STEEL	BRASS	SS
Butane		See 2 & 13				F	A	A	A
Butyl Alcohol, Butanol	F	F	F	A 15	F	-	F	F	A
C									
Calcium Chloride	A	A	A	A 15	A	-	F	F	X
Calcium Hydroxide	A	A	A	A 15	A	-	A	A	A
Calcium Hypochlorite	X	X	X	A 15	A	-	X	F	X
Calibrating Fluid	A	A	A	A 14	X	A	A	A	A
Carbon Dioxide, gas	F	F	F	F 15	6	-	A	A	A
Carbon Disulfide	X	X	X	A 15	X	-	A	F	A
Carbon Monoxide (hot)	F	F	F	A 15	6	-	F	6	A
Carbon Tetrachloride	X	X	X	A 15	X	-	6	6	6
Carbonic Acid	F	F	F	X	F	X	X	X	F
Castor Oil	A	A	A	A 15	A	-	A	A	A
Castrol 5000	X	F	F	A 15	X	X	A	A	A
Castrol Wendax	-	A	A	-	-	-			
Cellosolve Acetate	X	X	X	X	A	-	X	X	A
Cellugard	A	A	A	-	A	-	A	A	A
Cellulube 90, 150, 220 300, 550, 1000	X	X	X	-	A	-	A	A	A
Chevron Clarity AW 32, 46, 68	A	A	A	A 14	X	A	A	A	A
Chevron FLO-COOL 180	F	F	F	-	X	-	A	A	A
Chevron FR-8, 10, 13, 20	X	X	X	X	A, 7	F	A	A	A
Chevron Hydraulic Oils AW MV 15, 32, 46, 68, 100	A	A	A	A 14	X	A	A	A	A
Chevron HyJet IV (9)	X	X	X	X	A, 7	F	A	A	A
Citric Acid	F	A	A	X	A	X	X	X	6
Commonwealth EDM 242, 244	A	A	A	-	X	A	A	A	A
CompAir CN300	X	X	X	A 15	X	X	A	A	A
CompAir CS100, 200, 300, 400	X	X	X	A 15	X	X	A	A	A
Condat D46 - D68	F	A	A	-	-	-			
Coolanol 15, 20, 25, 35, 45	A	A	A	A 15	A	X	A	A	A
Copper Chloride	F	A	A	X	A	-	X	X	X
Copper Sulfate	A	A	A	X	A	-	X	X	F
Cosmolubric HF-122, HF-130, HF-144	X	F	A	X	X	-	A	A	A
Cosmolubric HF-1530	X	F	A	X	X	-	A	A	A
Cottonseed Oil	F	A	A	F 15	X	-	A	A	A
CPI CP-4000	X	X	X	A 15	X	-	A	A	A
Crude Petroleum Oil	F	A	A	A 14	X	A	F	F	A
CSS 1001 Dairy Hydraulic Fluid	F	A	A	A 15	X	-	A	A	A
D									
Daphne AW32	A	A	A	A 14	X	A	A	A	A
Dasco FR 201-A	A	A	A	-	X	-	A	A	A
Dasco FR150, 200, 310	F	A	A	-	A	-	A	A	A
Dasco FR300, FR2550	X	X	X	-	X	F	A	A	A
Dasco FR355-3	X	F	A	X	X	X	A	A	A
Deicer Fluid 419R	A	A	A	-	-	A	A	A	A
Deionized Water	A	A	A	A 15	A	-	F	F	A
Dexron II ATF	F	A	A	A 14	X	A	A	A	A
Dexron III ATF	X	F, 11	F, 11	A 15, 12	X	-	A	A	A
Diesel Fuel	F, 3	A, 3	A, 3	A 15, 3	X	A(2)	A	A	A
Diester Fluids	X	X	X	X	X	X	A	A	A
Divinol HLP 46	-	A	A	-	-	-			
DOT III-IV	X	X	X	X	F	-			
Dow Corning 2-1802 Sullair (24KT)	-	-	-	F 15	-	-	A	A	A
Dow Corning DC 200, 510, 550, 560, FC126	A	A	A	A 15	-	-	A	A	A
Dow HD50-4	F	F	F	-	-	-	-	-	A
Dow Sullube 32	-	-	-	F 15	-	-	A	A	A
Dowtherm A,E	X	X	X	A 15	X	-	A	A	A
Dowtherm G	X	X	X	X	X	-	A	A	A
Duro AW-16, 31	A	A	A	-	X	-	A	A	A

Medium	I	II	III	IV	V	VI	STEEL	BRASS	SS
Duro FR-HD	A	A	A	-	X	-	A	A	A
E									
EcoSafe FR-68	A	A	A	-	X	X	A	A	A
Ethanol	F	F	F	A 15	F	-	F	A	A
Ethers	X	X	X	A 15	X	-	A	A	A
Ethyl Acetate	X	X	X	A 15	F	-	F	A	A
Ethyl Alcohol	F	F	F	A 15	F	-	F	A	A
Ethyl Cellulose	F	F	F	A 15	F	-	X	F	F
Ethyl Chloride	X	X	X	X	A	-	F	F	F
Ethylene Dichloride	X	X	X	A 15	X	-	X	A	X
Ethylene Glycol	F	A	A	A	A	A	A	F	A
Exxon 3110 FR	A	A	A	A 15	X	A	A	A	A
Exxon Esstic	A	A	A	A 14	A	A	A	A	A
Exxon Nuto H 46, 68	A	A	A	A 14	X	A	A	A	A
Exxon Tellura Industrial Process Oils	A	A	A	A 14	X	A	A	A	A
Exxon Terresstic, EP	A	A	A	A 14	A	A	A	A	A
Exxon Turbo Oil 2380	X	F	F	A 15	X	X	A	A	A
Exxon Univolt 60, N61	F	A	A	A 14	X	A	A	A	A
F									
FE 232 (Halon)	X	X	X	X	F	-	A	A	A
Fenso 150	-	A	A	-	X	A	A	A	A
Formaldehyde	X	X	X	A 15	A	-	X	F	A
Formic Acid	X	X	X	X	A	X	X	6	X
Freons see refrigerants	-	-	-	-	-	-	-	-	-
Fuel Oil	F, 3	A, 3	A, 3	A 15, 3	X	A(2)	A	A	A
Fyre-Safe 120C, 126, 155, 1090E, 1150, 1220, 1300E	X	X	X	X	A, 7	F	A	A	A
Fyre-Safe 200C, 225, 211	F	A	A	A	A	F	A	A	A
Fyre-Safe W/O	A	A	A	A 15	X	A	A	A	A
Fyrguard 150, 150-M, 200	A	A	A	A	A	F	A	A	A
Fyrquel 60, 90, 150, 220, 300, 550, 1000	X	X	X	X	A, 7	F	A	A	A
Fyrquel EHC, GT, LT, VPF	X	X	X	X	A, 7	F	A	A	A
Fyrtek MF, 215, 290, 295	X	X	X	X	X	F	A	A	A
G									
Gardner-Denver GD5000, GD8000	X	X	X	A 15	X	X	A	A	A
Gasoline		See 9				-	A	A	A
Glue	F	F	F	-	X	-	A	F	A
Glycerine, Glycerol	A	A	A	A 15	A	-	A	F	A
Grease	A	A	A	A 14	X	A	A	A	A
Gulf-FR Fluid P37, P40, P43, P45, P47	X	X	X	A 15	A	-	A	A	A
H									
H-515 (NATO)	A	A	A	-	X	-	A	A	A
Halon 1211, 1301	F	F	F	F 15	-	-	A	A	A
Helium Gas	X	X	X	X	X	-	A	A	A
Heptane	X	F	F	A 15	X	-	A	A	A
Hexane	X	F	F	A 15	X	-	A	A	A
HF-20, HF-28		A	A	A	A	F	A	A	A
Houghto-Safe 1055, 1110, 1115, 1120, 1130 (9)	X	X	X	X	A, 7	F	A	A	A
Houghto-Safe 271 to 640	F	A	A	A	A	F	A	A	A
Houghto-Safe 419 Hydraulic Fluid	A	A	A	-	X	-	A	A	A
Houghto-Safe 419R Deicer Fluid	A	A	A	-	-	A	A	A	A
Houghto-Safe 5046, 5046W, 5047-F	A	A	A	A 15	X	-	A	A	A
HP 100C (Jack hammer oil)	F	A	A	A 14	X	A	A	A	A
HPWG 46B	F	A	A	A	-	F	A	A	A
Hul-E-Mul	A	A	A	-	X	-	A	A	A
Hychem C, EP1000, RDF	A	A	A	A 15	A	-	A	A	A
Hycut SE 12	F	A	A	-	-	-			
Hycut SE 46	F	A	A	-	-	-			
Hydra Safe E-190	A	A	A	A 15	X	-	A	A	A

Medium	I	II	III	IV	V	VI	STEEL	BRASS	SS
Hydra-Cut 481, 496	A	A	A	-	X	-	A	A	A
Hydrafluid 760	A	A	A	-	X	-	A	A	A
Hydrochloric Acid	X	X	X	X	X	X	X	X	X
Hydrofluoric Acid	X	X	X	X	X	X	X	6	X
Hydrogen Gas	X	X	X	X	X	-	A	A	A
Hydrogen Peroxide	X	X	X	A 15	X	-	X	X	6
Hydrogen Sulfide	X	X	X	X	A	-	X	X	6
Hydrolube	A	A	A	A 15	A	-	A	A	A
Hydrolubric 120-B, 141, 595	F	A	A	A 15	A	-	A	A	A
Hydrosafe Glycol 200	A	A	A	A	A	F	A	F	A
Hydrovane Fluid Force 2000	-	A	A	-	-	-			
HyJet IV	X	X	X	X	A, 7	-	A	A	A
HT BRADOL (Virto)	-	A	A	-	-	-			
I									
Ideal Yellow 77	A	A	A	A 15	X	-	A	A	A
Imol S150 to S550	X	X	X	-	-	-	A	A	A
Ingersoll Rand SSR Coolant	X	X	X	A 15	X	X	A	A	A
Isocyanates	X	X	X	A 15	X	-	A	-	A
Isooctane	X	F	F	A 15	X	-	A	A	A
Isopar H	X	X	X	X	X	-	A	A	A
Isopropyl Alcohol	F	F	F	A 15	F	-	F	A	A
J									
Jayflex DIDP	X	X	X	X	A	-	A	A	A
JP3 and JP4	X	A,3	A,3	-	X	A(2)	A	A	A
JP5	X	A,3	A,3	F 15,3	X	A(2)	A	A	A
JP9	X	X	X	X	X	-	A	-	A
K									
Kaeser 150P, 175P, 325R, 687R	X	X	X	A 15	X	-	A	A	A
Kerosene	X	A	A	F 14	X	A	A	A	A
KSL-214, 219, 220, 222	X	X	X	A 15	X	-	A	A	A
L									
Lacquer	X	X	X	A 15	X	-	X	A	A
Lacquer Solvents	X	X	X	A 15	X	-	X	A	A
Lactic Acids	X	X	X	X	X	X	X	X	A
Lindol HF	X	X	X	A 15	A	-	A	A	A
Linseed Oil	F	A	A	A 15	A	-	A	A	A
LP-Gas		See 13				-	A	A	A
M									
Magnesium Chloride	A	A	A	A 15	A	-	X	X	X
Magnesium Hydroxide	F	F	F	A 15	A	-	F	F	F
Magnesium Sulfate	A	A	A	A 15	A	-	A	F	A
Mercaptans	X	X	X	X	X	-	-	-	-
Methane		See 13				-	A	A	A
Methanol	A	F	A	A 15	F	-	F	A	A
Methyl Alcohol	A	F	A	A 15	F	-	F	A	A
Methyl Chloride	X	X	X	A 15	X	-	A	A	A
Methyl Ethyl Ketone (MEK)	X	X	X	A 15	X	-	F	A	A
Methyl Isopropyl-Ketone	X	X	X	X	X	-	F	A	A
Metsafe FR303, FR310, FR315, FR330, FR350	X	X	X	X	X	F	A	A	A
Microzol-T46	X	A	A	-	X	-	A	A	A
MIL-H-544	-	A	A	-	-	-			
MIL-B-46176A	X	X	X	X	X	-	X	X	X
MIL-H-46170	X	F	F	A 15	X	-	A	A	A
MIL-H-5606	F	A	A	A 14	X	A	A	A	A
MIL-H-6083	F	A	A	A 15	X	-	A	A	A
MIL-H-7083	F	A	A	A 15	X	-	A	A	A
MIL-H-83282	F	A	A	A 15	X	-	A	A	A
MIL-L-2104, 2104B	F	A	A	A 14	X	A	A	A	A

Medium	I	II	III	IV	V	VI	STEEL	BRASS	SS
MIL-L-23699	X	X	X	X	X	X	A	A	A
MIL-L-7808	F	A	A	-	X	-	A	A	A
Mine Guard FR	A	A	A	-	A	-	A	A	A
Mineral Oil	A	A	A	F 14	X	A	A	A	A
Mineral Spirits	8	8	8	8	X	-	A	A	A
Mobil Aero HF	-	A	A	-	-	-			
Mobil Aero HFE	F	A	A	F 14	X	A	A	A	A
Mobil ATF 220	-	A	A	-	-	-			
Mobil DTE 11M, 13M, 15M, 16M, 18M, 19M	F	A	A	A 14	X	A	A	A	A
Mobil DTE 22, 24, 25, 26	F	A	A	A 14	X	A	A	A	A
Mobil EAL 224H	X	A	A	X	-	-	A	A	A
Mobil EAL Artic 10, 15, 22,32, 46, 68, 100	X	X	X	X	X	X	A	A	A
Mobil Glygoyle 11, 22, 30, 80	X	F	F	-	X	-	A	A	A
Mobil HFA	F	A	A	A 15	X	-	A	A	A
Mobil Jet 2	X	F	F	A 15	X	-	A	A	A
Mobil Nyvac 20, 30, 200, FR	F	A	A	A	A	F	A	A	A
Mobil Rarus 824, 826, 827	X	X	X	A 15	X	X	A	A	A
Mobil SHC 524	-	A	A	-	-	-			
Mobil SHC 600 Series	F	A	A	A 15	X	-	A	A	A
Mobil SHC 800 Series	F	A	A	A 15	X	-	A	A	A
Mobil Vactra Oil	A	A	A	F 14	X	A	A	A	A
Mobil XRL 1618B	X	X	X	X	A, 7	F	A	A	A
Mobilfluid 423	F	A	A	A 14	X	A	A	A	A
Mobilgear SHC 150, 220, 320, 460, 680	F	F	F	A 15	X	-	A	A	A
Mobilarma 525	A	A	A	F 14	X	A	A	A	A
Molub-Alloy 890	X	X	X	A 15	X	-	A	A	A
Moly Lube "HF" 902	F	F	F	F 14	X	A	A	A	A
Monolec 6120 Hydraulic Oil	A	A	A	A 14	X	A	A	A	A
Morpholine (pure additive)	X	X	X	X	X	-	X	X	A
Motorex Corex HLP 46	A	A	A	-	-	-			
N									
Naptha	F	F	A	A 15	X	-	A	A	A
Napthalene	X	X	X	A 15	X	-	A	A	A
Natural Gas		See 13				-	A	A	A
Nitric Acid	X	X	X	X	X	X	X	X	F
Nitrobenzene	X	X	X	A 15	X	-	X	X	A
Neste SE 46	F	A	A	-	-	-			
Neste 46 32	A	A	A	-	-	-			
Nitrogen, gas	F, 1	F, 1	F, 1	F 15, 1	F, 1	-	A	A	A
NORPAR 12, 13, 15	8	8	8	8	X	-	A	A	A
Nuto H 46, 68	A	A	A	A 14	X	A	A	A	A
Nyvac 20, 30, 200, FR	F	A	A	A	A	F	A	A	A
Nyvac Light	X	X	X	-	A	-	A	A	A
O									
Oceanic HW	F	A	A	A	X	F	A	A	A
Oxygen, gas	A	X	X	X	X	-	X	A	A
Ozone	F	X	F	F	A	A	A	A	A
P									
Pacer SLC 150, 300, 500, 700	X	X	X	A 15	X	-	A	A	A
Panolin HLP 46	F	A	A	-	-	-			
Panolin TURWANDA SYNTH 46	F	A	A	-	-	-			
Pennzbell AWX	F	A	A	F 14	X	A	A	A	A
PENTOSIN CHF 11S	F	A	A	F	A	X	A	A	A
Perchloroethylene	X	X	X	X	X	-	F	X	A
Petroleum Ether	X	F	F	F 14	X	A	A	A	A
Petroleum Oils	A	A	A	A 14	X	A	A	A	A
Phenol (Carbolic Acid)	X	X	X	A 15	X	X	X	F	A
Phosphate Ester Blends	X	X	X	X	X	F	A	A	A

Technical handbook

Medium	I	II	III	IV	V	VI	STEEL	BRASS	SS
Phosphate Esters	X	X	X	X	A, 7	-	A	A	A
Phosphoric Acid 10 %	F	X	X	X	A	X	X	X	F
Plantosin HVI 46	-	A	A	-	-	-			
Plexus 46	F	A	A	-	-	-			
Polyalkylene Glycol	A	F	F	-	X	-	A	A	A
Polyol Ester	X	F	A	X	X	-	A	A	A
Potassium Chloride	A	A	A	A 15	A	-	X	F	F
Potassium Hydroxide	X	X	X	A 15	A	-	6	X	A
Potassium Sulfate	A	A	A	A 15	A	-	A	A	A
Propane		See 13				-	A	A	A
Propylene Glycol	A	A	A	A 15	A	-	F	F	F
Pydraul 10-E, 29-E, 50-E, 65-E, 90-E, 115-E	X	X	X	X	A, 7	F	A	A	A
Pydraul 230-C, 312-C, 68-S	X	X	X	X	A, 7	F	A	A	A
Pydraul 60, 150, 625, F9	X	X	X	X	A, 7	-	A	A	A
Pydraul 90, 135, 230, 312, 540, MC	X	X	X	X	X	-	A	A	A
Pydraul A-200	X	X	X	A 15	X	-	A	A	A
Pyro Gard 43, 230, 630	X	X	X	X	X	-	A	A	A
Pyro Gard C, D, R, 40S, 40W	F	A	A	F 15	X	A	A	A	A
Pyro Guard 53, 55, 51, 42	X	X	X	X	A, 7	-	A	A	A
Q									
Q8 Holbein Bio Plus	F	A	A	-	-	-			
Quintolubric 700	A	A	A	A 15	A	-	A	F	A
Quintolubric 807-SN	F	A	A	-	X	-	A	A	A
Quintolubric 822, 855	X	F, 5	A, 5	X	X	X	A	A	A
Quintolubric 888	X	A, 5	A, 5	X	X	-	A	A	A
R									
Rando	A	A	A	A 14	X	A	A	A	A
Rando HD 46	-	A	A	-	-	-			
Rayco 782	X	F	A	X	X	-	X	X	X
Renault ST 46M	A	A	A	-	-	-			
Renolin Lift	-	A	A	-	-	-			
Renolin HVI 46	-	A	A	-	-	-			
Refrigerant 124		See 4				X	A	A	A
Refrigerant Freon 113, 114	X	X	X	X	X	X	A	A	A
Refrigerant Freon 12		See 4				X	A	A	A
Refrigerant Freon 22		See 4				X	A	A	A
Refrigerant Freon 502		See 4				X	A	A	A
Refrigerant HFC134A		See 4				X	A	A	A
Reolube Turbofluid 46	X	X	X	X	A, 7	-	A	A	A
Rivolta B.H.23	F	A	A	-	-	-			
Rotella	A	A	A	A 14	X	A	A	A	A
Royal Bio Guard 3032, 3046, 3068, 3100	X	~	A	X	X	X	A	A	A
Royco 2200, 2210, 2222, 2232, 2246, 2268	X	X	X	X	X	X	A	A	A
Royco 4032, 4068, 4100, 4150	X	X	X	A 15	X	X	A	A	A
Royco 756, 783	A	A	A	A 14	X	A	A	A	A
Royco 770	X	F	F	F 15	X	-	A	A	A
RTV Silicone Adhesive Sealants	X	X	X	X	X	-	A	A	A
S									
Safco-Safe T10, T20	-	-	-	-	A	-	F	F	A
Safety-Kleen ISO 32, 46, 68 hydraulic oil	F	A	A	-	X	A	A	A	A
Safety-Kleen Solvent	8	8	8		X	8	A	A	A
Santoflex 13	F	F	F	-	F	-	A	A	A
Santosafe 300	X	X	X	-	X	-	A	A	A
Santosafe W/G 15 to 30	-	-	-	A 15	A	-	A	A	A
Sea Water	A	F	F	A 15	A	A	X	F	A
Sewage	F	F	F	A 15	F	-	X	F	A
Shell 140 Solvent	8	8	8	8	X	-	A	A	A
Shell Clavus HFC 68	X	X	X	X	X	X	A	A	A

Medium	I	II	III	IV	V	VI	STEEL	BRASS	SS
Shell Comptella Oil	F	F	F	A 14	X	A	A	A	A
Shell Comptella Oil S 46, 68	F	F	F	A 14	X	A	A	A	A
Shell Comptella Oil SM	F	F	F	A 14	X	A	A	A	A
Shell Diala A, (R) Oil AX	F	A	A	F 14	X	A	A	A	A
Shell FRM	-	-	-	-	X	-	A	A	A
Shell IRUS 902, 905	A	A	A	-	A	-	A	A	A
Shell IRUS Fluid DU 46	F	A	A	-	-	-			
Shell Naturelle HF-E	F	A	A	F	X	F14	A	A	A
Shell Pella-A	A	A	A	A 15	X	-	A	A	A
Shell Tellus	F	A	A	A 14	X	A	A	A	A
Shell Tellus TD 46	A	A	A	A	A	X	A	A	A
Shell Thermia Oil C	A	A	A	A 14	X	A	A	A	A
Shell Turbo R	X	F	F	A 15	X	X	A	A	A
SHF 220, 300, 450	X	X	A	X	X	X	A	A	A
Silicate Esters	A	F	F	A 15	X	-	A	A	A
Silicone Oils	A	A	A	-	-	-	A	A	A
Silicone Sealants	X	X	X	X	X	-	A	A	A
Skydrol 500B-4, LD-4	X	X	X	X	A, 7	F	A	A	A
Soap Solutions	E	F	F	F 15	A	A	A	A	A
Soda Ash, Sodium Carbonate	A	A	A	A 15	A	-	A	F	A
Sodium Bisulfate	F	X	X	A 15	A	-	F	A	F
Sodium Chloride	A	F	F	A 15	A	-	X	F	A
Sodium Hydroxide	A	X	X	A 15	A	-	A	X	A
Sodium Hypochlorite	A	X	X	X	A	X	X	X	X
Sodium Nitrate	A	F	F	A 15	A	A	A	F	A
Sodium Peroxide	F	X	X	X	A	X	X	X	A
Sodium Silicate	A	A	A	A 15	A	-	A	A	A
Sodium Sulfate	A	A	A	A 15	A	-	A	A	A
Soybean Oil	F	A	A	A 15	X	-	A	A	A
SSR Coolant	X	X	X	A 15	X	X	A	A	A
Steam	X	X	X	X	X	-	F	A	A
Stoddard Solvent	8	8	8	8	X	8	A	A	A
Sulfur Chloride	X	X	X	F	X	-	X	X	X
Sulfur Dioxide	X	X	X	X	F	-	X	F	F
Sulfur Trioxide	X	X	X	F	F	-	X	X	X
Sulfuric Acid (0% to 30% room temperture)	F, 6	F, 6	F, 6	X	F, 6	-	6	X	6
Summa-20, Rotor, Recip	X	X	X	F	X	-	A	A	A
Summit DSL-32,68,100,125	X	X	X	F	X	-	A	A	A
Sun Minesafe, Sun Safe	X	F	F	F	X	-	A	A	A
Sundex 8125	X	F	F	-	X	-	A	A	A
Suniso 3GS	A	A	A	A 14	X	A	A	A	A
Sun-Vis 722	X	F	F	-	X	-	A	A	A
Super Hydraulic Oil 100, 150, 220	A	A	A	A 14	X	A	A	A	A
SUVA MP 39, 52, 66	X	X	X	X	X	X	A	A	A
SYNCON Oil	X	X	X	X	X	-	A	A	A
Syndale 2820	X	F	F	-	-	-	A	A	A
Synesstic 32,68,100	X	X	X	X	X	X	A	A	A
Syn-Flo 70,90	X	X	X	X	X	-	A	A	A
SYN-O-AD 8478	X	X	X	X	A, 7	F	A	A	A
T									
Tannic Acid	F	A	A	F	A	X	X	F	X
Tar	F	F	F	F	X	-	X	F	A
Tellus (Shell)	F	A	A	A 14	X	F	A	A	A
Texaco 760 Hydrafluid	-	-	-	-	X	-	A	A	A
Texaco 766, 763 (200 - 300)	-	-	-	-	A	-	F	F	A
Texaco A-Z Oil	A	A	A	F 14	X	A	A	A	A
Texaco Spindura Oil 22	F	F	F	F 14	X	A	A	A	A
Texaco Way Lubricant 68	A	A	A	A 14	X	A	A	A	A

Medium	I	II	III	IV	V	VI	STEEL	BRASS	SS
Thanol-R-650-X	X	F	F	-	X	-	A	A	A
Thermanol 60	X	X	X	X	X	-	A	A	A
Toluene, Toluol	X	X	X	X	X	-	A	A	A
Transmission Oil	A	A	A	A 14	X	A	A	A	A
Tribol 1440	X	X	X	X	A	F	A	A	A
Trichloroethylene	X	X	X	F	X	-	X	A	A
Trim-Sol	F	A	A	F	X	-	A	A	A
Turbinol 50, 1122, 1223	X	X	X	X	A, 7	-	A	A	A
Turpentine	X	X	X	F	X	-	A	A	A
U									
Ucon Hydrolubes	F	A	A	A	A	F	A	A	A
UltraChem 215,230,501,751	X	X	X	A 15	X	-	A	A	A
Univis J26	A	A	A	A 14	X	A	A	A	A
Unleaded Gasoline		See 9				-	A	A	A
Unocal 66/3 Mineral Spirits	8	8	8	8	X	-	A	A	A
Urea	F	F	F	A 15	F	-	F	-	F
Urethane Formulations	A	A	A	A 15	-	-	A	A	A
V									
Van Straaten 902	A	A	A	A 15	X	-	A	A	A
Varnish	X	X	X	F	X	-	F	F	A
Varsol	8	F	F	8	X	-	A	A	A
Versilube F44, F55	-	A	A	A 15	-	-	A	A	A
Vinegar	X	X	X	A 15	A	-	F	X	A
Vital 29, 4300, 5230, 5310	X	X	X	X	X	-	A	A	A
Volt Esso 35	A	A	A	A 15	X	-	A	A	A
W									
Water	A	A	A	A	A	A	F	A	A
Water / Glycols	A	A	A	A	A	F	A	F	A
X									
Xylene, Xylol	X	X	X	X	X	-	A	A	A
Z									
Zerol 150	A	A	A	A 14	X	A	A	A	A
Zinc Chloride	A	A	A	X	A	-	X	X	F
Zinc Sulfate	A	A	A	X	A	-	X	A	A



Hydraulic Hoses and Fittings

Low Pressure



ENGINEERING YOUR SUCCESS.

Push-Lok®

The self-grip hose system for low-pressure applications

Parker's Push-Lok hose line features the widest fluid compatibility, application and size range in the industry. The Push-Lok system is easy to use. No clamps or special tools are required during installation. And with Parker's exclusive color-code system, you can inventory, maintain and identify your hose needs easily and efficiently. The industry's most complete line of low-pressure hose and fittings, Push-Lok offers the range and versatility to meet all your instrumentation needs.

One fitting series for all hose types with a wide range of end-configurations

DIN, BSP, SAE, JIC and ORFS connections in

- brass
- steel
- stainless steel



Wide range of hose types

7 x rubber

- 801PLUS** for a variety of applications
- 801RH** for train vehicles
- 804** for high-temperature water/phosphate ester fluids
- 821FR** with fire-retardant hose cover
- 836, 846** for high oil temperatures
- 837BM** for a variety of applications including automotive

2 x thermoplastic

- 830M** for a variety of applications including automotive
- 838M** for non-conductive applications

1 x hybrid

- 837PU-PLUS** for a variety of high demanding applications including automotive

Wide range of applications



The outstanding properties

- Easy assembly and organisation with Parker's exclusive color-code system
- Push-Lok assemblies can be made in seconds, saving valuable time and cost
- The unique seal of Push-Lok ensures reliable, durable, leak-free service
- High functional safety with a design factor of 4
- Wide range of hose and fittings for a wide range of applications

Exclusive color-code system

6 different colours

In applications where a number of hose lines carry different media, Push-Lok colors reduce timely "tracing" of lines, preventing disconnection of wrong line and unnecessary, downtime.

Using color-coded Push-Lok hose is an excellent way to:

- Enhance product appearance
- Improve inventory control
- Identify industrial drop lines
- Easy control of maintenance intervals
- Simple stock planning in different departments



Hose construction and hose-fitting connection

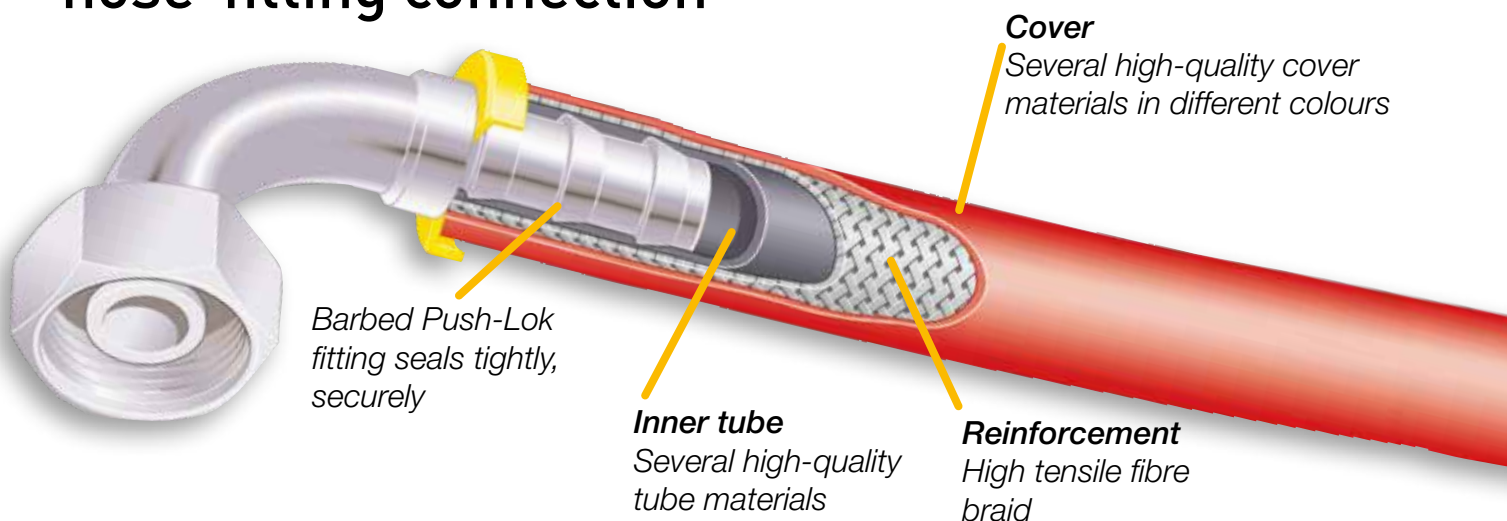

Low Pressure Push-Lok

Hoses		Page
801Plus	Multipurpose	B1a-1
801RH	Railway	B1a-2
804	Phosphate Ester	B1a-3
821FR	Fire retardant	B1a-4
830M	Multipurpose	B1a-5
836	High temperature	B1a-6
837BM	Multipurpose	B1a-7
837PU	Multipurpose	B1a-8
838M	Non-conductive	B1a-9
846	High temperature	B1a-10

Fittings Series	82
Chapter	B1b
DIN – Metric	1 – 7
BSP	8 – 10
SAE	11 – 14
ORFS	15
Others	16 – 18
Assembly Instructions / Tools	19

Parker Hannifin assumes no liability for typographical errors or other errors

Multipurpose

801PLUS

B1a-1



Push-Lok Plus
For a variety of applications

830M

B1a-5



Push-Lok
For a variety of applications
including automotive

837BM

B1a-7



Push-Lok
For a variety of applications
including automotive

837PU-Plus

B1a-8



Hybrid Push-Lok
For a variety of high demanding applications

Railway

801RH

B1a-2



Push-Lok
Fire retardant cover

Phosphate Ester

804

B1a-3



Push-Lok
For high temperature
water and phosphate ester fluid

High temperature

836

B1a-6



Push-Lok
For high oil temperatures

846

B1a-10



Push-Lok
For high oil temperatures

Fire retardant

821FR

B1a-4



Push-Lok
With fire retardant hose cover

Non-conductive

838M

B1a-9



Push-Lok
For non-conductive applications

801PLUS

Push-Lok Plus

For a variety of applications

Primary Applications

All Markets: For low pressure applications
Paper and Pulp: For water / air applications

Restrictions

Not permitted for use in air brake systems, high dynamic pulsation systems and with dry air.
Not recommended for fuels.

Construction

Inner tube: Nitrile (NBR)
Reinforcement: High-tensile fibre braid
Cover: High performance synthetic rubber in different colours

Temperature Range -40 °C up to +100 °C

Exception: Air max. +70 °C
Water max. +85 °C



- Global availability and performance
- Very flexible
- Available in 6 colours
- Available up to size -16
- Nitrile (NBR) inner tube – extended fluid compatibility
- Improved oil compatibility

Recommended Fluids

Air, water, water-oil emulsions, water-glycol and mineral based hydraulic respectively lubricating oils.
Consult the chemical compatibility section pages **Ab-26** to **Ab-34** for more detailed information.

Fitting Series



Part Number	Hose I.D.				Hose O.D. mm	Pressure Rating				Vacuum* kPa	min. bend radius mm	weight kg
	DN	Inch	Size	mm		max. working pressure		min. burst pressure				
						MPa	psi	MPa	psi			
801PLUS-4-XXX-RL	6	1/4	-4	6.4	12.7	2.4	350	9.7	1400	95	65	0.13
801PLUS-6-XXX-RL	10	3/8	-6	9.5	15.9	2.4	350	9.7	1400	95	75	0.16
801PLUS-8-XXX-RL	12	1/2	-8	12.7	19.8	2.1	300	8.4	1200	95	125	0.27
801PLUS-10-XXX-RL	16	5/8	-10	15.9	23.0	2.1	300	8.4	1200	51	150	0.28
801PLUS-12-XXX-RL	19	3/4	-12	19.1	26.2	2.1	300	8.4	1200	51	180	0.36
801PLUS-16-XXX-RL	25	1	-16	25.4	32.5	1.4	200	5.6	800	51	250	0.55

* The vacuum values listed in the table are vacuum pressure values in kPa. For an absolute value subtract the table value from 101 kPa

Note: When ordering, please replace in the part number XXX with the relevant colour code. Example: 801PLUS-4-BLU-RL

For 801PLUS in yellow (YEL) only, please consider the part-number without PLUS. Example: 801-4-YEL-RL

Colour codes

BLK = black
BLU = blue
RED = red
GRN = green
GRA = grey
YEL = yellow



RL = only available on reels

Hose layline example

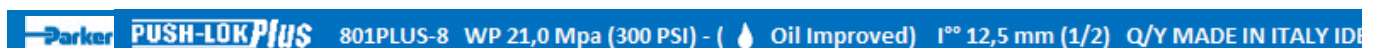

801RH

Push-Lok

Fire retardant cover

Primary Applications

For low pressure railway applications

Restrictions

Not permitted for use in air brake systems.
Not suitable for high dynamic pulsation systems.
Not recommended for fuels (petrol, diesel etc.).
Not recommended for mineral based hydraulic and lubricating oils.

Construction

Tube: Synthetic rubber
Reinforcement: High-tensile fibre braid
Cover: Fire retardant synthetic rubber

Temperature Range -40 °C up to +100 °C

Exception: Air max. +70 °C
Water max. +85 °C



- Very flexible
- Railway approved:
 - European Standard EN45545 HL2 for R22 (internal) and R23 (external)

Recommended Fluids

Air, water, water-oil-emulsions and water-glycol-emulsions.
Consult the chemical compatibility section on pages **Ab-26** to **Ab-34** for more detailed information.

Fitting Series



Part Number	Hose I.D.				Hose O.D. mm	Pressure Rating				Vacuum* kPa	min. bend radius mm	weight kg
	DN	Inch	Size	mm		max. working pressure MPa	psi	min. burst pressure MPa	psi			
801RH-4-BLK-RL	6	1/4	-4	6.4	12.7	2.4	350	9.7	1400	95	65	0.13
801RH-6-BLK-RL	10	3/8	-6	9.5	15.9	2.4	350	9.7	1400	95	75	0.16

* The vacuum values listed in the table are vacuum pressure values in kPa. For an absolute value subtract the table value from 101 kPa

Colour code

BLK = black



The hose is available in black only

RL = only available on reels

Hose layline example

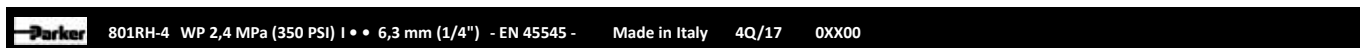

804

Push-Lok

For high temperature water and phosphate ester fluid

Primary Applications

Injection Moulding: For special tempering circuits.

Restrictions

Not permitted for use in air brake systems and high dynamic pulsation systems.

Do not allow tube to contact any petroleum based fluids.

Construction

Inner tube: EPDM synthetic rubber
Reinforcement: High-tensile fibre braid
Cover: EPDM synthetic rubber , black

Temperature Range -40 °C up to +80 °C

Exception: Air max. +70 °C

Water max. +93 °C



- For hot water up to +93 °C
- For phosphate ester fluids

Recommended Fluids

Phosphate ester based hydraulic fluids, water, water glycol emulsions, air. Use liquid soap as lubricant. Consult the chemical compatibility section pages **Ab-26** to **Ab-34** for more detailed information.

Fitting Series



Part Number	Hose I.D.				Hose O.D. mm	Pressure Rating				Vacuum* kPa	min. bend radius mm	weight kg
	DN	Inch	Size	mm		max. working pressure		min. burst pressure				
						MPa	psi	MPa	psi			
804-4-RL	6	1/4	-4	6.4	12.7	1.0	150	4.0	600	51	65	0.13
804-6-RL	10	3/8	-6	9.5	15.9	1.0	150	4.0	600	51	75	0.16
804-8-RL	12	1/2	-8	12.7	19.8	1.0	150	4.0	600	51	130	0.27
804-10-RL	16	5/8	-10	15.9	23.0	1.0	150	4.0	600	51	150	0.28
804-12-RL	19	3/4	-12	19.1	26.2	1.0	150	4.0	600	51	180	0.36

RL = only available on reels

Cover color

Hose layline example

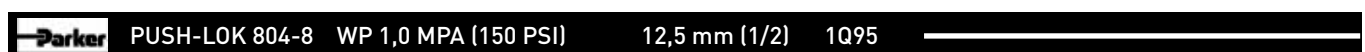

821FR

Push-Lok

With fire retardant hose cover

Primary Applications

All Markets: For a variety of applications

Restrictions

Not permitted for use in air brake systems and high dynamic pulsation systems.

Not recommended for fuels.

Construction

Inner tube: PKR synthetic rubber

Reinforcement: High-tensile fibre braid

Cover: A fire retardant special fiber outer cover in different colours

Temperature Range -40 °C up to +100 °C

Exception: Air max. +100 °C

Water max. +85 °C



- Fire retardant hose cover
- Very flexible
- For high level air temperatures

Recommended Fluids

Mineral based hydraulic and lubricating oils, coolant, antifreeze, air, water and water-oil emulsions.

Consult the chemical compatibility section pages

Ab-26 to **Ab-34** for more detailed information.

Fitting Series



Part Number	Hose I.D.				Hose O.D. mm	Pressure Rating				Vacuum* kPa	min. bend radius mm	weight kg
	DN	Inch	Size	mm		max. working pressure MPa	psi	min. burst pressure MPa	psi			
821FR-4-XXX-RL	6	1/4	-4	6.4	12.7	2.4	350	9.6	1400	95	65	0.12
821FR-6-XXX-RL	10	3/8	-6	9.5	15.9	2.1	300	8.4	1200	95	75	0.16
821FR-8-XXX-RL	12	1/2	-8	12.7	19.8	2.1	300	8.4	1200	95	130	0.18
821FR-12-XXX-RL	19	3/4	-12	19.1	26.2	1.7	250	6.8	1000	95	180	0.33

* The vacuum values listed in the table are vacuum pressure values in kPa. For an absolute value subtract the table value from 101 kPa
Note: When ordering, please replace in the part number XXX with the relevant colour code. Example: 821FR-4-GRN-RL

Colour codes

BLK = black
BLU = blue
GRN = green



RL = only available on reels

Hose layline example

PARKER PUSH-LOK 821FR-8 WP 2,0 MPa (300 PSI) 12,5 mm (1/2) 11-4Q85

830M

Push-Lok

For a variety of applications including automotive

Primary Applications

All Markets: For a variety of applications
Robot and Automotive market:
For hose bundle systems

Restrictions

Not permitted for use in air brake systems and high dynamic pulsation systems.
Not recommended for fuels.

Construction

Inner tube: Polyurethane material
Reinforcement: High-tensile fibre braid
Cover: High performance polyurethane material in different colours

Temperature Range -40 °C up to +80 °C



- Chemical resistant for a wide range of fluids
- High abrasion resistance
- Free of wetting disturbing substances (LABS free)
- Small OD and bend radii
- Excellent UV and ozone resistance

Recommended Fluids

Mineral based hydraulic and lubricating oils, coolant, antifreeze, air, water and water-oil emulsions.
Consult the chemical compatibility section pages **Ab-26** to **Ab-34** for more detailed information.

Fitting Series



Part Number	Hose I.D.				Hose O.D. mm	Pressure Rating				Vacuum* kPa	min. bend radius mm	weight kg
	DN	Inch	Size	mm		max. working pressure MPa	psi	min. burst pressure MPa	psi			
830M-4-XXX-RL	6	1/4	-4	6.4	10.7	1.6	232	6.4	928	10	30	0.08
830M-6-XXX-RL	10	3/8	-6	9.5	14.9	1.6	232	6.4	928	10	50	0.13
830M-8-XXX-RL	12	1/2	-8	12.7	19.1	1.6	232	6.4	928	10	70	0.20
830M-10-XXX-RL	16	5/8	-10	15.9	23.0	1.6	232	6.4	928	10	75	0.26
830M-12-XXX-RL	19	3/4	-12	19.1	26.0	1.6	232	6.4	928	10	110	0.31

* The vacuum values listed in the table are vacuum pressure values in kPa. For an absolute value subtract the table value from 101 kPa
Note: When ordering, please replace in the part number XXX with the relevant colour code. Example: 830M-4-GRN-RL

Colour codes

BLK = black
BLU = blue
RED = red
GRN = green



RL = only available on reels

Hose layline example

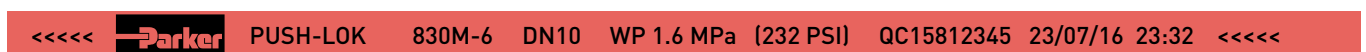

836

Push-Lok

For high oil temperatures

Primary Applications

All Markets: Special high temperature applications

Type Approvals

Details please find on pages **Ab-16** to **Ab-19**

Restrictions

Not permitted for use in air brake systems and high dynamic pulsation systems.

Not recommended for fuels.

Construction

Inner tube: PKR synthetic rubber

Reinforcement: High-tensile fibre braid

Cover: MSHA approved black or blue
PKR synthetic rubber

Temperature Range -48 °C up to +150 °C

Exception: Air max. +100 °C

Water max. +85 °C



- Max. oil temperature up to +150 °C
- MSHA approved

Recommended Fluids

Mineral based hydraulic and lubricating oils, coolant, antifreeze, air, water and water-oil emulsions.

Consult the chemical compatibility section pages **Ab-26** to **Ab-34** for more detailed information.

Fitting Series



Part Number	Hose I.D.				Hose O.D. mm	Pressure Rating				Vacuum* kPa	min. bend radius mm	weight kg
	DN	Inch	Size	mm		max. working pressure MPa	psi	min. burst pressure MPa	psi			
836-4-XXX-RL	6	1/4	-4	6.4	12.7	2.8	400	11.2	1600	95	65	0.13
836-6-XXX-RL	10	3/8	-6	9.5	15.9	2.8	400	11.2	1600	95	75	0.16
836-8-XXX-RL	12	1/2	-8	12.7	19.8	2.8	400	11.2	1600	95	100	0.27
836-10-XXX-RL	16	5/8	-10	15.9	23.0	2.4	350	9.6	1400	61	125	0.28
836-12-XXX-RL	19	3/4	-12	19.1	26.2	2.1	300	8.4	1200	61	150	0.36

* The vacuum values listed in the table are vacuum pressure values in kPa. For an absolute value subtract the table value from 101 kPa
Note: When ordering, please replace in the part number XXX with the relevant colour code. Example: 836-4-BLK-RL

Colour codes

BLK = black
BLU = blue



RL = only available on reels

Hose layline example

PARKER HI-TEMP PUSH-LOK 836-8 WP 1,7 MPa (250 PSI) MSHA IC-40/22 I • • 12,5 mm (1/2)

837BM

Push-Lok

For a variety of applications including automotive

Primary Applications

All Markets: For a variety of applications
Automotive: For water / air applications

Restrictions

Not permitted for use in air brake systems and high dynamic pulsation systems.
Not recommended for fuels, mineral based hydraulic and lubricating oils and water-oil-emulsion.

Construction

Inner tube: Synthetic rubber
Reinforcement: High-tensile fibre braid
Cover: High performance synthetic rubber in different colours

Temperature Range -40 °C up to +100 °C

Exception: Air max. +70 °C
Water max. +85 °C



- High level of hose flexibility
- High abrasion resistance
- Free from wetting disturbing substances (LABS free)
- Low push-in forces

Recommended Fluids

Air, dry air, water and water-glycol-emulsions.
Consult the chemical compatibility section pages **Ab-26 to Ab-34** for more detailed information.

Fitting Series



Part Number	Hose I.D.				Hose O.D. mm	Pressure Rating				Vacuum* kPa	min. bend radius mm	weight kg
	DN	Inch	Size	mm		max. working pressure		min. burst pressure				
						MPa	psi	MPa	psi			
837BM-4-XXX-RL	6	1/4	-4	6.4	12.7	1.6	235	6.4	940	95	65	0.13
837BM-6-XXX-RL	10	3/8	-6	9.5	15.9	1.6	235	6.4	940	95	75	0.16
837BM-8-XXX-RL	12	1/2	-8	12.7	19.8	1.6	235	6.4	940	95	130	0.27
837BM-10-XXX-RL	16	5/8	-10	15.9	23.0	1.6	235	6.4	940	51	150	0.28
837BM-12-XXX-RL	19	3/4	-12	19.1	26.2	1.6	235	6.4	940	51	180	0.36
837BM-16-XXX-RL	25	1	-16	25.4	32.5	1.6	235	6.4	940	51	250	0.55

* The vacuum values listed in the table are vacuum pressure values in kPa. For an absolute value subtract the table value from 101 kPa
Note: When ordering, please replace in the part number XXX with the relevant colour code. Example: 837BM-4-GRN-RL

Colour codes

BLK = black
BLU = blue
RED = red
GRN = green
GRA = grey



RL = only available on reels

Hose layline example



837PU-Plus

Hybrid Push-Lok

For a variety of high demanding applications

Primary Applications

- All Markets: For high demand applications
For energy chain systems
- Robot and Automotive market:
For hose bundle systems

Restrictions

Not permitted for use in air brake systems and high dynamic pulsation systems.
Not recommended for fuels, mineral based hydraulic and lubricating oils and water-oil-emulsion.

Construction

- Inner tube: Synthetic rubber
Reinforcement: High-tensile fibre braid
Cover: High performance polyurethane material in different colours

Temperature Range -40 °C up to +100 °C

- Exception: Air max. +70 °C
Water max. +85 °C



- High level of hose flexibility
- High abrasion resistance
- High torsion resistance
- Free from wetting disturbing substances (LABS free)
- Low push-in forces

Recommended Fluids

Air, dry air, water and water-glycol-emulsions.
Consult the chemical compatibility section pages **Ab-26** to **Ab-34** for more detailed information.

Fitting Series



Part Number	Hose I.D.				Hose O.D. mm	Pressure Rating				Vacuum* kPa	min. bend radius mm	weight kg
	DN	Inch	Size	mm		max. working pressure MPa	psi	min. burst pressure MPa	psi			
837PU-4-XXX-RL	6	1/4	-4	6.4	12.7	1.6	235	6.4	940	95	30	0.11
837PU-6-XXX-RL	10	3/8	-6	9.5	15.9	1.6	235	6.4	940	95	50	0.15
837PU-8-XXX-RL	12	1/2	-8	12.7	19.8	1.6	235	6.4	940	95	70	0.26
837PU-10-XXX-RL	16	5/8	-10	15.9	23.0	1.6	235	6.4	940	51	90	0.27
837PU-12-XXX-RL	19	3/4	-12	19.1	26.2	1.6	235	6.4	940	51	110	0.33
837PU-16-XXX-RL	25	1	-16	25.4	32.5	1.6	235	6.4	940	51	180	0.52

* The vacuum values listed in the table are vacuum pressure values in kPa. For an absolute value subtract the table value from 101 kPa
Note: When ordering, please replace in the part number XXX with the relevant colour code. Example: 837PU-4-GRN-RL

Colour codes

- BLK = black
BLU = blue
RED = red
GRN = green
GRA = grey



RL = only available on reels

Hose layline example

PARKER PUSH-LOK 837PU-Plus-8 WP 1,6 MPa [235 PSI] | ° 12,5 mm [1/2]

838M

Push-Lok

For non-conductive applications

Primary Applications

Special Market: For special electrical requirements,
e.g. cooling lines with deionized water

Restrictions

Not permitted for use in air brake systems and high dynamic pulsation systems.
Not recommended for fuels.

Construction

Inner tube: Polyurethane material
Reinforcement: High-tensile fibre braid
Cover: Orange colored polyurethane material

Temperature Range -40 °C up to +80 °C

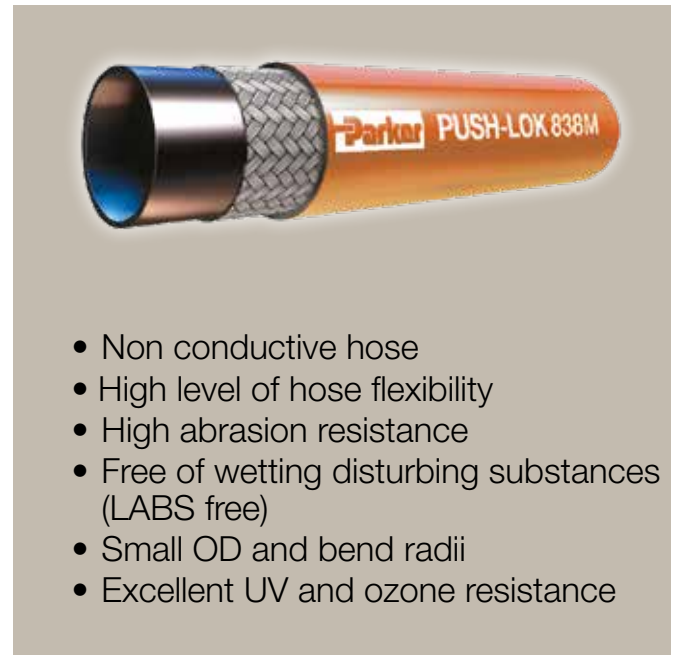

- Non conductive hose
- High level of hose flexibility
- High abrasion resistance
- Free of wetting disturbing substances (LABS free)
- Small OD and bend radii
- Excellent UV and ozone resistance

Recommended Fluids

Mineral based hydraulic and lubricating oils, coolant, antifreeze, air, water, water-oil emulsions.
Consult the chemical compatibility section pages **Ab-26** to **Ab-34** for more detailed information.

Fitting Series



Part Number	Hose I.D.				Hose O.D. mm	Pressure Rating				Vacuum* kPa	min. bend radius mm	weight kg
	DN	Inch	Size	mm		max. working pressure MPa	psi	min. burst pressure MPa	psi			
838M-4-RL	6	1/4	-4	6.4	11.2	1.6	232	6.4	928	10	30	0.08
838M-6-RL	10	3/8	-6	9.5	15.0	1.6	232	6.4	928	10	50	0.13
838M-8-RL	12	1/2	-8	12.7	19.1	1.6	232	6.4	928	10	70	0.20
838M-10-RL	16	5/8	-10	15.9	23.0	1.6	232	6.4	928	10	75	0.26
838M-12-RL	19	3/4	-12	19.1	26.0	1.6	232	6.4	928	10	110	0.31

* The vacuum values listed in the table are vacuum pressure values in kPa. For an absolute value subtract the table value from 101 kPa
RL = only available on reels

Cover color 

Hose layline example



846

Push-Lok

For high oil temperatures

Primary Applications

All markets: Special high temperature applications

Restrictions

Not permitted for use in air brake systems and high dynamic pulsation systems.

Not recommended for fuels.

Construction

Inner tube: PKR synthetic rubber

Reinforcement: High-tensile fibre braid

Cover: MSHA approved black or blue
PKR synthetic rubber

Temperature Range -48 °C up to +150 °C

Exception: Air max. +100 °C

Water max. +85 °C

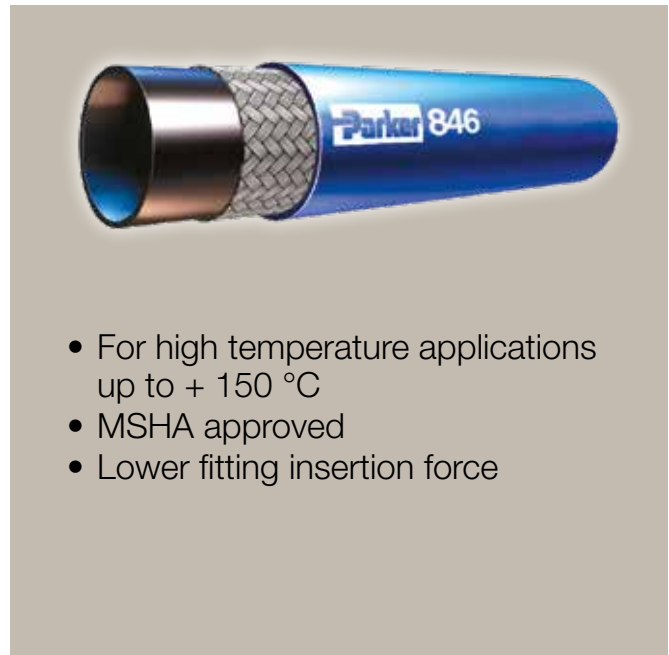

- For high temperature applications up to + 150 °C
- MSHA approved
- Lower fitting insertion force

Recommended Fluids

Mineral based hydraulic and lubricating oils, coolant, antifreeze, air, water and water-oil emulsions.

Consult the chemical compatibility section pages **Ab-26** to **Ab-34** for more detailed information.

Fitting Series



Part Number	Hose I.D.				Hose O.D. mm	Pressure Rating				Vacuum* kPa	min. bend radius mm	weight kg
	DN	Inch	Size	mm		max. working pressure MPa	psi	min. burst pressure MPa	psi			
846-4-XXX-RL	6	1/4	-4	6.4	12.6	1.6	230	6.4	930	95	65	0.13
846-6-XXX-RL	10	3/8	-6	9.5	15.8	1.6	230	6.4	930	95	75	0.19
846-8-XXX-RL	12	1/2	-8	12.7	19.8	1.6	230	6.4	930	95	130	0.27
846-10-XXX-RL	16	5/8	-10	15.9	23.1	1.6	230	6.4	930	51	150	0.31
846-12-XXX-RL**	19	3/4	-12	19.1	26.2	1.6	230	6.4	930	51	180	0.36

* The vacuum values listed in the table are vacuum pressure values in kPa. For an absolute value subtract the table value from 101 kPa
Note: When ordering, please replace in the part number XXX with the relevant colour code. Example: 846-4-GRN-RL

** under development

Colour codes

BLK = black
BLU = blue









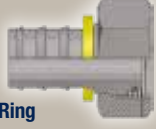

RL = only available on reels

Hose layline example

Parker HI-TEMP PUSH-LOK 846-8 WP 1,6 Mpa (230 PSI) MSHA IC 40/10 1° 12,5 mm (1/2) Q/Y MADE IN ITALY ID

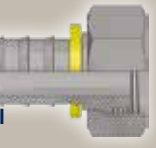

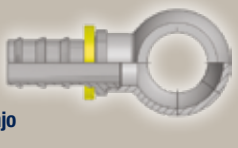

DIN – Metric

Page B1b-1 – B1b-7

<p>CA B1b-1 Female Metric 24° Light Series with O-Ring Swivel – Straight ISO 12151-2-SWS-L – DKOL</p> 	<p>CE B1b-1 Female Metric 24° Light Series with O-Ring Swivel – 45° Elbow ISO 12151-2-SWE-L – DKOL 45°</p> 	<p>CF B1b-2 Female Metric 24° Light Series with O-Ring Swivel – 90° Elbow ISO 12151-2-SWE-L – DKOL 90°</p> 	<p>D0 B1b-2 Male Metric 24° Light Series – Rigid Straight ISO 12151-2-S-L – CEL</p> 
<p>C3 B1b-3 Female Metric Light Series – Swivel Straight (Ball Nose for 24° or 60° Cone) DKL</p> 	<p>C4 B1b-4 Female Metric Light Series – Swivel 45° Elbow (Ball Nose for 24° or 60° Cone) DKL 45°</p> 	<p>C5 B1b-5 Female Metric Light Series – Swivel 90° Elbow (Ball Nose for 24° or 60° Cone) DKL 90°</p> 	<p>49 B1b-6 Metric Banjo Straight DIN 7642</p> 
<p>9B B1b-6 Female Metric Swivel Light Series 45° Elbow (Ball Nose for 24° or 60° Cone)</p> 	<p>9C B1b-7 Female Metric Swivel Light Series 90° Elbow (Ball Nose for 24° or 60° Cone)</p> 		



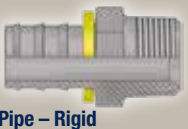
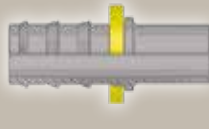

BSP

Page B1b-8 – B1b-10

<p>92 B1b-8 Female BSP Parallel Pipe Swivel – Straight (60° Cone) BS5200-A – DKR</p> 	<p>B1 B1b-8 Female BSP Parallel Pipe Swivel 45° Elbow (60° Cone) BS 5200-D – DKR 45°</p> 	<p>B2 B1b-9 Female BSP Parallel Pipe Swivel 90° Elbow (60° Cone) BS 5200-B – DKR 90°</p> 	<p>D9 B1b-9 Male BSP Parallel Pipe Rigid – Straight (60° Cone) BS5200 – AGR</p> 
<p>91 B1b-10 Male BSP Taper Pipe – Rigid Straight BS5200 – AGR-K</p> 	<p>34 B1b-10 Inch Standpipe (Brass)</p> 		

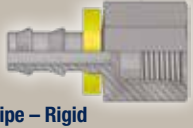
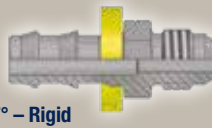
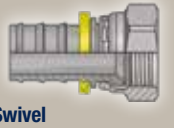
SAE

Page B1b-11 – B1b-14

<p>01 B1b-11 Male NPTF Pipe Rigid – Straight SAE J476A / J516 – AGN</p> 	<p>02 B1b-11 Female NPTF Pipe – Rigid Straight SAE J476A / J516</p> 	<p>03 B1b-12 Male JIC 37° – Rigid Straight ISO12151-5-S – AGJ</p> 	<p>06 B1b-12 Female JIC 37° – Swivel Straight ISO12151-5-SWS – DKJ</p> 
<p>08 B1b-13 Female SAE 45° – Swivel Straight SAE J516</p> 	<p>37 B1b-13 Female JIC 37° – Swivel 45° Elbow ISO 12151-5-SWE 45° – DKJ 45°</p> 	<p>39 B1b-14 Female JIC 37° – Swivel 90° Elbow ISO 12151-5-SWES – DKJ 90°</p> 	

ORFS

Page B1b-15

JC

B1b-15

Female ORFS
Swivel – Straight
Short

ISO 12151-1 – SWSA SAE J516 – ORFS



Others

Page B1b-16 – B1b-18

FF

B1b-16

Metru-Lok Swivel Female

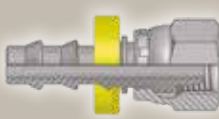

AF

B1b-16

Male BSP Parallel Pipe
Rigid – Straight
(with O-ring Seal)



82

B1b-17

Push-Lok® Union

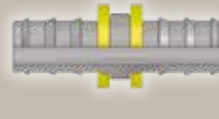

5C

B1b-17

60° Cone Swivel Female

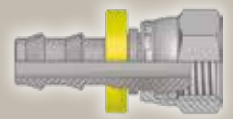

6C

B1b-18

60° Cone Swivel Female
45° Elbow



7C

B1b-18

60° Cone Swivel Female
90° Elbow



82 Series

Assembly Instructions

Page B1b-19

CA

Female Metric 24° Light Series with O-Ring Swivel – Straight

ISO 12151-2-SWS-L – DKOL

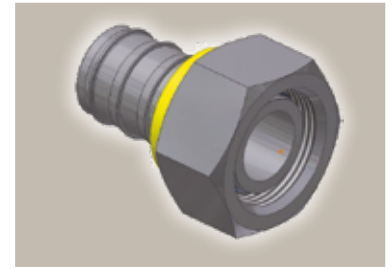
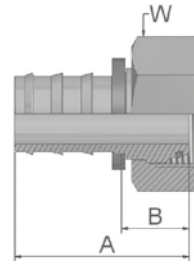

Part Number	Hose I.D.				Thread metric	Tube O.D. mm	A mm	B mm	W mm
	DN	Inch	Size	mm					
3CA82-6-4	6	1/4	-4	6.4	M12x1.5	6	40	21	14
3CA82-6-4B	6	1/4	-4	6.4	M12x1.5	6	40	21	14
3CA82-8-4	6	1/4	-4	6.4	M14x1.5	8	36	18	17
3CA82-8-4B	6	1/4	-4	6.4	M14x1.5	8	36	18	17
3CA82-10-4	6	1/4	-4	6.4	M16x1.5	10	37	18	19
3CA82-10-6	10	3/8	-6	9.5	M16x1.5	10	40	18	19
3CA82-10-6B	10	3/8	-6	9.5	M16x1.5	10	40	18	19
3CA82-12-6	10	3/8	-6	9.5	M18x1.5	12	40	17	22
3CA82-12-6B	10	3/8	-6	9.5	M18x1.5	12	40	17	22
3CA82-15-8	12	1/2	-8	12.7	M22x1.5	15	45	18	27
3CA82-15-8B	12	1/2	-8	12.7	M22x1.5	15	45	18	27
3CA82-15-10B	16	5/8	-10	15.9	M22x1.5	15	61	24	27
3CA82-18-10	16	5/8	-10	15.9	M26x1.5	18	56	19	32
3CA82-22-12	19	3/4	-12	19.1	M30x2	22	58	21	36
3CA82-22-12B	19	3/4	-12	19.1	M30x2	22	58	21	36

Hose fittings are delivered with ozone resistant Nitrile (NBR) O-ring as a standard version. Working temperature from -40 °C up to +105 °C.
Hose fittings with special O-rings (Viton or EPDM) available on request. O-ring dimensions and part-numbers see in section Eb.

CE

Female Metric 24° Light Series with O-Ring Swivel – 45° Elbow

ISO 12151-2-SWE -L – DKOL 45°

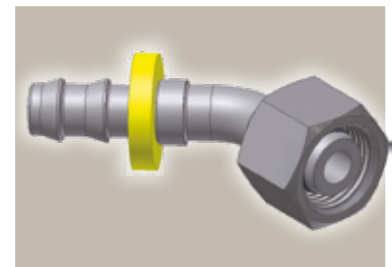
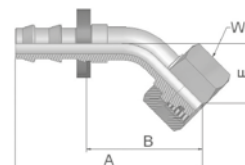

Part Number	Hose I.D.				Thread metric	Tube O.D. mm	A mm	B mm	E mm	W mm
	DN	Inch	Size	mm						
3CE82-6-4	6	1/4	-4	6.4	M12x1.5	6	56	37	21	14
3CE82-8-4	6	1/4	-4	6.4	M14x1.5	8	51	32	16	17
3CE82-10-6	10	3/8	-6	9.5	M16x1.5	10	60	37	19	19
3CE82-12-6	10	3/8	-6	9.5	M18x1.5	12	60	37	19	22
3CE82-15-8	12	1/2	-8	12.7	M22x1.5	15	69	43	21	27
3CE82-18-10	16	5/8	-10	15.9	M26x1.5	18	83	46	23	32
3CE82-22-12	19	3/4	-12	19.1	M30x2	22	97	60	26	36

Hose fittings are delivered with ozone resistant Nitrile (NBR) O-ring as a standard version. Working temperature from -40 °C up to +105 °C.
Hose fittings with special O-rings (Viton or EPDM) available on request. O-ring dimensions and part-numbers see in section Eb.

Also available in stainless steel. Details can be found in CAT 4400.1/UK

Approved **fitting series** for hose types:

B: Brass

82 | 801Plus | 801RH | 804 | 821FR | 830M | 836 | 837BM | 837PU | 838M | 846

CF Female Metric 24° Light Series with O-Ring Swivel – 90° Elbow

ISO 12151-2-SWE-L – DKOL 90°

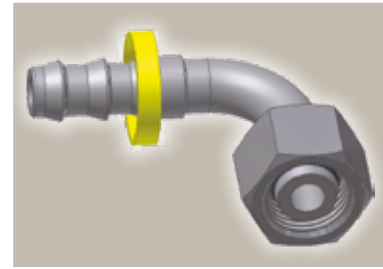
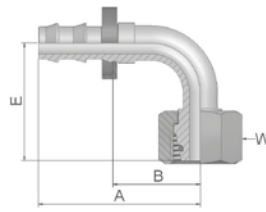

Part Number	Hose I.D.				Thread metric	Tube O.D. mm	A mm	B mm	E mm	W mm
	DN	Inch	Size	mm						
3CF82-6-4	6	1/4	-4	6.4	M12x1.5	6	42	23	36	14
3CF82-8-4	6	1/4	-4	6.4	M14x1.5	8	41	23	29	17
3CF82-10-4	6	1/4	-4	6.4	M16x1.5	10	42	23	32	19
3CF82-10-6	10	3/8	-6	9.5	M16x1.5	10	49	27	36	19
3CF82-10-6B	10	3/8	-6	9.5	M16x1.5	10	49	27	36	19
3CF82-12-6	10	3/8	-6	9.5	M18x1.5	12	49	27	36	22
3CF82-12-6B	10	3/8	-6	9.5	M18x1.5	12	49	27	36	22
3CF82-15-8	12	1/2	-8	12.7	M22x1.5	15	60	34	42	27
3CF82-15-8B	12	1/2	-8	12.7	M22x1.5	15	60	34	42	27
3CF82-18-10	16	5/8	-10	15.9	M26x1.5	18	74	37	45	32
3CF82-22-12	19	3/4	-12	19.1	M30x2	22	88	52	55	36

Hose fittings are delivered with ozone resistant Nitrile (NBR) O-ring as a standard version. Working temperature from -40 °C up to +105 °C.
Hose fittings with special O-rings (Viton or EPDM) available on request. O-ring dimensions and part-numbers see in section Eb.

DO Male Metric 24° Light Series – Rigid Straight

ISO 12151-2-S-L – CEL

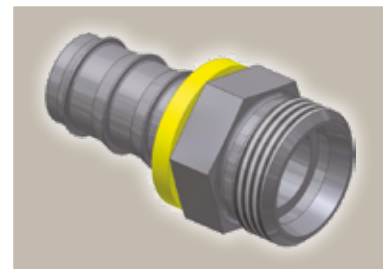
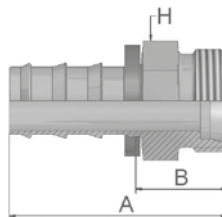

Part Number	Hose I.D.				Thread metric	Tube O.D. mm	A mm	B mm	H mm
	DN	Inch	Size	mm					
3D082-6-4	6	1/4	-4	6.4	M12x1.5	6	35	16	12
3D082-8-4	6	1/4	-4	6.4	M14x1.5	8	36	17	14
3D082-10-6	10	3/8	-6	9.5	M16x1.5	10	41	18	17
3D082-10-6B	10	3/8	-6	9.5	M16x1.5	10	41	18	17
3D082-12-6	10	3/8	-6	9.5	M18x1.5	12	41	18	19
3D082-12-6B	10	3/8	-6	9.5	M18x1.5	12	41	18	19
3D082-15-8	12	1/2	-8	12.7	M22x1.5	15	49	23	22
3D082-15-8B	12	1/2	-8	12.7	M22x1.5	15	49	22	22
3D082-18-8	12	1/2	-8	12.7	M26x1.5	18	48	21	27
3D082-18-10	16	5/8	-10	15.9	M26x1.5	18	58	21	27
3D082-22-12	19	3/4	-12	19.1	M30x2	22	63	27	30
3D082-22-12B	19	3/4	-12	19.1	M30x2	22	63	27	30

Also available in stainless steel. Details can be found in CAT 4400.1/UK

Approved **fitting series** for hose types:

B: Brass

82 801Plus 801RH 804 821FR 830M 836 837BM 837PU 838M 846

C3 Female Metric Light Series – Swivel Straight (Ball Nose for 24° or 60° Cone)

DKL

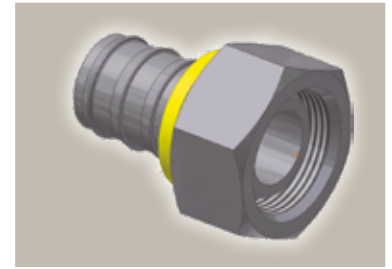
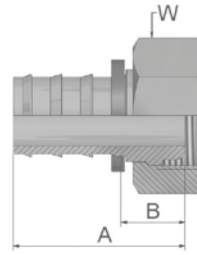

Part Number	Hose I.D.				Thread metric	Tube O.D. mm	A mm	B mm	W mm
	DN	Inch	Size	mm					
3C382-6-4	6	1/4	-4	6.4	M12x1.5	6	33	14	14
3C382-6-4B	6	1/4	-4	6.4	M12x1.5	6	33	14	14
3C382-8-4	6	1/4	-4	6.4	M14x1.5	8	33	14	17
3C382-8-4B	6	1/4	-4	6.4	M14x1.5	8	36	16	19
3C382-10-4	6	1/4	-4	6.4	M16x1.5	10	34	15	19
3C382-10-4B	6	1/4	-4	6.4	M16x1.5	10	34	15	19
3C382-10-6	10	3/8	-6	9.5	M16x1.5	10	37	15	19
3C382-10-6B	10	3/8	-6	9.5	M16x1.5	10	38	15	19
3C382-12-6	10	3/8	-6	9.5	M18x1.5	12	38	16	22
3C382-12-6B	10	3/8	-6	9.5	M18x1.5	12	40	17	22
3C382-15-8	12	1/2	-8	12.7	M22x1.5	15	42	15	27
3C382-15-8B	12	1/2	-8	12.7	M22x1.5	15	42	15	27
3C382-15-10	16	5/8	-10	15.9	M22x1.5	15	56	19	27
3C382-18-10	16	5/8	-10	15.9	M26x1.5	18	53	17	32
3C382-18-10B	16	5/8	-10	15.9	M26x1.5	18	58	22	32
3C382-22-12	19	3/4	-12	19.1	M30x2	22	53	17	36
3C382-22-12B	19	3/4	-12	19.1	M30x2	22	53	17	36
3C382-28-16	25	1	-16	25.4	M36x2	28	58	22	41
3C382-28-16B	25	1	-16	25.4	M36x2	28	58	22	41

82 Series

Also available in stainless steel. Details can be found in CAT 4400.1/UK

Approved fitting series for hose types:

B: Brass

82 801Plus 801RH 804 821FR 830M 836 837BM 837PU 838M 846

C4 Female Metric Light Series – Swivel 45° Elbow (Ball Nose for 24° or 60° Cone)

DKL 45°

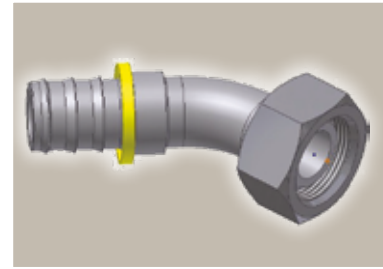
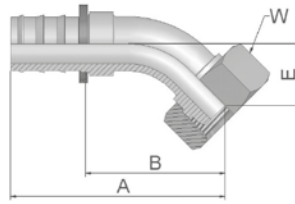

Part Number	Hose I.D.				Thread metric	Tube O.D. mm	A mm	B mm	E mm	W mm
	DN	Inch	Size	mm						
3C482-6-4	6	1/4	-4	6.4	M12x1.5	6	51	32	16	14
3C482-6-4B	6	1/4	-4	6.4	M12x1.5	6	51	32	16	14
3C482-8-4	6	1/4	-4	6.4	M14x1.5	8	51	32	16	17
3C482-8-4B	6	1/4	-4	6.4	M14x1.5	8	51	32	16	17
3C482-10-6	10	3/8	-6	9.5	M16x1.5	10	58	35	18	19
3C482-10-6B	10	3/8	-6	9.5	M16x1.5	10	58	35	17	19
3C482-12-6	10	3/8	-6	9.5	M18x1.5	12	59	36	18	22
3C482-12-6B	10	3/8	-6	9.5	M18x1.5	12	58	36	18	22
3C482-15-8	12	1/2	-8	12.7	M22x1.5	15	68	41	19	27
3C482-15-8B	12	1/2	-8	12.7	M22x1.5	15	67	41	19	27
3C482-15-10	16	5/8	-10	15.9	M22x1.5	15	82	45	21	27
3C482-18-10	16	5/8	-10	15.9	M26x1.5	18	81	45	21	32
3C482-18-10B	16	5/8	-10	15.9	M26x1.5	18	81	45	21	32
3C482-18-12	19	3/4	-12	19.1	M26x1.5	18	96	60	26	32
3C482-22-12	19	3/4	-12	19.1	M30x2	22	88	52	23	36
3C482-22-12B	19	3/4	-12	19.1	M30x2	22	88	52	23	36
3C482-28-16	25	1	-16	25.4	M36x2	28	110	73	31	41

Also available in stainless steel. Details can be found in CAT 4400.1/UK

Approved **fitting series** for hose types:

B: Brass

82 801Plus 801RH 804 821FR 830M 836 837BM 837PU 838M 846

C5 Female Metric Light Series – Swivel 90° Elbow (Ball Nose for 24° or 60° Cone)

DKL 90°

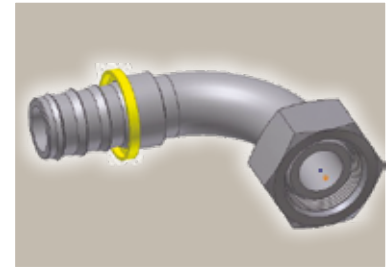
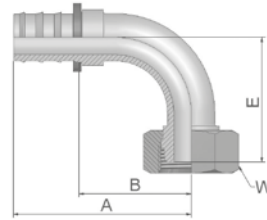

Part Number	Hose I.D.				Thread metric	Tube O.D. mm	A mm	B mm	E mm	W mm
	DN	Inch	Size	mm						
3C582-6-4	6	1/4	-4	6.4	M12x1.5	6	42	23	29	14
3C582-8-4	6	1/4	-4	6.4	M14x1.5	8	42	23	29	17
3C582-8-4B	6	1/4	-4	6.4	M14x1.5	8	41	23	29	17
3C582-10-4	6	1/4	-4	6.4	M16x1.5	10	42	23	29	19
3C582-10-6	10	3/8	-6	9.5	M16x1.5	10	49	27	33	19
3C582-12-6	10	3/8	-6	9.5	M18x1.5	12	49	27	34	22
3C582-12-6B	10	3/8	-6	9.5	M18x1.5	12	49	27	34	22
3C582-15-8	12	1/2	-8	12.7	M22x1.5	15	65	38	39	27
3C582-15-8B	12	1/2	-8	12.7	M22x1.5	15	65	38	39	27
3C582-18-10	16	5/8	-10	15.9	M26x1.5	18	74	37	43	32
3C582-18-10B	16	5/8	-10	15.9	M26x1.5	18	74	37	43	32
3C582-22-12	19	3/4	-12	19.1	M30x2	22	88	51	50	36
3C582-22-12B	19	3/4	-12	19.1	M30x2	22	88	52	50	36
3C582-28-16B	25	1	-16	25.4	M36x2	28	101	64	66	41

82 Series

Also available in stainless steel. Details can be found in CAT 4400.1/UK

Approved **fitting series** for hose types:

B: Brass

82 801Plus 801RH 804 821FR 830M 836 837BM 837PU 838M 846

49 Metric Banjo Straight

DIN 7642

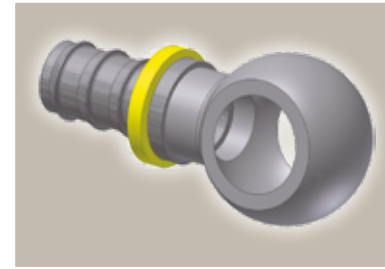
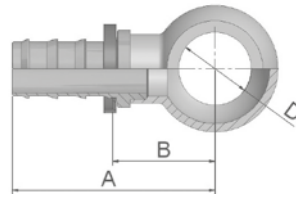

Part Number	Hose I.D.				A mm	B mm	D mm
	DN	Inch	Size	mm			
34982-8-4	6	1/4	-4	6.4	36	17	8
34982-10-4	6	1/4	-4	6.4	38	19	10
34982-12-4	6	1/4	-4	6.4	40	21	12
34982-14-4	6	1/4	-4	6.4	42	23	14
34982-10-6	10	3/8	-6	9.5	42	19	10
34982-12-6	10	3/8	-6	9.5	44	21	12
34982-14-6	10	3/8	-6	9.5	47	24	14
34982-16-6	10	3/8	-6	9.5	49	26	16
34982-17-6	10	3/8	-6	9.5	49	26	17
34982-14-8	12	1/2	-8	12.7	51	25	14
34982-18-8	12	1/2	-8	12.7	55	28	18
34982-22-8	12	1/2	-8	12.7	57	31	22
34982-22-10	16	5/8	-10	15.9	68	32	22
34982-26-12	19	3/4	-12	19.1	74	38	26

9B Female Metric Swivel Light Series

45° Elbow (Ball Nose for 24° or 60° Cone)

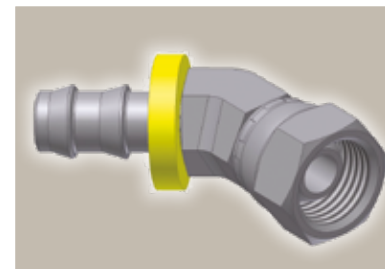
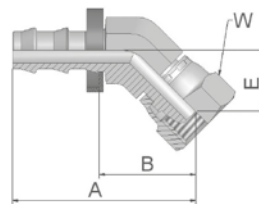

Part Number	Hose I.D.				Thread metric	Tube O.D. mm	A mm	B mm	E mm	W mm
	DN	Inch	Size	mm						
39B82-6-4B	6	1/4	-4	6.4	M12x1.5	6	44	25	16	14
39B82-8-4B	6	1/4	-4	6.4	M14x1.5	8	43	24	15	19
39B82-10-6B	10	3/8	-6	9.5	M16x1.5	10	48	25	16	19
39B82-12-6B	10	3/8	-6	9.5	M18x1.5	12	50	27	17	22
39B82-15-8B	12	1/2	-8	12.7	M22x1.5	15	54	28	18	27

Also available in stainless steel. Details can be found in CAT 4400.1/UK

Approved **fitting series** for hose types:

B: Brass

82 801Plus 801RH 804 821FR 830M 836 837BM 837PU 838M 846

9C

Female Metric Swivel Light Series 90° Elbow (Ball Nose for 24° or 60° Cone)

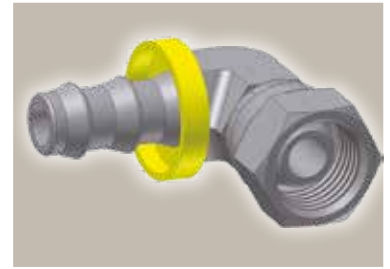
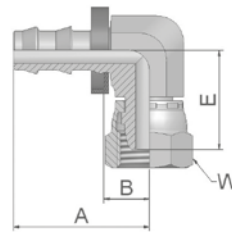

Part Number	Hose I.D.				Thread metric	Tube O.D. mm	A mm	B mm	E mm	W mm
	DN	Inch	Size	mm						
39C82-6-4B	6	1/4	-4	6.4	M12x1.5	6	30	11	22	14
39C82-8-4B	6	1/4	-4	6.4	M14x1.5	8	30	11	22	19
39C82-10-6B	10	3/8	-6	9.5	M16x1.5	10	34	12	25	19
39C82-12-6B	10	3/8	-6	9.5	M18x1.5	12	34	11	25	22
39C82-15-8B	12	1/2	-8	12.7	M22x1.5	15	42	16	32	27

82 Series

Also available in stainless steel. Details can be found in CAT 4400.1/UK

Approved **fitting series** for hose types:

B: Brass

82 801Plus 801RH 804 821FR 830M 836 837BM 837PU 838M 846

92 Female BSP Parallel Pipe Swivel – Straight (60° Cone)

BS5200-A – DKR

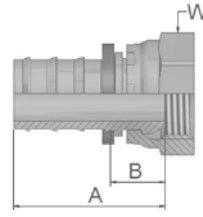

Part Number	Hose I.D.				Thread BSP	A mm	B mm	W mm
	DN	Inch	Size	mm				
39282-4-4	6	1/4	-4	6.4	1/4x19	33	14	17
39282-4-4B	6	1/4	-4	6.4	1/4x19	36	16	17
39282-6-4B	6	1/4	-4	6.4	3/8x19	37	18	22
39282-6-6	10	3/8	-6	9.5	3/8x19	37	14	19
39282-8-8	12	1/2	-8	12.7	1/2x14	42	15	27
39282-8-8B	12	1/2	-8	12.7	1/2x14	46	19	27
39282-10-10	16	5/8	-10	15.9	5/8x14	53	16	30
39282-10-10B	16	5/8	-10	15.9	5/8x14	55	18	30
39282-12-12	19	3/4	-12	19.1	3/4x14	58	21	32
39282-16-16B	25	1	-16	25.4	1x11	57	21	41

B1 Female BSP Parallel Pipe Swivel 45° Elbow (60° Cone)

BS 5200-D – DKR 45°

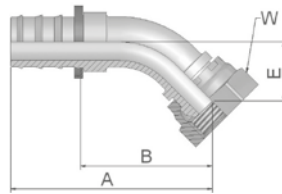

Part Number	Hose I.D.				Thread BSP	A mm	B mm	E mm	W mm
	DN	Inch	Size	mm					
3B182-4-4	6	1/4	-4	6.4	1/4x19	51	32	16	17
3B182-6-6	10	3/8	-6	9.5	3/8x19	58	35	17	19
3B182-6-6B	10	3/8	-6	9.5	3/8x19	58	35	17	19
3B182-8-8	12	1/2	-8	12.7	1/2x14	68	41	19	27
3B182-8-8B	12	1/2	-8	12.7	1/2x14	67	41	19	27
3B182-10-10	16	5/8	-10	15.9	5/8x14	81	45	21	30
3B182-12-12	19	3/4	-12	19.1	3/4x14	92	55	27	32
3B182-16-16	25	1	-16	25.4	1x11	107	71	33	41

Also available in stainless steel. Details can be found in CAT 4400.1/UK

Approved **fitting series** for hose types:

B: Brass

82 801Plus 801RH 804 821FR 830M 836 837BM 837PU 838M 846

B2 Female BSP Parallel Pipe Swivel 90° Elbow (60° Cone)

BS 5200-B – DKR 90°

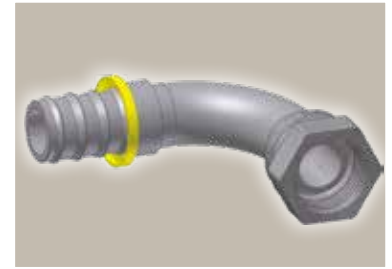
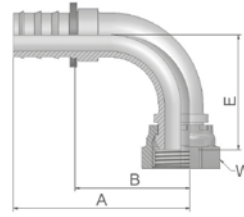

Part Number	Hose I.D.				Thread BSP	A mm	B mm	E mm	W mm
	DN	Inch	Size	mm					
3B282-4-4	6	1/4	-4	6.4	1/4x19	42	23	29	17
3B282-6-6	10	3/8	-6	9.5	3/8x19	49	26	33	19
3B282-8-8	12	1/2	-8	12.7	1/2x14	60	34	39	27
3B282-8-8B	12	1/2	-8	12.7	1/2x14	60	34	39	27
3B282-10-8	12	1/2	-8	12.7	5/8x14	58	32	40	30
3B282-10-10	16	5/8	-10	15.9	5/8x14	74	37	43	30
3B282-10-10B	16	5/8	-10	15.9	5/8x14	74	37	44	30
3B282-12-12	19	3/4	-12	19.1	3/4x14	83	46	53	32
3B282-12-12B	19	3/4	-12	19.1	3/4x14	83	46	53	32
3B282-16-16	25	1	-16	25.4	1x11	99	63	68	41

82 Series

D9 Male BSP Parallel Pipe Rigid – Straight (60° Cone)

BS5200 – AGR

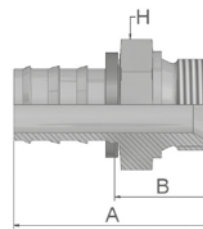

Part Number	Hose I.D.				Thread BSP	A mm	B mm	H mm
	DN	Inch	Size	mm				
3D982-2-4	6	1/4	-4	6.4	1/8x28	36	17	14
3D982-4-4	6	1/4	-4	6.4	1/4x19	41	23	19
3D982-4-4B	6	1/4	-4	6.4	1/4x19	41	23	19
3D982-4-6	10	3/8	-6	9.5	1/4x19	44	21	19
3D982-4-6B	10	3/8	-6	9.5	1/4x19	44	21	19
3D982-6-6	10	3/8	-6	9.5	3/8x19	45	23	22
3D982-8-8	12	1/2	-8	12.7	1/2x14	53	27	27
3D982-8-8B	12	1/2	-8	12.7	1/2x14	53	27	27
3D982-8-10	16	5/8	-10	15.9	1/2x14	62	25	27
3D982-12-12	19	3/4	-12	19.1	3/4x14	65	28	32

Also available in stainless steel. Details can be found in CAT 4400.1/UK

Approved fitting series for hose types:

B: Brass

82 | 801Plus | 801RH | 804 | 821FR | 830M | 836 | 837BM | 837PU | 838M | 846

91 Male BSP Taper Pipe – Rigid Straight

BS5200 – AGR-K

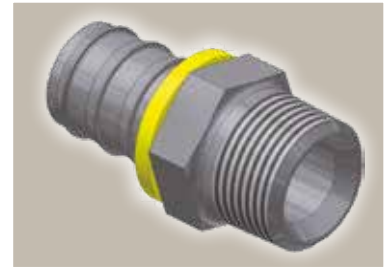
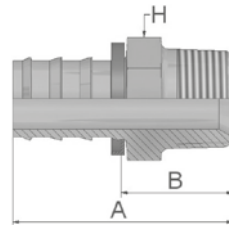

Part Number	Hose I.D.				Thread BSP	A mm	B mm	H mm
	DN	Inch	Size	mm				
39182-2-4B	6	1/4	-4	6.4	1/8x28	37	18	12
39182-4-4B	6	1/4	-4	6.4	1/4x19	40	21	14
39182-4-6B	10	3/8	-6	9.5	1/4x19	44	21	14
39182-6-6B	10	3/8	-6	9.5	3/8x19	45	22	19
39182-6-8B	12	1/2	-8	12.7	3/8x19	49	22	19
39182-8-8B	12	1/2	-8	12.7	1/2x14	55	29	22
39182-8-10B	16	5/8	-10	15.9	1/2x14	65	28	22
39182-12-10B	16	5/8	-10	15.9	3/4x14	69	32	30
39182-12-12B	19	3/4	-12	19.1	3/4x14	69	32	30

34 Inch Standpipe (Brass)

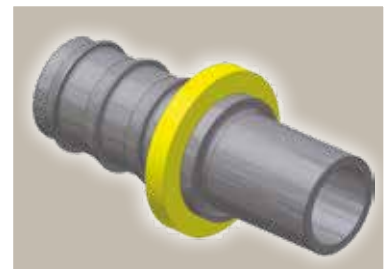
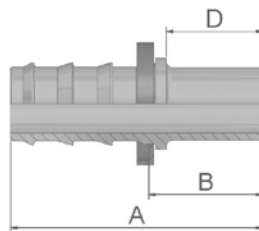

Part Number	Hose I.D.				Tube O.D. mm	A mm	B mm	D mm
	DN	Inch	Size	mm				
33482-4-4B	6	1/4	-4	6.4	4	48	29	26
33482-6-6B	10	3/8	-6	9.5	6	57	34	31
33482-8-8B	12	1/2	-8	12.7	8	55	28	25
33482-10-10B	16	5/8	-10	15.9	10	67	30	25
33482-12-12B	19	3/4	-12	19.1	12	67	30	25

Also available in stainless steel. Details can be found in CAT 4400.1/UK

Approved **fitting series** for hose types:

B: Brass

82 801Plus 801RH 804 821FR 830M 836 837BM 837PU 838M 846

01

Male NPTF Pipe Rigid – Straight

SAE J476A/ J516 – AGN

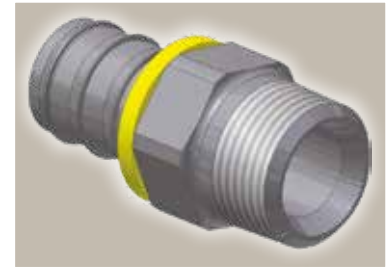
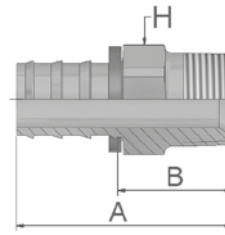

Part Number	Hose I.D.				Thread NPTF	A mm	B mm	H	
	DN	Inch	Size	mm				mm	Inch
30182-2-4	6	1/4	-4	6.4	1/8x27	35	16	7/16	
30182-2-4B	6	1/4	-4	6.4	1/8-27	35	16	7/16	
30182-4-4	6	1/4	-4	6.4	1/4x18	40	21	9/16	
30182-4-4B	6	1/4	-4	6.4	1/4-18	40	21	9/16	
30182-4-6	10	3/8	-6	9.5	1/4x18	45	22	9/16	
30182-4-6B	10	3/8	-6	9.5	1/4-18	45	22	9/16	
30182-6-6	10	3/8	-6	9.5	3/8x18	45	22	11/16	
30182-6-8B	12	1/2	-8	12.7	3/8-18	49	22	11/16	
30182-8-8	12	1/2	-8	12.7	1/2x14	55	29	7/8	
30182-8-8B	12	1/2	-8	12.7	1/2x14	55	29	7/8	
30182-8-10B	16	5/8	-10	15.9	1/2-14	66	29	7/8	
30182-12-10	16	5/8	-10	15.9	3/4-14	66	29	1 1/16	
30182-8-12B	19	3/4	-12	19.1	1/2-14	66	29	7/8	
30182-12-12	19	3/4	-12	19.1	3/4-14	66	29	1 1/16	
30182-12-12B	19	3/4	-12	19.1	3/4-14	66	29	1 1/16	

82 Series

02

Female NPTF Pipe – Rigid Straight

SAE J476A/ J516

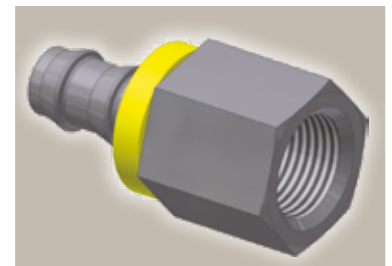
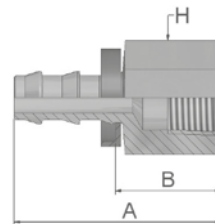

Part Number	Hose I.D.				Thread NPTF	A mm	B mm	H	
	DN	Inch	Size	mm				mm	Inch
30282-4-4B	6	1/4	-4	6.4	1/4x18	40	21	3/4	
30282-6-6B	10	3/8	-6	9.5	3/8x18	46	23	7/8	
30282-8-8B	12	1/2	-8	12.7	1/2x14	55	28	1 1/16	

Also available in stainless steel. Details can be found in CAT 4400.1/UK

Approved **fitting series** for hose types:

B: Brass

82 801Plus 801RH 804 821FR 830M 836 837BM 837PU 838M 846

03 Male JIC 37° – Rigid Straight

ISO12151-5-S – AGJ

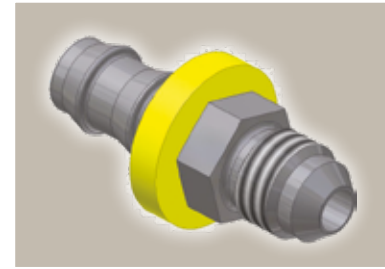
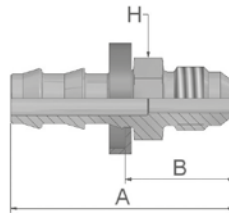

Part Number	Hose I.D.				Thread UNF	A mm	B mm	H Inch
	DN	Inch	Size	mm				
30382-4-4	6	1/4	-4	6.4	7/16x20	40	21	1/2
30382-6-6	10	3/8	-6	9.5	9/16x18	45	22	5/8
30382-6-6B	10	3/8	-6	9.5	9/16x18	45	22	5/8
30382-8-8	12	1/2	-8	12.7	3/4x16	52	26	3/4
30382-12-12	19	3/4	-12	19.1	1 1/16x12	69	32	1 1/8

06 Female JIC 37° – Swivel Straight

ISO12151-5-SWS – DKJ

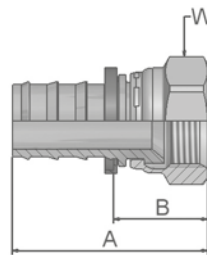

Part Number	Hose I.D.				Thread UNF	A mm	B mm	W mm Inch
	DN	Inch	Size	mm				
30682-4-4	6	1/4	-4	6.4	7/16x20	39	20	9/16
30682-4-4B	6	1/4	-4	6.4	7/16x20	39	19	9/16
30682-5-4B	6	1/4	-4	6.4	1/2x20	40	21	5/8
30682-6-4B	6	1/4	-4	6.4	9/16x18	42	22	11/16
30682-5-6B	10	3/8	-6	9.5	1/2x20	44	21	5/8
30682-6-6	10	3/8	-6	9.5	9/16x18	44	22	11/16
30682-6-6B	10	3/8	-6	9.5	9/16x18	44	22	11/16
30682-8-6B	10	3/8	-6	9.5	3/4x16	47	25	7/8
30682-8-8	12	1/2	-8	12.7	3/4x16	51	25	7/8
30682-8-8B	12	1/2	-8	12.7	3/4x16	51	25	7/8
30682-10-8B	12	1/2	-8	12.7	7/8x14	52	25	1
30682-10-10	16	5/8	-10	15.9	7/8x14	65	28	1
30682-10-10B	16	5/8	-10	15.9	7/8x14	62	25	1
30682-12-12	19	3/4	-12	19.1	1 1/16x12	67	30	1 1/4
30682-12-12B	19	3/4	-12	19.1	1 1/16x12	67	30	1 1/4

Also available in stainless steel. Details can be found in CAT 4400.1/UK

Approved **fitting series** for hose types:

B: Brass

82 801Plus 801RH 804 821FR 830M 836 837BM 837PU 838M 846

08 Female SAE 45° – Swivel Straight

SAE J516

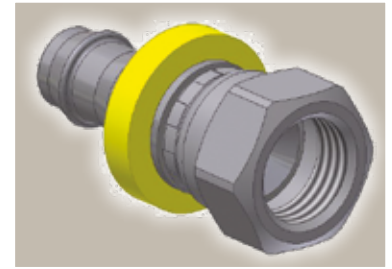
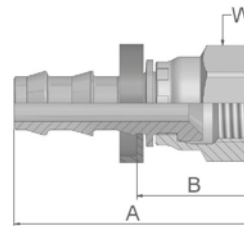

Part Number	Hose I.D.				Thread UNF	A mm	B mm	W inch
	DN	Inch	Size	mm				
30882-4-4	6	1/4	-4	6.4	7/16x20	39	19	9/16
30882-4-4B	6	1/4	-4	6.4	7/16x20	39	19	9/16
30882-5-4B	6	1/4	-4	6.4	1/2x20	40	21	5/8
30882-6-6	10	3/8	-6	9.5	5/8x18	46	23	3/4
30882-6-6B	10	3/8	-6	9.5	5/8x18	46	23	3/4
30882-8-8	12	1/2	-8	12.7	3/4x16	51	25	7/8
30882-8-8B	12	1/2	-8	12.7	3/4x16	51	25	7/8
30882-10-10	16	5/8	-10	15.9	7/8x14	65	28	1
30882-10-10B	16	5/8	-10	15.9	7/8x14	65	28	1
30882-12-12	19	3/4	-12	19.1	1 1/16x14	67	30	1 1/4
30882-12-12B	19	3/4	-12	19.1	1 1/16x14	67	30	1 1/4

82 Series

37 Female JIC 37° – Swivel 45° Elbow

ISO 12151-5-SWE 45° – DKJ 45°

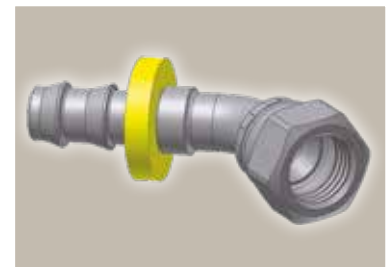
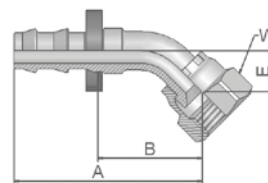

Part Number	Hose I.D.				Thread UNF	A mm	B mm	E mm	W mm Inch
	DN	Inch	Size	mm					
33782-4-4	6	1/4	-4	6.4	7/16x20	39	20	8	9/16
33782-6-6	10	3/8	-6	9.5	9/16x18	51	28	11	11/16
33782-8-8	12	1/2	-8	12.7	3/4x16	54	35	14	7/8

Also available in stainless steel. Details can be found in CAT 4400.1/UK

Approved fitting series for hose types:

B: Brass

82 801Plus 801RH 804 821FR 830M 836 837BM 837PU 838M 846

39 Female JIC 37° – Swivel 90° Elbow

ISO 12151-5-SWES – DKJ 90°

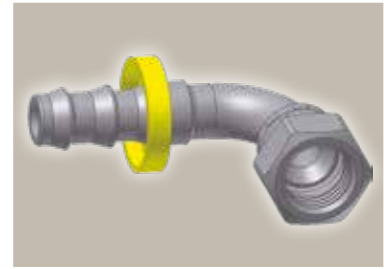
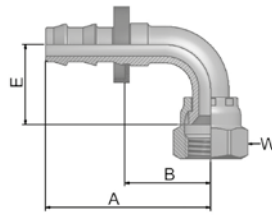

Part Number	Hose I.D.				Thread UNF	A mm	B mm	E mm	W	
	DN	Inch	Size	mm					mm	Inch
33982-4-4	6	1/4	-4	6.4	7/16x20	39	20	21	9/16	
33982-6-6	10	3/8	-6	9.5	9/16x18	47	24	23	11/16	
33982-8-8	12	1/2	-8	12.7	3/4x16	55	32	29	7/8	
33982-10-10	16	5/8	-10	15.9	7/8x14	74	37	31	1	
33982-12-12	19	3/4	-12	19.1	1 1/16x12	83	46	48	1 1/4	

Also available in stainless steel. Details can be found in CAT 4400.1/UK

Approved **fitting series** for hose types:

B: Brass

82 801Plus 801RH 804 821FR 830M 836 837BM 837PU 838M 846

JC

**Female ORFS
Swivel – Straight
Short**

ISO 12151-1 – SWSA
SAE J516 – ORFS

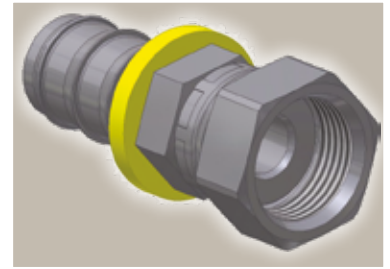
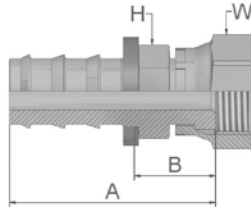

Part Number	Hose I.D.				Thread UNF	A mm	B mm	H		W	
	DN	Inch	Size	mm				mm	Inch	mm	Inch
3JC82-4-4	6	1/4	-4	6.4	9/16x18	36	17	9/16		11/16	
3JC82-6-6	10	3/8	-6	9.5	11/16x16	40	18	11/16		13/16	
3JC82-10-10	16	5/8	-10	15.9	1x14	61	24	15/16		1 1/8	
3JC82-12-12	19	3/4	-12	19.1	1 3/16x12	67	30	1 1/8		1 3/8	

82 Series

Also available in stainless steel. Details can be found in CAT 4400.1/UK

Approved **fitting series** for hose types:

B: Brass

82 801Plus 801RH 804 821FR 830M 836 837BM 837PU 838M 846

FF Metru-Lok Swivel Female

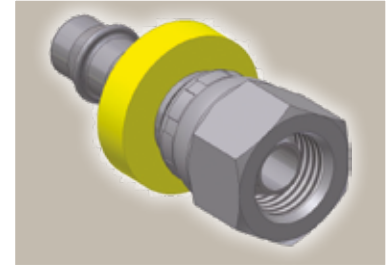
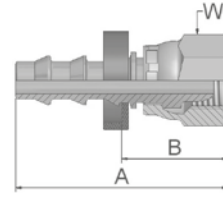

Part Number	Hose I.D.				Thread metric	Tube O.D. mm	A mm	B mm	W mm
	DN	Inch	Size	mm					
3FF82-6-4B	6	1/4	-4	6.4	M10x1	6	36	16	14
3FF82-8-4B	6	1/4	-4	6.4	M12x1	8	31	12	14
3FF82-10-6B	10	3/8	-6	9.5	M14x1	10	35	12	17
3FF82-12-6B	10	3/8	-6	9.5	M16x1	12	35	12	19
3FF82-14-8B	12	1/2	-8	12.7	M18x1	14	38	12	22
3FF82-16-8B	12	1/2	-8	12.7	M22x1.5	16	38	12	27
3FF82-18-10B	16	5/8	-10	15.9	M24x1.5	18	51	15	27
3FF82-22-12B	19	3/4	-12	19.1	M28x1.5	22	51	15	32

AF Male BSP Parallel Pipe Rigid – Straight (with O-ring Seal)

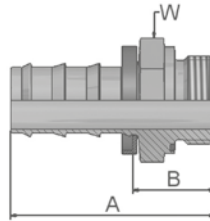

Part Number	Hose I.D.				Thread BSP	A mm	B mm	W mm
	DN	Inch	Size	mm				
3AF82-2-4B	6	1/4	-4	6.4	1/8x28	34	15	17
3AF82-4-4B	6	1/4	-4	6.4	1/4x19	39	20	19
3AF82-4-6B	10	3/8	-6	9.5	1/4x19	43	20	19
3AF82-6-6B	10	3/8	-6	9.5	3/8x19	46	23	22
3AF82-6-8B	12	1/2	-8	12.7	3/8x19	49	22	22
3AF82-8-8B	12	1/2	-8	12.7	1/2x14	53	26	27
3AF82-8-10B	16	5/8	-10	15.9	1/2x14	63	27	27

Also available in stainless steel. Details can be found in CAT 4400.1/UK

Approved **fitting series** for hose types:

B: Brass

82 801Plus 801RH 804 821FR 830M 836 837BM 837PU 838M 846

82 Push-Lok® Union

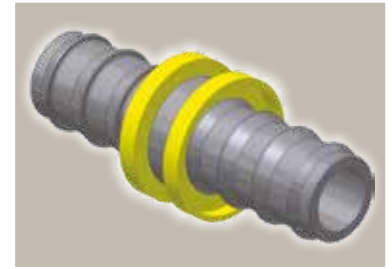
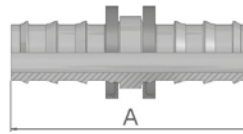

Part Number	Hose I.D.				A mm
	DN	Inch	Size	mm	
38282-4-4	6	1/4	-4	6.4	45
38282-4-4B	6	1/4	-4	6.4	46
38282-6-6B	10	3/8	-6	9.5	55
38282-8-8	12	1/2	-8	12.7	64
38282-8-8B	12	1/2	-8	12.7	64
38282-10-10	16	5/8	-10	15.9	84
38282-10-10B	16	5/8	-10	15.9	84
38282-12-12	19	3/4	-12	19.1	84
38282-12-12B	19	3/4	-12	19.1	84

82 Series

5C 60° Cone Swivel Female

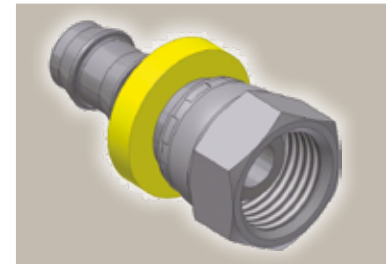
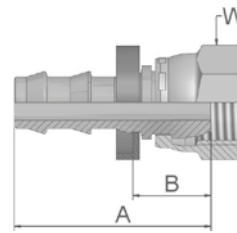

Part Number	Hose I.D.				Thread metric	A mm	B mm	W mm
	DN	Inch	Size	mm				
35C82-6-4B	6	1/4	-4	6.4	M12x1.5	33	14	14
35C82-10-6B	10	3/8	-6	9.5	M16x1.5	38	15	19
35C82-15-8B	12	1/2	-8	12.7	M22x1.5	44	18	27
35C82-18-10B	16	5/8	-10	15.9	M26x1.5	57	21	32

Also available in stainless steel. Details can be found in CAT 4400.1/UK

Approved **fitting series** for hose types:

B: Brass

82 801Plus 801RH 804 821FR 830M 836 837BM 837PU 838M 846

6C 60° Cone Swivel Female 45° Elbow

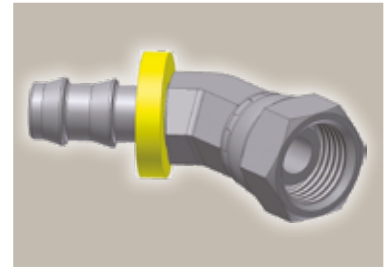
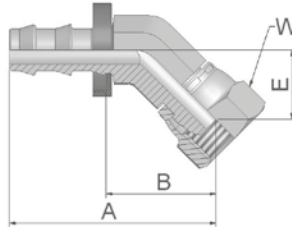

Part Number	Hose I.D.				Thread metric	A mm	B mm	E mm	W mm
	DN	Inch	Size	mm					
36C82-6-4B	6	1/4	-4	6.4	M12x1.5	44	25	16	14
36C82-10-6B	10	3/8	-6	9.5	M16x1.5	48	26	16	19
36C82-15-8B	12	1/2	-8	12.7	M22x1.5	54	28	18	27

7C 60° Cone Swivel Female 90° Elbow

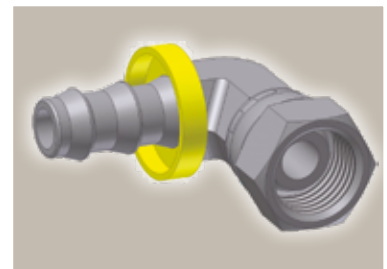
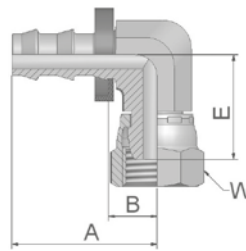

Part Number	Hose I.D.				Thread metric	A mm	B mm	E mm	W mm
	DN	Inch	Size	mm					
37C82-6-4B	6	1/4	-4	6.4	M12x1.5	30	11	22	14
37C82-10-6B	10	3/8	-6	9.5	M16x1.5	34	12	25	19
37C82-15-8B	12	1/2	-8	12.7	M22x1.5	43	16	32	27

Also available in stainless steel. Details can be found in CAT 4400.1/UK

Approved **fitting series** for hose types:

B: Brass

82 801Plus 801RH 804 821FR 830M 836 837BM 837PU 838M 846

Easy assembly – no tools or clamps required

Assembly Instructions



1. Cut the hose right angled with a sharp knife. If necessary it is possible to use a lubricant (water/soap solution with 5 % soap fluid and 95 % water) for easy assembly.

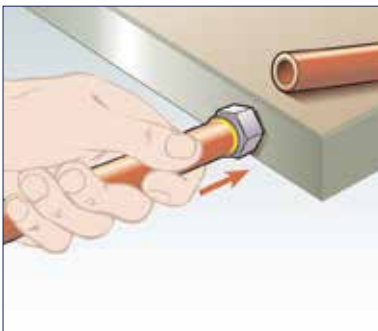

2. Insert fitting into hose until first barb is in hose. Place end of fitting against a flat object (bench, door, wall) and grip hose approximately 1" from end and push with a steady force until end of hose is covered by yellow plastic collar. Alternatively please use the Parker Assembly Tool No. 611050G or 611050HV.

Attention!

During assembly, please keep in mind that Push-Lok fittings will provide an effective grip only when the Push-Lok hose is pushed fully on the insert, where the cropped end of the hose should be fully concealed by the plastic collar. **For easy assembly of hose 830M, 837BM and 837PU please use only Push-Lok Assembly Oil No. H896137.** Push-Lok Assembly Oil is free from wetting disturbing substances. Don't use oil, lubricant or soap fluids for this hose!

Disassembly Instructions

1. Cut lengthwise along a line at approximately a 20 angle from centre line of hose. The cut should be approximately 1" long. Be careful not to nick barbs when cutting the hose.



2. Grip hose and give a sharp down-ward tug to disengage from fitting.

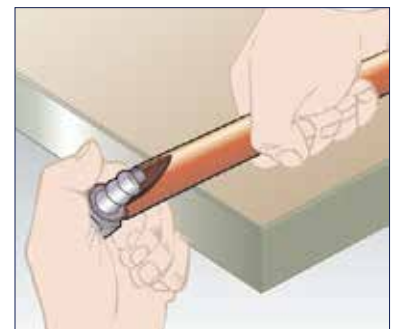

Attention!

Before re-use of the nipple please check nipple for damage. Damaged nipples can cause leakage.

Low Pressure Transportation and Hydraulic Hose and Fittings

– the right solution for special applications and requirements

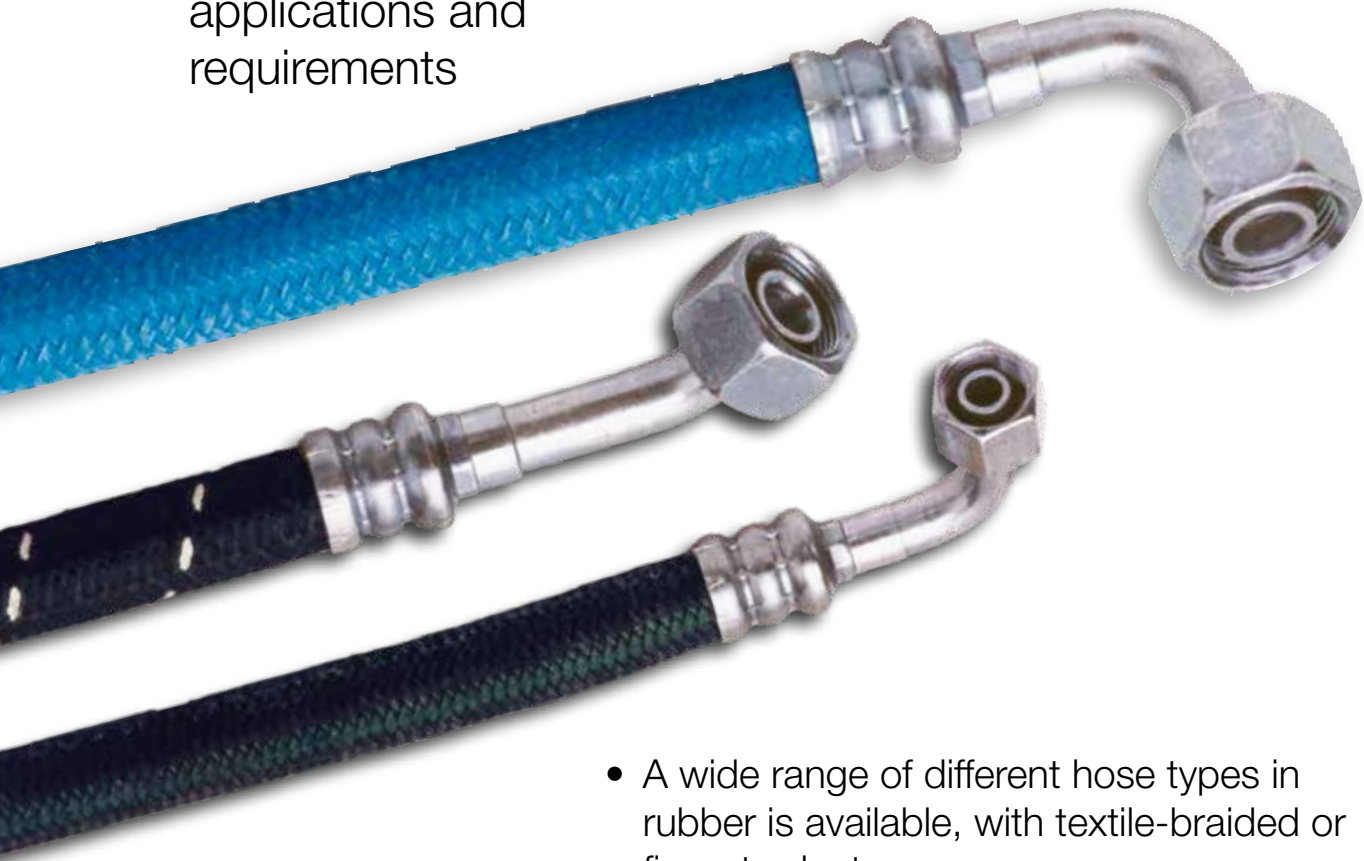

- A wide range of different hose types in rubber is available, with textile-braided or fire-retardant covers
- Proven, safe and easy self-assembly system
- Large bore sizes available
- High working temperatures
- One fitting series for all SAE 100 R5 and similar hoses



Applications

The definitive hose range for all special applications and requirements



Parkrimp® *No-Skive*

The system for fast and leak-free assemblies

The perfect match



Parker's colour-coded die sets

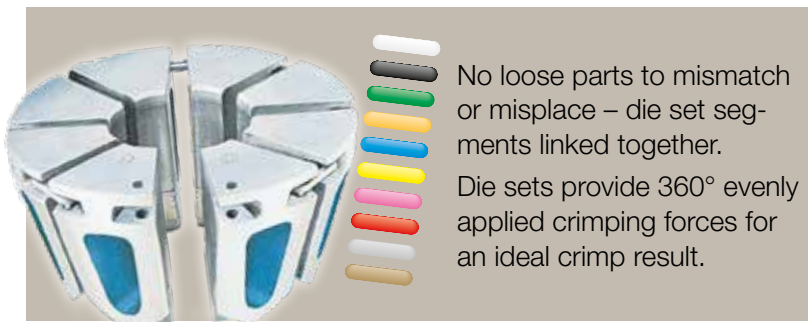

Parkalign®



Parkrimp® *No-Skive*

- No skiving tool needed
- No need to remove the cover
- Crimps one-piece fittings
- Parkalign positions the fittings in the dies perfectly every time
- Quick and easy: no gauges to set on the machine
- Portable machines for field repair
- Meets EN safety regulations

Low Pressure Transportation and Hydraulic

Hoses			Page
201	Transportation		B2a-1
206	Transportation		B2a-2
213	Transportation		B2a-3
221FR	Fire retardant		B2a-4
244	Refrigeration		B2a-5
285	Refrigeration		B2a-6
293	Transportation		B2a-7
611HT	High temperature		B2a-8
681	Standard		B2a-9
681DB	Railway		B2a-10

Fittings Series	26
Chapter	B2b
DIN - Metric	1 - 2
SAE	3 - 5
ORFS	6
Others	7

Parker Hannifin assumes no liability for typographical errors or other errors

Standard



High temperature



Railway



Transportation



Fire retardant



Refrigeration



201

No-Skive Airbrake

SAE 100R5 – SAE J1402AII

Primary Applications

Transportation: Air brake hose

General: Low pressure applications

Type Approvals

Details please find on pages **Ab-16** to **Ab-19**

Applicable Specifications

SAE 100R5, SAE J1402AII, D. O. T. FMVSS 106-AII

Construction

Inner tube: Synthetic rubber

Reinforcement: One fibre braid
One high-tensile steel wire braid

Cover: Rubber layer and textile braided cover

Temperature Range -40 °C up to +150 °C

Exception: Air max. +70 °C

Water max. +85 °C



- Textile braided cover
- **No-Skive** hose construction
- 150 °C working temperature

Recommended Fluids

Petroleum based hydraulic fluids, water-glycol and water-oil emulsion hydraulic fluids, grease, lubricants, crude and fuel oils, air and water.

Consult the chemical compatibility section on pages **Ab-26** to **Ab-34** for more detailed information.

Fitting Series



Part Number	Hose I.D.			Hose O.D.			Pressure Rating				Vacuum*	min. bend radius	weight
	Inch	Size	mm	mm	max. working pressure		min. burst pressure						
					MPa	psi	MPa	psi					
201-4	3/16	-4	5.0	12.2	20.7	3000	83.0	12000	95	75	0.22		
201-5	1/4	-5	6.3	14.8	20.7	3000	83.0	12000	95	85	0.27		
201-6	5/16	-6	8.0	17.2	15.5	2250	62.0	9000	95	100	0.34		
201-8	13/32	-8	10.0	19.5	13.8	2000	55.0	8000	95	120	0.40		
201-10	1/2	-10	12.5	23.4	12.0	1750	48.0	7000	95	140	0.55		
201-12	5/8	-12	16.0	27.4	10.3	1500	41.0	6000	95	165	0.68		
201-16	7/8	-16	22.0	31.4	5.5	800	22.0	3200	67	185	0.68		
201-20	1 1/8	-20	29.0	38.1	4.3	625	17.0	2500	67	230	0.76		
201-24	1 3/8	-24	35.0	44.5	3.5	500	14.0	2000	51	265	1.01		
201-32	1 13/16	-32	46.0	56.4	2.4	350	10.0	1400	37	335	1.32		

* The vacuum values listed in the table are vacuum pressure values in kPa. For an absolute value subtract the table value from 101kPa. The combination of high temperature and high pressure could reduce the hose life. The maximum working pressures shown in the table are for service up to a maximum temperature of 100 °C. For use at higher temperatures, consult the pressure/temperature curve in section A for the reduced maximum working pressure.

Hose layline example

Parker 201-6 AIR BRAKE DOT XXXXX AII 8 mm (5/16) SAE J1402 DOT XXXXX AII WP 15,7 MPa (2250 PSI) DOT XXXXX AII SA

206

No-Skive Airbrake

SAE 100R5 – SAE J1402All

Primary Applications

Transportation: Air brake hose
General: Low pressure applications

Type Approvals

Details please find on pages **Ab-16** to **Ab-19**

Applicable Specifications

SAE 100R5, SAE J1402All, D. O. T. FMVSS 106-All

Construction

Inner tube: PKR synthetic rubber
Reinforcement: One fibre braid
One high-tensile steel wire braid
Cover: Rubber layer and
blue textile braided cover

Temperature Range -48 °C up to +150 °C

Exception: Air max. +100 °C
Water max. +85 °C



- Blue textile braided cover
- *No-Skive* hose construction
- For very low (-48 °C) working temperature

Recommended Fluids

Petroleum based hydraulic fluids, water-glycol and water-oil emulsion hydraulic fluids, grease, lubricants, crude and fuel oils, air and water.
Consult the chemical compatibility section on pages **Ab-26** to **Ab-34** for more detailed information.

Fitting Series



Part Number	Hose I.D.			Hose O.D. mm	Pressure Rating				Vacuum* kPa	min. bend radius mm	weight kg
	Inch	Size	mm		max. working pressure MPa	psi	min. burst pressure MPa	psi			
206-4	3/16	-4	5.0	13.2	20.7	3000	83.0	12000	95	75	0.22
206-5	1/4	-5	6.3	14.8	20.7	3000	83.0	12000	95	85	0.27
206-6	5/16	-6	8.0	17.1	15.5	2250	62.0	9000	95	90	0.34
206-8	13/32	-8	10.0	19.5	13.8	2000	55.0	8000	95	90	0.40
206-10	1/2	-10	12.5	23.4	12.0	1750	48.0	7000	95	100	0.55
206-12	5/8	-12	16.0	27.4	10.3	1500	41.0	6000	95	100	0.68
206-16	7/8	-16	22.0	31.4	5.5	800	22.0	3200	67	100	0.68
206-20	1 1/8	-20	29.0	38.1	4.3	625	17.0	2500	67	140	0.76
206-24	1 3/8	-24	35.0	44.5	3.5	500	14.0	2000	51	190	1.01
206-32	1 13/16	-32	46.0	56.4	2.4	350	10.0	1400	37	335	1.32

* The vacuum values listed in the table are vacuum pressure values in kPa. For an absolute value subtract the table value from 101kPa.
The combination of high temperature and high pressure could reduce the hose life.
The maximum working pressures shown in the table are for service up to a maximum temperature of 100 °C.
For use at higher temperatures, consult the pressure/temperature curve in section A for the reduced maximum working pressure.

Hose layline example

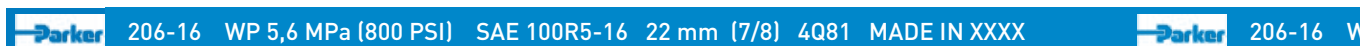

213

No-Skive High Temperature

For engines and compressed air systems



- *No-Skive* hose construction
- Ideal for high-temperature and small bend radii applications
- Compatible with a large range of fluids

Primary Applications

Transportation: Air brake hose
Compressors: Compressed air hose

Type Approvals

Details please find on pages **Ab-16** to **Ab-19**

Applicable Specifications

SAE J1402AI, D.O.T. FMVSS 106-AI

Construction

Inner tube: PKR synthetic rubber
Reinforcement: One fibre braid
One high-tensile steel wire braid
Cover: Rubber layer and
black textile braided cover
include 2 green strips

Recommended Fluids

Petroleum based hydraulic fluids, water-glycol and water-oil emulsion hydraulic fluids, grease, lubricants, crude and fuel oils, air and water.
Consult the chemical compatibility section on pages **Ab-26** to **Ab-34** for more detailed information.

Temperature Range -45 °C up to +150 °C
Exception: Air max. +100 °C
Water max. +85 °C

Fitting Series



Part Number	Hose I.D.			Hose O.D. mm	Pressure rating				min. bend radius mm	weight kg
	Inch	Size	mm		max. working pressure		min. burst pressure			
					MPa	psi	MPa	psi		
213-4	3/16	-4	5.0	12.5	13.8	2000	55.0	8000	20	0.18
213-5	1/4	-5	6.3	14.1	10.3	1500	41.0	6000	25	0.21
213-6	5/16	-6	8.0	15.7	10.3	1500	41.0	6000	30	0.25
213-8	13/32	-8	10.0	18.7	8.6	1250	34.0	5000	45	0.30
213-10	1/2	-10	12.5	21.1	6.9	1000	28.0	4000	55	0.33
213-12	5/8	-12	16.0	24.3	5.2	750	21.0	3000	70	0.36
213-16	7/8	-16	22.0	30.6	2.8	400	11.0	1600	90	0.45
213-20	1 1/8	-20	29.0	37.8	2.1	300	8.0	1200	115	0.65
213-24	1 3/8	-24	35.0	44.0	1.7	300	8.0	1200	190	0.73
213-32	1 13/16	-32	46.0	54.5	1.4	200	5.5	800	355	1.00

The combination of high temperature and high pressure could reduce the hose life.
The maximum working pressures shown in the table are for service up to a maximum temperature of 100 °C.
For use at higher temperatures, consult the pressure/temperature curve in section A for the reduced maximum working pressure.

Hose layline example

PARKER 213-16 WP 2,8 MPa (400 PSI) 22 mm [7/8] 3Q88 ————— PARKER 213-16 WP 2,8

221FR

No-Skive Fire Retardant

Marine fuel and engine hose

Primary Applications

Marine: Marine fuel hose
General: Where fire retardance is an issue

Type Approvals

Details please find on pages **Ab-16** to **Ab-19**

Applicable Specifications

SAE J1527 R3, USCG Type AI, SAE J1942, ISO 7840

Construction

Inner tube: Fuel and oil-resistant rubber
Reinforcement: One high-tensile steel wire braid
Cover: Flame retardant special fibre outer cover

Temperature Range -20 °C up to +100 °C

Exception: Air max. +70 °C
Water max. +85 °C



- Fire retardant hose cover
- **No-Skive** hose construction
- Marine approvals

Recommended Fluids

Petroleum based hydraulic fluids, water-glycol and water-oil emulsion hydraulic fluids, grease, lubricants, crude, fuel oils and water.

Consult the chemical compatibility section on pages **Ab-26** to **Ab-34** for more detailed information.

Fitting Series



Part Number	Hose I.D.			Hose O.D. mm	Pressure Rating				Vacuum* kPa	min. bend radius mm	weight kg
	Inch	Size	mm		max. working pressure		min. burst pressure				
					MPa	psi	MPa	psi			
221FR-5	1/4	-5	6.3	15	3.5	500	14.0	2000	81	25	0.28
221FR-6	5/16	-6	8.0	17	3.5	500	14.0	2000	81	30	0.34
221FR-8	13/32	-8	10.0	20	3.5	500	14.0	2000	81	45	0.42
221FR-10	1/2	-10	12.5	23	3.5	500	14.0	2000	68	55	0.58
221FR-12	5/8	-12	16.0	27	3.5	500	14.0	2000	68	70	0.61
221FR-16	7/8	-16	22.0	31	3.5	500	14.0	2000	68	90	0.70

* The vacuum values listed in the table are vacuum pressure values in kPa. For an absolute value subtract the table value from 101kPa. The combination of high temperature and high pressure could reduce the hose life.

Hose layline example

PARKER 221FR-10 SAE J1527 USCG TYPE A1 CE 1085 ISO 7840-A1 WITH 26 SERIES CRIMP FITTINGS ONLY

244

Air Conditioning and Refrigeration

SAE J2064 B Class I



- Excellent effusion rate
- Long service life
- Resists moisture ingress

Primary Applications

For bus- and train applications

Applicable Specifications

SAE J2064 B Class I

Construction

Inner tube: Butyl Gummi
Reinforcement: One high-tensile steel wire braid
Cover: Fibre braid

Recommended Fluids

For use with Freon refrigerants 12, 134a and 22.
Consult the chemical compatibility section on pages **Ab-26** to **Ab-34** for more detailed information.

Temperature Range -30 °C up to +125 °C

Fitting Series



Part Number	Hose I.D.			Hose O.D. mm	Pressure Rating				Vacuum* kPa	min. bend radius mm	weight kg
	Inch	Size	mm		max. working pressure MPa	psi	min. burst pressure MPa	psi			
244-16	7/8	16	22	31	3.5	500	14	2000	95	190	0.76
244-20	1-1/8	20	29	38	3.5	500	14	2000	95	230	0.83
244-24	1-3/8	24	35	44	2.4	350	9.6	1400	95	270	0.92

* The vacuum values listed in the table are vacuum pressure values in kPa. For an absolute value subtract the table value from 101kPa. The combination of high temperature and high pressure could reduce the hose life.

Hose layline example



285

Air Conditioning and Refrigeration

SAE J2064 Type C, Class 1



- *No-Skive* hose construction
- Usable for main refrigerant fluids
- Compatible with modern refrigerants

Primary Applications

Air Conditioning: For industrial and mobile applications

Applicable Specifications

SAE J2064 Type C, Class 1

Construction

Inner tube: Nylon barrier between two elastomeric layers
 Reinforcement: One textile braid
 Cover: Heat, moisture and ozone resistant rubber

Recommended Fluids

For use with Freon refrigerants 12, 134a and 22.
 Consult the chemical compatibility section on pages **Ab-26** to **Ab-34** for more detailed information.

Temperature Range -30 °C up to +125 °C

Fitting Series



Part Number	Hose I.D.			Hose O.D. mm	Pressure Rating				Vacuum* kPa	min. bend radius mm	weight kg
	Inch	Size	mm		max. working pressure MPa	psi	min. burst pressure MPa	psi			
285-4-RL	3/16	-4	5.0	12.4	3.4	500	17.2	2500	95	25	0.14
285-6-RL	5/16	-6	8.0	15.7	3.4	500	17.2	2500	95	38	0.19
285-8-RL	13/32	-8	10.0	18.8	3.4	500	17.2	2500	95	51	0.25
285-10-RL	1/2	-10	12.5	21.1	3.4	500	17.2	2500	95	64	0.27
285-12-RL	5/8	-12	16.0	24.4	3.4	500	17.2	2500	95	76	0.34

* The vacuum values listed in the table are vacuum pressure values in kPa. For an absolute value subtract the table value from 101kPa.
 For size -16 a hose 285-16 is available on request.
 RL = only available on reels.

Hose layline example

PARKER 285-10 WP 3,4 MPa (500 PSI) SAE J2064 TYPE C CLASS I 12,5 mm (1/2) 10-4Q09

293

No-Skive High Temperature

Engine and air brake/truck hose

Primary Applications

Truck Market: Air brake hose
Engine cooling circuit

Type Approvals

Details please find on pages **Ab-16** to **Ab-19**

Applicable Specifications

SAE J1402AI, D.O.T. FMVSS 106

Construction

Inner tube: PKR synthetic rubber
Reinforcement: One fibre braid
Cover: Black nylon braid

Temperature Range -50 °C up to +150 °C

Exception: Air max. +100 °C
Water max. +85 °C



- High temperature
– high flex hose performance
- **No-Skive** hose construction
- Wide temperature range

Recommended Fluids

Petroleum-based hydraulic fluids and lubrication oils, diesel fuels and antifreeze solutions; water-, water-oil- and water-glycol emulsion hydraulic fluids. Consult the chemical compatibility section on pages **Ab-26** to **Ab-34** for more detailed information.

Fitting Series



Part Number	Hose I.D.			Hose O.D. mm	Pressure rating				min. bend radius mm	weight kg
	Inch	Size	mm		max. working pressure		min. burst pressure			
					MPa	psi	MPa	psi		
293-4-RL	3/16	-4	5.0	12.5	3.5	500	13.8	2000	15	0.15
293-6-RL	5/16	-6	8.0	15.7	3.5	500	13.8	2000	25	0.22
293-8-RL	13/32	-8	10.0	18.7	3.5	500	13.8	2000	40	0.27
293-10-RL	1/2	-10	12.5	21.1	3.1	450	12.4	1800	50	0.30
293-12-RL	5/8	-12	16.0	24.3	3.1	450	12.4	1800	65	0.33
293-16-RL	7/8	-16	22.0	30.6	3.1	450	12.4	1800	80	0.37

The combination of high temperature and high pressure could reduce the hose life.
RL = only available on reels.

Hose layline example



611HT

No-Skive

High-temperature textile hose

Primary Applications

General Market: Low pressure hydraulic applications/
high temperature applications

Engine Applications:

Diesel fuel lines, engine cooling circuits

Type Approvals

Details please find on pages **Ab-16** to **Ab-19**

Applicable Specifications

EN 854-R6

Construction

Inner tube: PKR synthetic rubber

Reinforcement: One fibre braid

Cover: MSHA approved synthetic rubber

Temperature Range -40 °C up to +150 °C

Exception: Air max. +100 °C

Water max. +85 °C

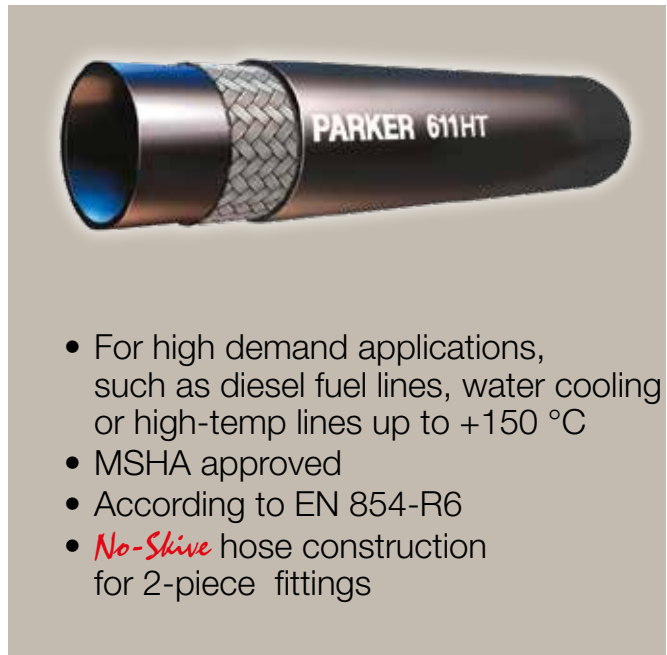

- For high demand applications, such as diesel fuel lines, water cooling or high-temp lines up to +150 °C
- MSHA approved
- According to EN 854-R6
- *No-Skive* hose construction for 2-piece fittings

Recommended Fluids

Petroleum-based hydraulic fluids and lubrication oils, diesel fuels and antifreeze solutions; water-glycol and water-oil emulsion, air and water.

Consult the chemical compatibility section on pages **Ab-26** to **Ab-34** for more detailed information.

Fitting Series

- Compatible with 2-piece fittings for use with adjustable crimpers only (47 series nipple and 10064 series shell)

Part Number	Hose I.D.				Hose O.D. mm	Pressure Rating				min. bend radius mm	weight kg
	DN	Inch	Size	mm		max. working pressure MPa	psi	min. burst pressure MPa	psi		
611HT-4	6	1/4	-4	6.4	12.8	2.8	400	11.2	1600	65	0.13
611HT-5	8	5/16	-5	7.9	14.6	2.8	400	11.2	1600	70	0.15
611HT-6	10	3/8	-6	9.5	16.0	2.8	400	11.2	1600	75	0.16
611HT-8	12	1/2	-8	12.7	20.0	2.8	400	11.2	1600	100	0.27
611HT-10	16	5/8	-10	15.9	23.2	2.4	350	9.6	1400	125	0.28
611HT-12	19	3/4	-12	19.1	26.2	2.1	300	8.4	1200	150	0.36
611HT-16	25	1	-16	25.4	33.1	2.0	290	8.0	1160	200	0.46

The combination of high temperature and high pressure could reduce the hose life.

Hose layline example

PARKER 611HT-4 HI-TEMP WP 2,8 MPa (400 PSI) MSHA IC-40/10 I • • SAE 100R6-4 6,3 mm (1/4) X 1F EN854/R6/

681

No-Skive 2TE

EN 854-2TE



- One layer of fabric braid
- *No-Skive* hose construction
- Small bend radii

Primary Applications

General Market: Low pressure hydraulic application

Applicable Specifications

EN 854-2TE

Construction

Inner tube: Synthetic rubber

Reinforcement: One fibre braid

Cover: Synthetic rubber

Temperature Range -40 °C up to +100 °C

Exception: Air max. +70 °C

Water max. +85 °C

Recommended Fluids

Petroleum based hydraulic fluids, water-glycol and water-oil emulsion hydraulic fluids, grease, lubricants, crude and fuel oils, air and water.

Consult the chemical compatibility section on pages **Ab-26** to **Ab-34** for more detailed information.

Fitting Series

- Compatible with 2-piece fittings for use with adjustable crimpers only (47 series nipple and 10064 series shell)

Part Number	Hose I.D.				Hose O.D. mm	Pressure Rating				min. bend radius mm	weight kg
	DN	Inch	Size	mm		max. working pressure MPa	psi	min. burst pressure MPa	psi		
681-4	6	1/4	-4	6.4	13.6	7.5	1090	30.0	4360	40	0.15
681-5	8	5/16	-5	7.9	14.8	6.8	980	27.0	3920	50	0.16
681-6	10	3/8	-6	9.5	16.6	6.3	910	25.0	3640	60	0.19
681-8	12	1/2	-8	12.7	19.6	5.8	840	23.0	3360	70	0.24
681-10	16	5/8	-10	15.9	23.9	5.0	725	20.0	2900	90	0.35
681-12	19	3/4	-12	19.1	27.0	4.5	650	18.0	2600	110	0.39
681-16	25	1	-16	25.4	34.4	4.0	580	16.0	2320	150	0.59

The combination of high temperature and high pressure could reduce the hose life.

Hose layline example

PARKER 681-4 WP 7,5 MPa (1090 PSI) | • • 6,3 mm (1/4) EN854/2TE/6/DIN made in Italy

681DB

No-Skive 2TE

EN 854-2TE

(with approvals for rail transportation)

Primary Applications

General Market: Low pressure hydraulic application

Rail Transportation Market:

Hydraulic applications around
train vehicles

Type Approvals

Details please find on pages **Ab-16** to **Ab-19**

Applicable Specifications

EN 854-2TE

Construction

Inner tube: Synthetic rubber

Reinforcement: One fibre braid

Cover: Flame retardant synthetic rubber

Temperature Range -40 °C up to +100 °C

Exception: Air max. +70 °C

Water max. +85 °C



- One layer of fabric braid
- **No-Skive** hose construction
- Small bend radii
- Flame retardant rubber cover
- Railway approved:
 - European Standard EN45545 HL2 for R22 (internal) and R23 (external)
 - ISO 15540 (FS-F-Fire Sleeve needed)

Recommended Fluids

Petroleum based hydraulic fluids, water-glycol and water-oil emulsion hydraulic fluids, grease, lubricants, crude and fuel oils, air and water.

Consult the chemical compatibility section on pages **Ab-26** to **Ab-34** for more detailed information.

Fitting Series

- Compatible with 2-piece fittings for use with adjustable crimpers only (47 series nipple and 10064 series shell)

Part Number	Hose I.D.				Hose O.D. mm	Pressure Rating				min. bend radius mm	weight kg
	DN	Inch	Size	mm		max. working pressure		min. burst pressure			
						MPa	psi	MPa	psi		
681DB-4	6	1/4	-4	6.4	13.6	7.5	1090	30.0	4360	40	0.15
681DB-5	8	5/16	-5	7.9	14.8	6.8	980	27.0	3920	50	0.16
681DB-6	10	3/8	-6	9.5	16.6	6.3	910	25.0	3640	60	0.19
681DB-8	12	1/2	-8	12.7	19.6	5.8	840	23.0	3360	70	0.24
681DB-10	16	5/8	-10	15.9	23.9	5.0	725	20.0	2900	90	0.35
681DB-12	19	3/4	-12	19.1	27.0	4.5	650	18.0	2600	110	0.39
681DB-16	25	1	-16	25.4	34.4	4.0	580	16.0	2320	150	0.59

The combination of high temperature and high pressure could reduce the hose life.

Hose layline example

PARKER 681DB-6 WP 6,3 MPa (910 PSI) 1" 10 mm (3/8) EN854/2TE/10/DIN MADE IN ITALY

DIN – Metric

Page B2b-1 – B2b-2

<p>CA B2b-1 Female Metric 24° Light Series with O-Ring Swivel – Straight ISO 12151-2-SWS-L – DKOL</p> 	<p>CE B2b-1 Female Metric 24° Light Series with O-Ring Swivel – 45° Elbow ISO 12151-2-SWE-L – DKOL 45°</p> 	<p>CF B2b-2 Female Metric 24° Light Series with O-Ring Swivel – 90° Elbow ISO 12151-2-SWE-L – DKOL 90°</p> 	<p>49 B2b-2 Metric Banjo Straight DIN 7642</p> 
--	---	--	---

SAE

Page B2b-3 – B2b-5

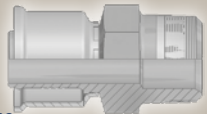
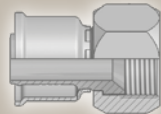
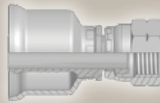
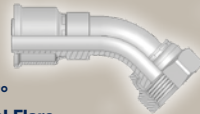
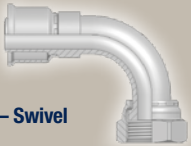
<p>01 B2b-3 Male NPTF Pipe Rigid – Straight SAE J476A / J516 – AGN</p> 	<p>06/68 B2b-3 Female – JIC 37° SAE 45° Dual Flare Swivel – Straight ISO12151-5-SWS – DKJ</p> 	<p>08 B2b-4 Female SAE 45° – Swivel Straight SAE J516</p> 	<p>37/3V B2b-4 Female JIC 37° SAE 45° – Dual Flare Swivel Female 45° Elbow ISO 12151-5-SWE 45° – DKJ 45°</p> 
<p>39 B2b-5 Female JIC 37° – Swivel 90° Elbow ISO 12151-5-SWES – DKJ 90°</p> 			

ORFS

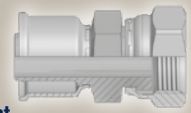

Page B2b-6

JC
B2b-6
Female ORFS
Swivel – Straight
Short
ISO 12151-1 – SWSA SAE J516 – ORFS

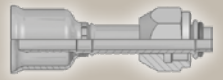

Others

Page B2b-7

<p>5S B2b-7 Female Tube O-ring Swivel Short Pilot</p> 	<p>5T B2b-7 Female Tube O-Ring Swivel 90° Elbow – Short Pilot</p> 
--	--

CA **Female Metric 24°
Light Series with O-Ring
Swivel – Straight**
ISO 12151-2-SWS-L – DKOL

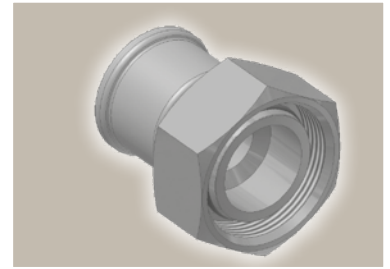
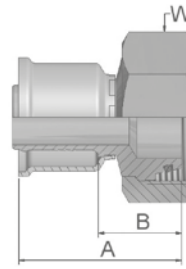

Part Number	Hose I.D.			Thread metric	Tube O.D. mm	A mm	B mm	W mm
	Inch	Size	mm					
1CA26-8-4	3/16	-4	5.0	M14x1.5	8	42	21	17
1CA26-10-5	1/4	-5	6.3	M16x1.5	10	41	20	19
1CA26-10-6	5/16	-6	8.0	M16x1.5	10	41	20	19
1CA26-12-6	5/16	-6	8.0	M18x1.5	12	42	21	22
1CA26-12-8	13/32	-8	10.0	M18x1.5	12	42	21	22
1CA26-15-8	13/32	-8	10.0	M22x1.5	15	42	22	27
1CA26-18-10	1/2	-10	12.5	M26x1.5	18	46	23	32
1CA26-18-12	5/8	-12	16.0	M26x1.5	18	46	23	32
1CA26-22-12	5/8	-12	16.0	M30x2	22	48	25	36
1CA26-28-16	7/8	-16	22.0	M36x2	28	54	28	41
1CA26-28-20	1 1/8	-20	29.0	M36x2	28	61	33	41
1CA26-35-20	1 1/8	-20	29.0	M45x2	35	56	29	50
1CA26-35-24	1 3/8	-24	35.0	M45x2	35	62	34	50
1CA26-42-24	1 3/8	-24	35.0	M52x2	42	59	31	60

Hose fittings are delivered with ozone resistant Nitrile (NBR) O-ring as a standard version. Working temperature from -40 °C up to +105 °C.
Hose fittings with special O-rings (Viton or EPDM) available on request. O-ring dimensions and part-numbers see in section Eb.

CE **Female Metric 24°
Light Series with O-Ring
Swivel – 45° Elbow**
ISO 12151-2-SWE -L – DKOL 45°

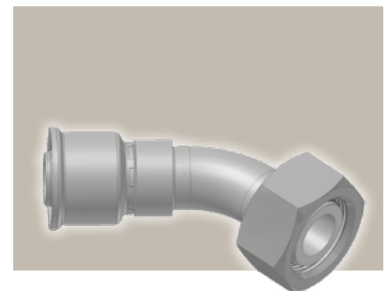
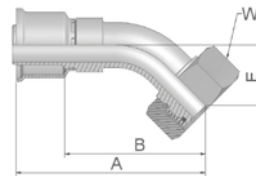

Part Number	Hose I.D.			Thread metric	Tube O.D. mm	A mm	B mm	E mm	W mm
	Inch	Size	mm						
1CE26-10-6	5/16	-6	8.0	M16x1.5	10	67	46	18	19
1CE26-12-6	5/16	-6	8.0	M18x1.5	12	66	46	18	22
1CE26-12-8	13/32	-8	10.0	M18x1.5	12	61	40	17	22
1CE26-15-8	13/32	-8	10.0	M22x1.5	15	60	40	17	27
1CE26-18-10	1/2	-10	12.5	M26x1.5	18	68	46	20	32
1CE26-18-12	5/8	-12	16.0	M26x1.5	18	73	50	22	32
1CE26-22-12	5/8	-12	16.0	M30x2	22	77	55	26	36
1CE26-28-16	7/8	-16	22.0	M36x2	28	105	78	33	41

Hose fittings are delivered with ozone resistant Nitrile (NBR) O-ring as a standard version. Working temperature from -40 °C up to +105 °C.
Hose fittings with special O-rings (Viton or EPDM) available on request. O-ring dimensions and part-numbers see in section Eb.

Approved **fitting series** for hose types:



CF **Female Metric 24°
Light Series with O-Ring
Swivel – 90° Elbow**
ISO 12151-2-SWE-L – DKOL 90°

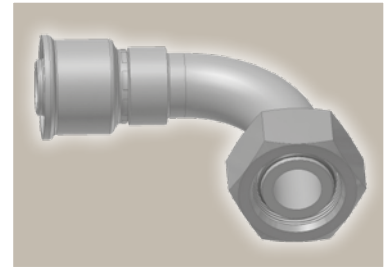
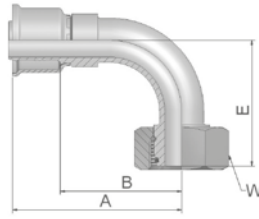

Part Number	Hose I.D.			Thread metric	Tube O.D. mm	A mm	B mm	E mm	W mm
	Inch	Size	mm						
1CF26-8-4	3/16	-4	5.0	M14x1.5	8	45	24	29	17
1CF26-10-5	1/4	-5	6.3	M16x1.5	10	55	36	30	19
1CF26-10-6	5/16	-6	8.0	M16x1.5	10	55	34	32	19
1CF26-12-6	5/16	-6	8.0	M18x1.5	12	56	35	36	22
1CF26-12-8	13/32	-8	10.0	M18x1.5	12	50	30	32	22
1CF26-15-8	13/32	-8	10.0	M22x1.5	15	58	38	42	27
1CF26-18-10	1/2	-10	12.5	M26x1.5	18	57	34	38	32
1CF26-18-12	5/8	-12	16.0	M26x1.5	18	69	46	45	32
1CF26-22-12	5/8	-12	16.0	M30x2	22	78	55	47	36
1CF26-18-16	7/8	-16	22.0	M26x1.5	18	92	65	70	32
1CF26-28-16	7/8	-16	22.0	M36x2	28	96	70	71	41
1CF26-28-20	1 1/8	-20	29.0	M36x2	28	117	90	81	41
1CF26-35-20	1 1/8	-20	29.0	M45x2	35	117	90	77	50
1CF26-35-24	1 3/8	-24	35.0	M45x2	35	117	89	79	50

Hose fittings are delivered with ozone resistant Nitrile (NBR) O-ring as a standard version. Working temperature from -40 °C up to +105 °C.
Hose fittings with special O-rings (Viton or EPDM) available on request. O-ring dimensions and part-numbers see in section Eb.

49 **Metric Banjo
Straight**
DIN 7642

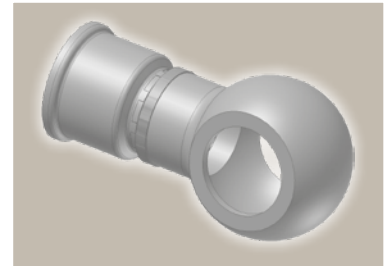
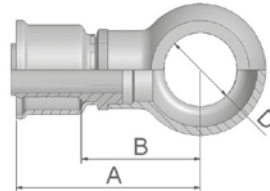

Part Number	Hose I.D.			A mm	B mm	D mm
	Inch	Size	mm			
14926-12-6	5/16	-6	8.0	47	26	12
14926-14-6	5/16	-6	8.0	49	28	14
14926-14-8	13/32	-8	10.0	48	28	14
14926-16-8	13/32	-8	10.0	50	30	16

Approved **fitting series** for hose types:

26 201 206 213 221FR 244 285 293

01

Male NPTF Pipe Rigid – Straight

SAE J476A/ J516 – AGN

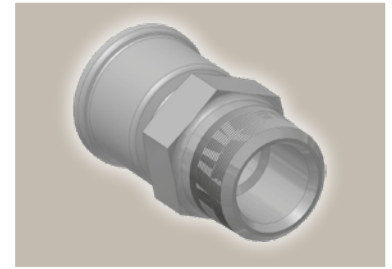
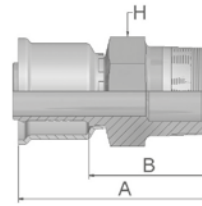

Part Number	Hose I.D.			Thread NPTF	A mm	B mm	H Inch
	Inch	Size	mm				
10126-4-5	1/4	-5	6.3	1/4-18	48	26	9/16
10126-4-6	5/16	-6	8.0	1/4-18	48	26	3/4
10126-6-6	5/16	-6	8.0	3/8-18	48	26	11/16
10126-6-8	13/32	-8	10.0	3/8-18	48	26	11/16
10126-8-8	13/32	-8	10.0	1/2-14	54	33	7/8
10126-8-10	1/2	-10	12.5	1/2-14	57	33	7/8
10126-12-12	5/8	-12	16.0	3/4-14	59	35	1 1/16

26 Series

06/68

Female – JIC 37° SAE 45° Dual Flare Swivel – Straight

ISO12151-5-SWS – DKJ

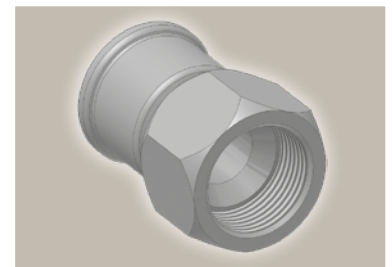
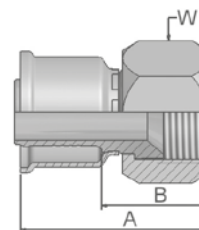

Part Number	Hose I.D.			Thread UNF	Tube mm	A mm	B mm	W mm Inch
	Inch	Size	mm					
16826-4-4	3/16	-4	5.0	7/16x20	1/4	42	20	9/16
16826-5-5BA	1/4	-5	6.3	1/2x20	5/16	45	23	5/8
10626-6-6	5/16	-6	8.0	9/16x18	3/8	45	23	11/16
10626-6-6BS	5/16	-6	8.0	9/16x18	3/8	45	23	11/16
16826-8-8	13/32	-8	10.0	3/4x16	1/2	49	27	7/8
16826-8-10	1/2	-10	12.5	3/4x16	1/2	60	36	7/8
16826-10-10	1/2	-10	12.5	7/8x14	5/8	55	31	1
16826-10-10BA	1/2	-10	12.5	7/8x14	5/8	55	31	1
16826-10-12	5/8	-12	16.0	7/8x14	5/8	61	37	1
10626-12-12	5/8	-12	16.0	1 1/16x12	3/4	58	34	1 1/4
10626-16-16	7/8	-16	22.0	1 5/16x12	1	64	38	1 1/2
10626-20-20	1 1/8	-20	29.0	1 5/8x12	1 1/4	65	38	2
10626-24-24	1 3/8	-24	35.0	1 7/8x12	1 1/2	70	43	2 1/4
10626-32-32	1 13/16	-32	46.0	2 1/2x12	2	84	52	2 7/8

Approved fitting series for hose types: BA: Nipple: Brass, Nut and Shell: Steel; BS: Nipple and Nut: Brass, Shell: Steel; SM: Metric Hexagon

26 201 206 213 221FR 244 285 293

08 Female SAE 45° – Swivel Straight

SAE J516

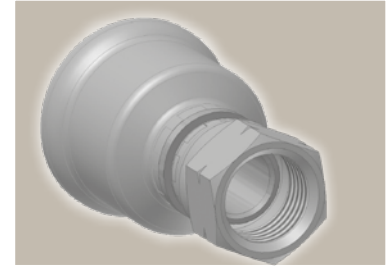
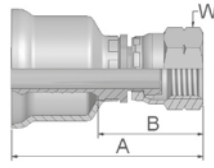

Part Number	Hose I.D.			Thread UNF	Tube mm	A mm	B mm	W Inch
	Inch	Size	mm					
10826-6-6	5/16	-6	8.0	5/8x18	3/8	47	25	3/4
10826-6-6BA	5/16	-6	8.0	5/8x18	3/8	47	25	3/4
10826-12-12	5/8	-12	16.0	1 1/16x14	3/4	56	32	1 1/4

37/3V Female JIC 37° SAE 45° – Dual Flare Swivel Female 45° Elbow

ISO 12151-5-SWE 45° – DKJ 45°

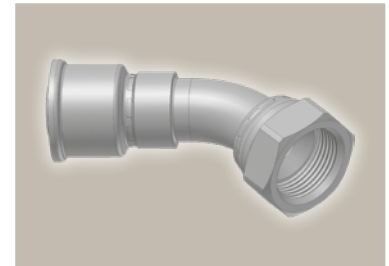
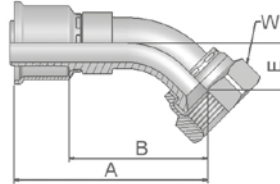

Part Number	Hose I.D.			Thread UNF	Tube mm	A mm	B mm	E mm	W mm Inch
	Inch	Size	mm						
13726-4-4	3/16	-4	5.0	7/16x20	-	51	29	10	9/16
13726-6-6	5/16	-6	8.0	9/16x18	3/8	69	47	11	11/16
13726-8-8	13/32	-8	10.0	3/4x16	-	72	50	15	7/8
13V26-10-10	1/2	-10	12.5	7/8x14	5/8	69	44	17	1
13726-12-12	5/8	-12	16.0	1 1/16x12	3/4	87	63	21	1 1/4
13726-16-16	7/8	-16	22.0	1 5/16x12	1	85	58	23	1 1/2

Approved **fitting series** for hose types:

BA: Nipple: Brass, Nut and Shell: Steel

26 201 206 213 221FR 244 285 293

39 Female JIC 37° – Swivel 90° Elbow

ISO 12151-5-SWES – DKJ 90°

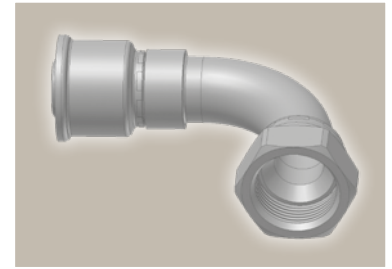
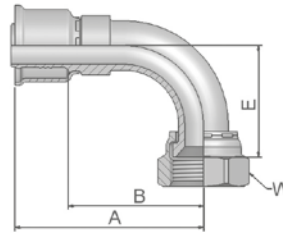

Part Number	Hose I.D.			Thread UNF	Tube mm	A mm	B mm	E mm	W mm
	Inch	Size	mm						
13926-4-4	3/16	-4	5.0	7/16x20	-	46	24	21	9/16
13926-6-6	5/16	-6	8.0	9/16x18	3/8	55	24	21	9/16
13926-8-8	13/32	-8	10.0	3/4x16	-	56	35	28	7/8
13926-10-10	1/2	-10	12.5	7/8x14	-	57	33	32	1
13926-10-12	5/8	-12	16.0	7/8x14	-	64	40	31	1
13926-12-12	5/8	-12	16.0	1 1/16x12	-	58	34	46	1 1/4
13926-16-16	7/8	-16	22.0	1 5/16x12	1	84	57	54	1 1/2
13926-20-20	1 1/8	-20	29.0	1 5/8x12	1 1/4	91	67	65	2

26 Series

Approved **fitting series** for hose types:

26	201	206	213	221FR	244	285	293
----	-----	-----	-----	-------	-----	-----	-----

JC **Female ORFS**
Swivel – Straight
Short

ISO 12151-1 – SWSA
SAE J516 – ORFS

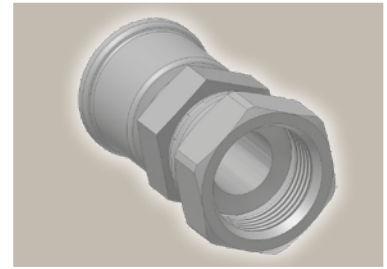
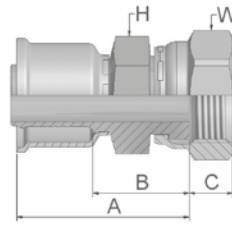

Part Number	Hose I.D.			Thread UNF	A mm	B mm	C mm	H mm	W mm
	Inch	Size	mm						
1JC26-4-4	3/16	-4	5.0	9/16x18	42	20	8	-	11/16
1JC26-6-6	5/16	-6	8.0	11/16x16	43	21	9	-	13/16
1JC26-8-8	13/32	-8	10.0	13/16x16	45	23	11	-	15/16
1JC26-10-10	1/2	-10	12.5	1x14	55	31	13	15/16	1 1/8
1JC26-12-12	5/8	-12	16.0	1 3/16x12	54	30	14	-	1 3/8
1JC26-16-16	7/8	-16	22.0	1 7/16x12	61	34	14	1 3/8	1 5/8
1JC26-20-20	1 1/8	-20	29.0	1 11/16x12	62	35	15	1 7/8	1 7/8

Approved **fitting series** for hose types:

26 201 206 213 221FR 244 285 293

5S Female Tube O-ring Swivel Short Pilot

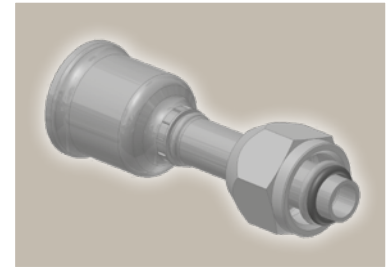
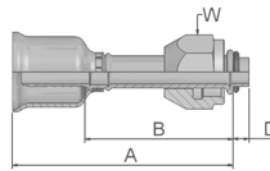

Part Number	Hose I.D.			Thread UNF	A mm	B mm	D mm	W Inch
	Inch	Size	mm					
15S26-6-6	5/16	-6	8.0	5/8x18	66	44	4.7	3/4
15S26-8-8	13/32	-8	10.0	3/4x16	67	45	4.7	7/8
15S26-10-10	1/2	-10	12.5	7/8x14	71	47	4.7	1 1/16
15S26-10-12	5/8	-12	16.0	7/8x14	71	47	4.7	1 1/16

5T Female Tube O-Ring Swivel 90° Elbow – Short Pilot

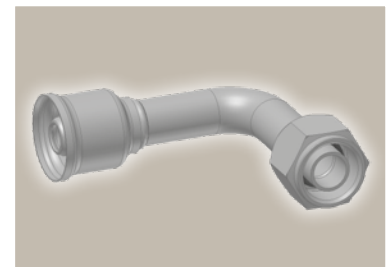
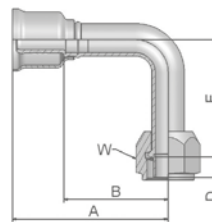

Part Number	Hose I.D.			Thread UNF	A mm	B mm	D mm	E mm	W Inch
	Inch	Size	mm						
15T26-6-6	5/16	-6	8.0	5/8x18	56	34	4.7	36	3/4
15T26-8-8	13/32	-8	10.0	3/4x16	63	41	4.7	37	7/8
15T26-10-10	1/2	-10	12.5	7/8x14	73	49	4.7	44	1 1/16

Approved **fitting series** for hose types:

26 201 206 213 221FR 244 285 293



Hydraulic Hoses and Fittings

Medium Pressure



ENGINEERING YOUR SUCCESS.

Medium Pressure Hoses and Fittings

The perfect range for the more demanding market requirements

This medium pressure hose range contains the Elite No-Skive compact hydraulic hoses exceeding ISO and EN specifications and the classic No-Skive hydraulic hoses according to ISO, EN and SAE specifications. This hose range is complemented by a full selection of compatible No-Skive fittings in steel and stainless steel.

- **Extended range** of working temperatures:
-50 °C up to +150 °C
- Selected hoses feature **nitrile inner tubes** suitable for mineral and bio-degradable oils
- Full range of **fluid compatibility**; oil, water, phosphate ester etc.



- Using **high quality compounds** allows thin covers – less weight – long service life still assured
- **High flexibility** for easier installation and increased service life
- **Small bend radii** and **light weight** for applications where space and weight are determining factors
- High **abrasion resistance** hose covers superior to ISO 6945 requirements, extending service life
- High **ozone-resistant** cover compounds extending weathering and ageing resistance
- **Parkrimp** machines, portable or bench mount for easy assembly operation – hose assemblies meet CE directives
- Complete **No-Skive fitting technology** across the full range of medium pressure hoses providing simpler, quicker and safer hose assembly



Applications

The definitive hose range for all medium-pressure applications



Parkrimp® *No-Skive*

The system for fast and leak-free assemblies

The perfect match



Parker's colour-coded die sets

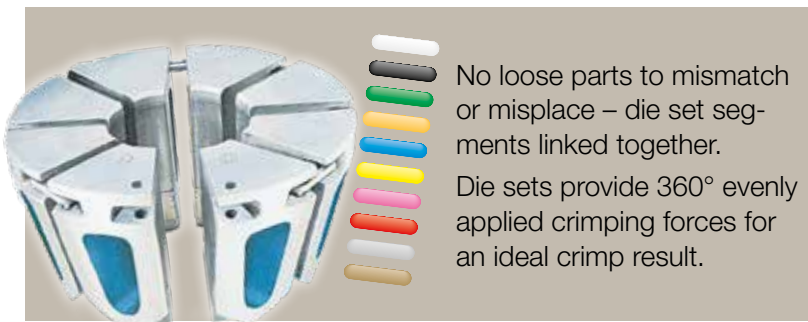

Parkalign®



Parkrimp® *No-Skive*

- No skiving tool needed
- No need to remove the cover
- Crimps one-piece fittings
- Parkalign positions the fittings in the dies perfectly every time
- Quick and easy: no gauges to set on the machine
- Portable machines for field repair
- Meets EN safety regulations

Good – Better – Best – engineered for your success.

New classification for easier hose and fitting selection

Good

“Good” hoses are cost-effective products – fully meeting the main parameters of the traditional international standards and exceeding them in particular requirements, such as service life, appearance, environmental aspects etc. (BCH braided hoses in combination with fitting series 46 and 48 and in the high pressure range SX spiral hoses with fittings series 73 and 77).

Good

Medium Pressure

BCH1, BCH2

Fitting Series



Better

The category “Better” includes hose products which are exceeding the traditional international standards in the main parameters, such as working pressure, temperature, flexibility, impulse pressure resistance etc. These are the main qualities appreciated by the customers at the Parker well known *No-Skive* hoses – *Elite* braided and in the high pressure range Parkrimp spiral.

Better

Medium Pressure

Elite 462, 492

Fitting Series



Best

Category “Best” contains GLOBALCORE hose products which are meeting or even exceeding the latest and most demanding International Standard ISO 18752. GLOBALCORE is the world’s first high performance, cohesive hose and fitting range. GLOBALCORE hoses have constant working pressures of 21.0 or 28.0 MPa and in the high pressure range 35.0 or 42.0 MPa.

Best

Medium Pressure

GLOBALCORE™

387, 487

Fitting Series



Good

Newly developed high performance *No-Skive* hoses

BCH braided hoses – meeting international technical standards, newly developed for demanding small and medium OEMs and general distribution.

BCH1

EN 857 1SC - ISO 11237



Size -4 up to -16
-40 °C up to +100 °C

Working pressure up to 22.5 MPa



NO-SKIVE BCH1-6 WP 18.0 MPa (2610 PSI) | •• 10 mm

BCH2

EN 857 2SC - ISO 11237



Size -4 up to -16
-40 °C up to +100 °C

Working pressure up to 40.0 MPa



NO-SKIVE BCH2-6 WP 33 MPa (4800 PSI) | •• 10 mm

Customers choice is the key

Good, Better, Best classification for easier hose and fitting selection

- Different levels for different markets and applications
- Help customers to make better buying decision
- Defined hose and fitting combination on hose layline
- Clear visibility of correct fitting
- Easy to understand
- Ensures quality of hose and fitting combination

Superior performance of Best hoses versus Better and Good hoses

- Bend radius up to 50% smaller
- Flexibility (bending force) up to 30% higher
- Weight up to 20% lower
- Dimensions up to 25% smaller area
- Impulse resistance and service life up to four times higher
- Working temperature up to 25% higher

Agriculture is one of the typical markets and applications where „Good hose and fittings“ are the preferred product selection.



Elite No-Skive Hoses

for reliability, performance, sustainability and prevention

Designers of hydraulic machinery are increasingly defining new products that require hydraulic circuits with tighter curves, higher pressures and less space in which to route flexible connections and achieve a solution.

The option to use flexible connections that are tested over and above the generally accepted norms and specifications and, that offer reliability and performance to the highest market standards, give peace of mind and the possibility to enhance the reputation and dependability of products developed by engineering and design departments. To meet hydraulic application demands for reliability and performance, engineers typically look at medium pressure braided hose ranges with a compact design and no-skive fittings. They often tend towards well known and established names on the market, where real-world long life and dependability have been proven.

Reliability

One of the most important factors engineers look for is reliability. In the case of a hydraulic hose line that primarily means the integrity of its connection. Hoses that use the Parker®

No-Skive technology, such as the Elite range from Parker, are the preferred choice for all medium pressure mobile and industrial applications.



Leakfree No-Skive hose assembly

Performance

Particularly challenging are applications in earth-moving and construction machinery that require higher performance from the hoses they use in terms of flexibility, a tight bending radius and resistance to very low temperatures. The Elite low temperature hose 461LT can be used in applications with an ambient temperature of down to -50 °C.



Low temperature hose 461LT

Sustainability

Sustainability is a strategy that underlines many initiatives, integrating life cycles assessment into the product development process for leading, responsible manufacturers. Transparency in the use of chemicals, processes and materials and utilising technical know-how and engineering skills are key to meet this increasingly important and globally relevant requirements.



Elite No-Skive Hoses

with outstanding technical properties



Chrome6-free fittings

Prevention

High performance most often goes hand-in-hand with long life and reliability which translates into reduced machine downtime caused by hose assembly failure.

However, through a preventive maintenance program, unexpected, unscheduled and costly downtime can be largely avoided. A Preventive Maintenance Program may comprise regular checks of the hydraulic circuit and of all the flexible parts that compose it.

Identification systems such as the Parker Tracking System (PTS) are designed to help customers reduce vehicle or asset downtime through increases in speed, timing and accuracy of necessary repairs.

The wire braided Elite No-Skive hose range with outstanding technical properties such as superior flexibility, tighter bend radii and tough or super tough hose cover exceeds the EN specifications and meets the OEM and MRO requirements of today and tomorrow!

The range also includes a new chlorine-free hose type with a smooth pure nitrile inner tube – a hose which is environmentally friendly from production to disposal and that with an excellent chemical resistance.



Exceeds European specifications

- higher abrasion resistance
- higher pressure ratings



Long service life achieved through implementing

- nitrile inner tubes for better fluid compatibility
- tested and approved hose and fitting combinations

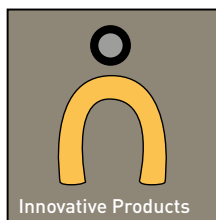

innovative product line with excellent technical characteristics

- high flexibility
- tight bending radii
- compact thin cover hoses
- No-Skive technology

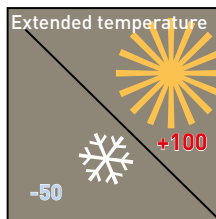

temperature range

- up to +125 °C
- down to -50 °C for low temperature (LT) hoses

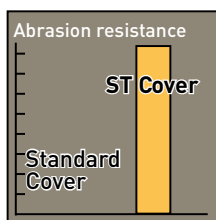

extreme abrasion resistance

- > 1 Mio cycles with ST cover according to ISO 6945 (which represents 450 times the standard cover)

GLOBALCORE™

The world's first high-performance, cohesive hose and fitting system

187 / 187TC / 187ST *No-Skive* GlobalCore

Meeting the demands of complex hydraulic systems and high pressure return lines

Primary Applications



Parker's GlobalCore 187 hose provides 7 MPa (1,000 psi) constant working pressure in all sizes. Available in a variety of cover options so you can match the right cover to your application, 187 hose offers you the choice of Standard, ToughCover and SuperTough.

Designed, built and tested to the ISO 18752 performance specification, Parker's 187 hose is unmatched in today's marketplace.

For high pressure return line applications in all markets.

387 / 387TC / 387ST *No-Skive* GlobalCore

Delivering value and performance for high-pressure systems

Primary Applications



Parker's GlobalCore 387 hose provides 21 MPa (3,000 psi) constant working pressure in all sizes. Available in a variety of cover options so you can match the right cover to your application, 387 hose offers you the choice of Standard, ToughCover and SuperTough. Designed, built and tested to the ISO 18752 performance specification, Parker's 387 hose is unmatched in today's marketplace.

487 / 487TC / 487ST *No-Skive* GlobalCore

Highly flexible across all sizes

Primary Applications



Parker's GlobalCore 487 hose provides 28 MPa (4,000 psi) constant working pressure in all sizes. Designed for high performance, 487 is available in a variety of cover options, including Standard, ToughCover and SuperTough. Its synthetic rubber inner tube provides a wider range of fluid compatibility. Rated to the ISO 18752 performance specification, 487 will excel in multiple applications around the world.



www.parker.com/globalcore

GlobalCore significantly reduces system complexity



- 7 MPa (1,000 psi) constant working pressure
- Exceeds ISO 18752 performance specification (AS)
- Synthetic rubber inner tube provides a wider range of fluid compatibility
- TC cover provides 80 times the abrasion resistance compared to Standard rubber cover hoses
- ST cover provides 450 times the abrasion resistance compared to Standard rubber cover hoses



- ½ ISO 18752 minimum bend radius
- Low force to flex for ease of installation
- 21 MPa (3,000 psi) constant working pressure in all sizes
- Exceeds ISO 18752 performance specification (AC, BC and CC)
- Synthetic rubber inner tube provides a wider range of fluid compatibility
- TC cover provides 80 times the abrasion resistance compared to Standard rubber cover hose
- ST cover provides 450 times the abrasion resistance compared to Standard rubber cover hose



- ½ ISO 18752 minimum bend radius
- Low force to flex for ease of installation
- 28 MPa (4,000 psi) constant working pressure in all sizes
- Exceeds ISO 18752 performance specification (AC, BC & CC)
- TC cover provides 80 times the abrasion resistance compared to Standard rubber cover hose
- ST cover provides 450 times the abrasion resistance compared to Standard rubber cover hose

Universal Push-to-Connect (UPTC)

The unique push-in system for tubes and hoses

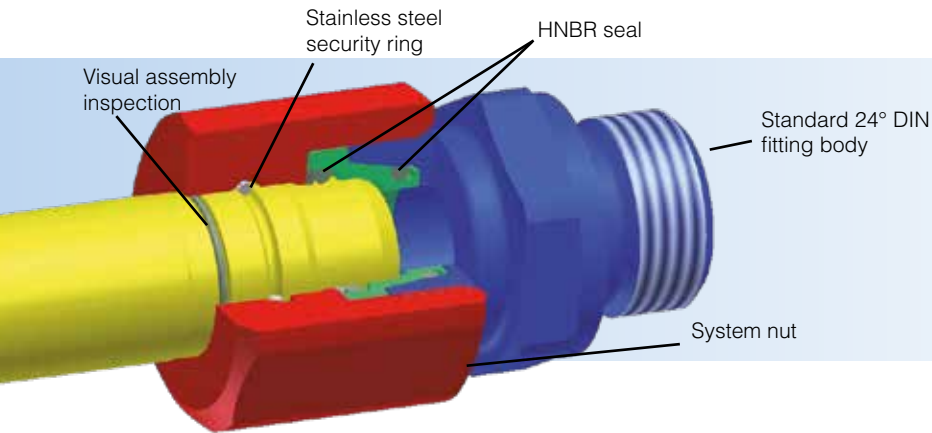

As a standard solution it's a stroke of genius

Parker's UPTC is the standardised push-in system for Parker 24° DIN fitting bodies.

In use with tube and hose

Because of its flexibility, UPTC is a unique push-in system for tube and hose terminations.

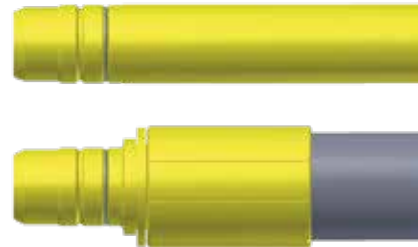

Assembly

- Simply introduce the hose or tube into the works-assembled fitting and push in.

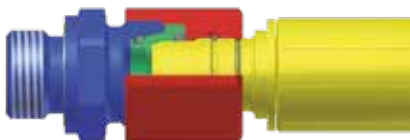

Assembled connector

Simple

- Visual assembly inspection
- Marker inside the nut = unambiguous assembly results

Safe

- Security ring locks in place
- Termination is held in the connector

Leak-proof

- Elastomeric seal
- 100 % leak-proof

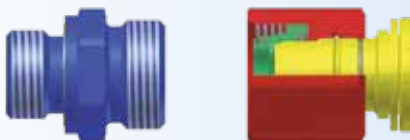

Disassembly

- Removable and fit for reassembly just like conventional screw fittings – possible even in very dirty conditions

- Repair-friendly
- No special tools required

Examples

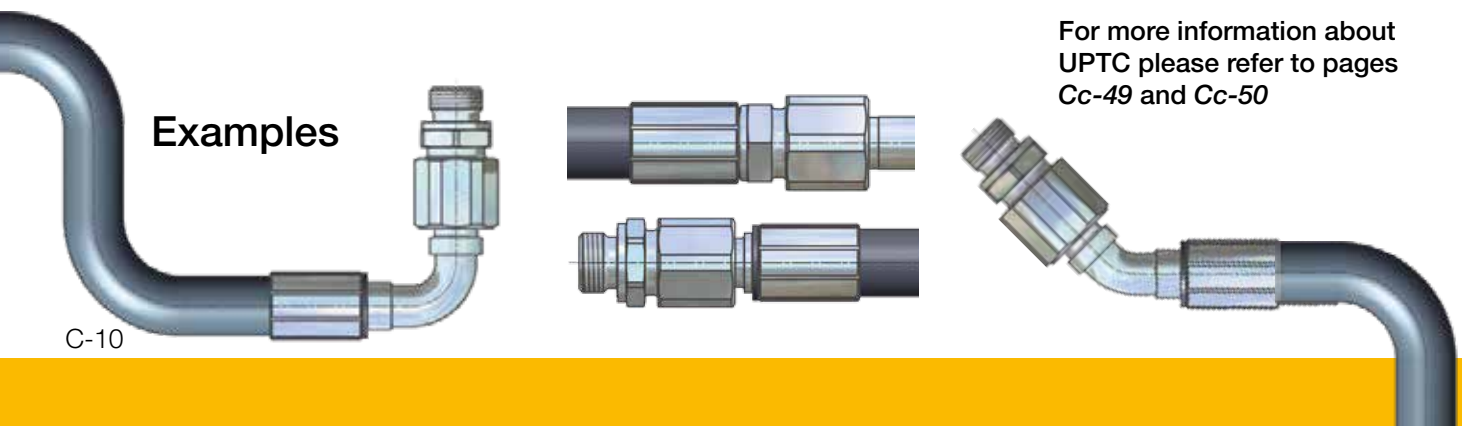

For more information about UPTC please refer to pages Cc-49 and Cc-50

Medium Pressure GLOBALCORE™

Hoses			Page
Best	187	GlobalCore	Caa-1
Best	187TC	GlobalCore	Caa-2
Best	187ST	GlobalCore	Caa-3
Best	387	GlobalCore	Caa-4
Best	387TC	GlobalCore	Caa-5
Best	387ST	GlobalCore	Caa-6
Best	487	GlobalCore	Caa-7
Best	487TC	GlobalCore	Caa-8
Best	487ST	GlobalCore	Caa-9

Fittings Series	43	46/48
Chapter	Cc	Cd
DIN – Metric	1 – 4	1 – 9
BSP	5 – 8	10 – 18
SAE	9 – 10	19 – 24
Flange	12 – 13	25 – 29
ORFS	14 – 15	30 – 35
JIS		36 – 37
Others		40
UPTC		41 – 42

Parker Hannifin assumes no liability for typographical errors or other errors

Standard

187 **Best**

Caa-1 

No-Skive GlobalCore
Exceeds ISO 18752-AS

387 **Best**

Caa-4 

No-Skive GlobalCore
Sizes -4 to -16 exceed ISO 18752-AC
Sizes -20 to -32 exceed ISO 18752-BC

487 **Best**

Caa-7 

No-Skive GlobalCore
Sizes -4 to -12 exceed ISO 18752-AC
Sizes -16 to -32 exceed ISO 18752-BC

High abrasion resistance

187TC **Best**

Caa-2 

No-Skive GlobalCore Tough Cover
Exceeds ISO 18752-AS

387TC **Best**

Caa-5 

No-Skive GlobalCore Tough Cover
Sizes -4 to -16 exceed ISO 18752-AC
Sizes -20 to -32 exceed ISO 18752-CC

487TC **Best**

Caa-8 

No-Skive GlobalCore Tough Cover
Sizes -4 to -12 exceed ISO 18752-AC
Sizes -16 to -32 exceed ISO 18752-CC

Extreme abrasion resistance

187ST **Best**

Caa-3 

No-Skive GlobalCore Super Tough
Exceeds ISO 18752-AS

387ST **Best**

Caa-6 

No-Skive GlobalCore Super Tough
Sizes -4 to -16 exceed ISO 18752-AC
Sizes -20 to -32 exceed ISO 18752-CC

487ST **Best**

Caa-9 

No-Skive GlobalCore Super Tough
Sizes -4 to -12 exceed ISO 18752-AC
Sizes -16 to -32 exceed ISO 18752-CC

187

No-Skive GlobalCore

Exceeds ISO 18752-AS

Primary Applications

Designed, build and tested to the ISO 18752 performance specifications. For high pressure return line applications in all markets.

Applicable Specifications

ISO 18752-AS

Construction

- Inner tube: Synthetic rubber
- Reinforcement: Two high-tensile steel wire braids
- Cover: Synthetic rubber

Temperature Range -40 °C up to +100 °C

- Exception: Air max. +70 °C
- Water max. +85 °C



Recommended Fluids

Hydraulic fluids on a mineral-oil basis, water-glycol and lubricating oils, air and water. For air and gas applications with a pressure exceeding 1.7 MPa, the cover must be pin-pricked. Consult the chemical compatibility section on pages **Ab-26** to **Ab-34** for more detailed information.

Fitting Series

2piece 48

Part Number	Hose I.D.				Hose O.D. mm	Pressure Rating				Vacuum* kPa	min. bend radius mm	weight kg
	DN	Inch	Size	mm		max. working pressure MPa	psi	min. burst pressure MPa	psi			
187-40	63	2 1/2	-40	63.5	75.0	7.0	1000	28.0	4000	60	508	3.04
187-48	76	3	-48	76.2	87.0	7.0	1000	28.0	4000	60	508	3.38

The combination of high temperature and high pressure could reduce the hose life.

Hose layline example



187TC

No-Skive GlobalCore Tough Cover

Exceeds ISO 18752-AS

Primary Applications

Designed, build and tested to the ISO 18752 performance specifications. For high pressure return line applications in all markets.

Applicable Specifications

ISO 18752-AS

Construction

Inner tube: Synthetic rubber
Reinforcement: Two high-tensile steel wire braids
Cover: Highly abrasion resistance
MSHA approved synthetic rubber

Temperature Range -40 °C up to +100 °C

Exception: Air max. +70 °C
Water max. +85 °C



- GlobalCore - *No-Skive*
- Synthetic rubber inner tube provides a wider range of fluid compatibility
- 7 MPa constant working pressure
- Highly abrasion resistant **TOUGH COVER**
- MSHA approved
- Hose is suitable for temporary immersion in mineral oil up to 70 °C with frequent inspections

Recommended Fluids

Hydraulic fluids on a mineral-oil basis, water-glycol and lubricating oils, air and water. For air and gas applications with a pressure exceeding 1.7 MPa, the cover must be pin-pricked. Consult the chemical compatibility section on pages **Ab-26** to **Ab-34** for more detailed information.

Fitting Series

2piece 48

Part Number	Hose I.D.				Hose O.D. mm	Pressure Rating				Vaccum* kPa	min. bend radius mm	weight kg
	DN	Inch	Size	mm		max. working pressure MPa	psi	min. burst pressure MPa	psi			
187TC-40	63	2 1/2	-40	63.5	75.0	7.0	1000	28.0	4000	60	508	3.04
187TC-48	76	3	-48	76.2	87.0	7.0	1000	28.0	4000	60	508	3.38

The combination of high temperature and high pressure could reduce the hose life.

Hose layline example



187ST

No-Skive GlobalCore Super Tough

Exceeds ISO 18752-AS

Primary Applications

Designed, build and tested to the ISO 18752 performance specifications. For high pressure return line applications in all markets.

Applicable Specifications

ISO 18752-AS

Construction

- Inner tube: Synthetic rubber
- Reinforcement: Two high-tensile steel wire braids
- Cover: Synthetic rubber with a special polyethylene coating

Temperature Range -40 °C up to +100 °C

- Exception: Air max. +70 °C
- Water max. +85 °C



- GlobalCore - *No-Skive*
- Synthetic rubber inner tube provides a wider range of fluid compatibility
- 7 MPa constant working pressure
- Extreme abrasion resistant **SUPER TOUGH** cover
- MSHA approved

Recommended Fluids

Hydraulic fluids on a mineral-oil basis, water-glycol and lubricating oils, air and water. For air and gas applications with a pressure exceeding 1.7 MPa, the cover must be pin-pricked. Consult the chemical compatibility section on pages **Ab-26** to **Ab-34** for more detailed information.

Fitting Series

2piece 48

Part Number	Hose I.D.				Hose O.D. mm	Pressure Rating				Vacuum*	min. bend radius mm	weight kg
	DN	Inch	Size	mm		max. working pressure MPa	psi	min. burst pressure MPa	psi			
187ST-40	63	2 1/2	-40	63.5	75.0	7.0	1000	28.0	4000	60	508	3.04
187ST-48	76	3	-48	76.2	87.0	7.0	1000	28.0	4000	60	508	3.38

The combination of high temperature and high pressure could reduce the hose life.

Hose layline example



387

No-Skive GlobalCore

Sizes -4 to -16 exceed ISO 18752-AC
 Sizes -20 to -32 exceed ISO 18752-BC



- GlobalCore - *No-Skive*
- 1/2 ISO 18752 minimum bend radius
- Low force to flex for ease of installation
- 21 MPa constant working pressure

Primary Applications

General medium pressure hydraulic applications

Applicable Specifications

Exceed ISO 18752-AC and ISO 18752-BC

Construction

- Inner tube: Synthetic rubber
 Reinforcement: One or two high-tensile steel wire braids (four-spiral for sizes -20 up to -32)
 Cover: Synthetic rubber

Temperature Range -40 °C up to +100 °C

- Exception: Air max. +70 °C
 Water max. +85 °C

Recommended Fluids

Hydraulic fluids on a mineral-oil basis, water-glycol and lubricating oils, air and water. For air and gas applications with a pressure exceeding 1.7 MPa, the cover must be pin-pricked. Consult the chemical compatibility section on pages **Ab-26** to **Ab-34** for more detailed information.

Fitting Series

Series 43/48 for sizes -4 up to -16

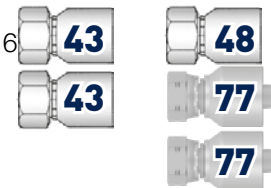

Series 43/77 for size -20

Series 77 for sizes -24 up to -32

Part Number	Hose I.D.				Hose O.D. mm	Pressure Rating				min. bend radius mm	weight kg
	DN	Inch	Size	mm		max. working pressure		min. burst pressure			
						MPa	psi	MPa	psi		
387-4	6	1/4	-4	6.4	13.4	21.0	3000	84.0	12000	50	0.24
387-6	10	3/8	-6	9.5	17.4	21.0	3000	84.0	12000	65	0.34
387-8	12	1/2	-8	12.7	20.7	21.0	3000	84.0	12000	90	0.43
387-10	16	5/8	-10	15.9	23.9	21.0	3000	84.0	12000	100	0.49
387-12	19	3/4	-12	19.1	27.8	21.0	3000	84.0	12000	120	0.86
387-16	25	1	-16	25.4	35.4	21.0	3000	84.0	12000	150	1.17
387-20	31	1 1/4	-20	31.8	46.3	21.0	3000	84.0	12000	210	2.59
387-24	38	1 1/2	-24	38.1	52.8	21.0	3000	84.0	12000	250	2.99
387-32	51	2	-32	50.8	66.2	21.0	3000	84.0	12000	320	4.09

The combination of high temperature and high pressure could reduce the hose life.

Hose layline example

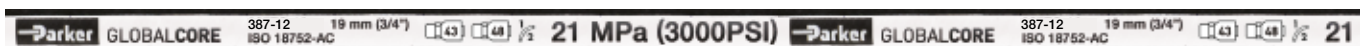

387TC

No-Skive GlobalCore Tough Cover

Sizes -4 to -16 exceed ISO 18752-AC

Sizes -20 to -32 exceed ISO 18752-CC

Primary Applications

General medium pressure hydraulic applications

Applicable Specifications

Exceed ISO 18752-AC and ISO 18752-CC

Construction

Inner tube: Synthetic rubber

Reinforcement: One or two high-tensile steel wire braids (four-spiral for sizes -20 up to -32)

Cover: Highly abrasion resistance
MSHA approved synthetic rubber

Temperature Range -40 °C up to +125 °C

Exception: Air max. +70 °C

Water max. +85 °C







- GlobalCore - *No-Skive*
- ½ ISO 18752 minimum bend radius
- Low force to flex for ease of installation
- 21 MPa constant working pressure
- Highly abrasion resistant **TOUGH COVER**
- MSHA approved
- Hose is suitable for temporary immersion in mineral oil up to 70 °C with frequent inspections

Recommended Fluids

Hydraulic fluids on a mineral-oil basis, water-glycol and lubricating oils, air and water. For air and gas applications with a pressure exceeding 1.7 MPa, the cover must be pin-pricked. Consult the chemical compatibility section on pages **Ab-26** to **Ab-34** for more detailed information.

Fitting Series

Series 43/48 for sizes -4 up to -16  

Series 43/77 for size -20  

Series 77 for sizes -24 up to -32 

Part Number	Hose I.D.				Hose O.D. mm	Pressure Rating				min. bend radius mm	weight kg
	DN	Inch	Size	mm		max. working pressure		min. burst pressure			
						MPa	psi	MPa	psi		
387TC-4	6	1/4	-4	6.4	13.4	21.0	3000	84.0	12000	50	0.24
387TC-6	10	3/8	-6	9.5	17.4	21.0	3000	84.0	12000	65	0.34
387TC-8	12	1/2	-8	12.7	20.7	21.0	3000	84.0	12000	90	0.43
387TC-10	16	5/8	-10	15.9	23.9	21.0	3000	84.0	12000	100	0.49
387TC-12	19	3/4	-12	19.1	27.8	21.0	3000	84.0	12000	120	0.86
387TC-16	25	1	-16	25.4	35.4	21.0	3000	84.0	12000	150	1.17
387TC-20	31	1 1/4	-20	31.8	46.3	21.0	3000	84.0	12000	210	2.59
387TC-24	38	1 1/2	-24	38.1	52.8	21.0	3000	84.0	12000	250	2.99
387TC-32	51	2	-32	50.8	66.2	21.0	3000	84.0	12000	320	4.09

The combination of high temperature and high pressure could reduce the hose life.

Hose layline example

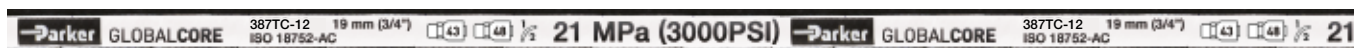

387ST

No-Skive GlobalCore Super Tough

Sizes -4 to -16 exceed ISO 18752-AC

Sizes -20 to -32 exceed ISO 18752-CC

Primary Applications

Medium pressure hydraulic applications with extremely high abrasion risks

Applicable Specifications

Exceed ISO 18752-AC and ISO 18752-CC

Construction

- Inner tube: Synthetic rubber
- Reinforcement: One or two high-tensile steel wire braids (four-spiral for sizes -20 up to -32)
- Cover: Synthetic rubber with a special polyethylene coating

Temperature Range -40 °C up to +125 °C

Exception: Air max. +70 °C

Water max. +85 °C



- GlobalCore - *No-Skive*
 - ½ ISO 18752 minimum bend radius
 - Low force to flex for ease of installation
 - 21 MPa constant working pressure
 - Extreme abrasion resistant
- SUPER TOUGH** cover

Recommended Fluids

Hydraulic fluids on a mineral-oil basis, water-glycol and lubricating oils, air and water. For air and gas applications with a pressure exceeding 1.7 MPa, the cover must be pin-pricked. Consult the chemical compatibility section on pages **Ab-26** to **Ab-34** for more detailed information.

Fitting Series

Series 43/48 for sizes -4 up to -16



Series 43/77 for size -20



Series 77 for sizes -24 up to -32



Part Number	Hose I.D.				Hose O.D. mm	Pressure Rating				min. bend radius mm	weight kg
	DN	Inch	Size	mm		max. working pressure MPa	psi	min. burst pressure MPa	psi		
387ST-4	6	1/4	-4	6.4	13.4	21.0	3000	84.0	12000	50	0.24
387ST-6	10	3/8	-6	9.5	17.4	21.0	3000	84.0	12000	65	0.34
387ST-8	12	1/2	-8	12.7	20.7	21.0	3000	84.0	12000	90	0.43
387ST-10	16	5/8	-10	15.9	23.9	21.0	3000	84.0	12000	100	0.49
387ST-12	19	3/4	-12	19.1	27.8	21.0	3000	84.0	12000	120	0.86
387ST-16	25	1	-16	25.4	35.4	21.0	3000	84.0	12000	150	1.17
387ST-20	31	1 1/4	-20	31.8	46.3	21.0	3000	84.0	12000	210	2.59
387ST-24	38	1 1/2	-24	38.1	52.8	21.0	3000	84.0	12000	250	2.99
387ST-32	51	2	-32	50.8	66.2	21.0	3000	84.0	12000	320	4.09

The combination of high temperature and high pressure could reduce the hose life.

Hose layline example



487

No-Skive GlobalCore

Sizes -4 to -12 exceed ISO 18752-AC
 Sizes -16 to -32 exceed ISO 18752-BC



- GlobalCore - *No-Skive*
- ½ ISO 18752 minimum bend radius
- Low force to flex for ease of installation
- 28 MPa constant working pressure

Primary Applications

General medium pressure hydraulic applications

Applicable Specifications

Exceed ISO 18752-AC and ISO 18752-BC

Construction

- Inner tube: Synthetic rubber
- Reinforcement: One or two high-tensile steel wire braids for sizes -4 up to -12 (four spiral for sizes -16 up to -32)
- Cover: Synthetic rubber

Temperature Range -40 °C up to +100 °C

Exception: Air max. +70 °C

Water max. +85 °C

Recommended Fluids

Hydraulic fluids on a mineral-oil basis, water-glycol and lubricating oils, air and water. For air and gas applications with a pressure exceeding 1.7 MPa, the cover must be pin-pricked. Consult the chemical compatibility section on pages **Ab-26** to **Ab-34** for more detailed information.

Fitting Series

Series 43/48 for sizes -4 up to -12



Series 43 for size -16



Series 77 for sizes -20 up to -32



Part Number	Hose I.D.				Hose O.D. mm	Pressure Rating				min. bend radius mm	weight kg
	DN	Inch	Size	mm		max. working pressure MPa	psi	min. burst pressure MPa	psi		
487-4	6	1/4	-4	6.4	13.1	28.0	4000	112.0	16000	50	0.30
487-6	10	3/8	-6	9.5	17.2	28.0	4000	112.0	16000	65	0.42
487-8	12	1/2	-8	12.7	20.4	28.0	4000	112.0	16000	90	0.52
487-10	16	5/8	-10	15.9	23.9	28.0	4000	112.0	16000	100	0.66
487-12	19	3/4	-12	19.1	27.8	28.0	4000	112.0	16000	120	0.86
487-16	25	1	-16	25.4	37.8	28.0	4000	112.0	16000	150	1.99
487-20	31	1 1/4	-20	31.8	46.3	28.0	4000	112.0	16000	210	2.59
487-24	38	1 1/2	-24	38.1	52.8	28.0	4000	112.0	16000	250	3.08
487-32	51	2	-32	50.8	64.8	28.0	4000	112.0	16000	320	4.09

The combination of high temperature and high pressure could reduce the hose life.

Hose layline example

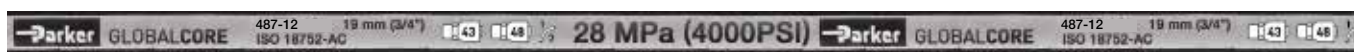

487TC

No-Skive GlobalCore Tough Cover

Sizes -4 to -12 exceed ISO 18752-AC
Sizes -16 to -32 exceed ISO 18752-CC

Primary Applications

General medium pressure hydraulic applications

Applicable Specifications

Exceed ISO 18752-AC and ISO 18752-BC

Construction

Inner tube: Synthetic rubber
Reinforcement: One or two high-tensile steel wire braids for sizes -4 up to -12 (four spiral for sizes -16 up to -32)
Cover: Highly abrasion resistance
MSHA approved synthetic rubber

Temperature Range -40 °C up to +125 °C

Exception: Air max. +70 °C
Water max. +85 °C



- GlobalCore - *No-Skive*
- ½ ISO 18752 minimum bend radius
- Low force to flex for ease of installation
- 28 MPa constant working pressure
- Highly abrasion resistant **TOUGH COVER**
- MSHA approved
- Hose is suitable for temporary immersion in mineral oil up to 70 °C with frequent inspections

Recommended Fluids

Hydraulic fluids on a mineral-oil basis, water-glycol and lubricating oils, air and water. For air and gas applications with a pressure exceeding 1.7 MPa, the cover must be pin-pricked. Consult the chemical compatibility section on pages **Ab-26 to Ab-34** for more detailed information.

Fitting Series

Series 43/48 for sizes -4 up to -12

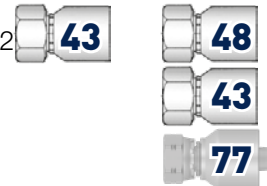

Series 43 for size -16

Series 77 for sizes -20 up to -32

Part Number	Hose I.D.				Hose O.D. mm	Pressure Rating				min. bend radius mm	weight kg
	DN	Inch	Size	mm		max. working pressure MPa	psi	min. burst pressure MPa	psi		
487TC-4	6	1/4	-4	6.4	13.1	28.0	4000	112.0	16000	50	0.30
487TC-6	10	3/8	-6	9.5	17.2	28.0	4000	112.0	16000	65	0.42
487TC-8	12	1/2	-8	12.7	20.4	28.0	4000	112.0	16000	90	0.52
487TC-10	16	5/8	-10	15.9	23.9	28.0	4000	112.0	16000	100	0.66
487TC-12	19	3/4	-12	19.1	27.8	28.0	4000	112.0	16000	120	0.86
487TC-16	25	1	-16	25.4	37.8	28.0	4000	112.0	16000	150	1.99
487TC-20	31	1 1/4	-20	31.8	46.3	28.0	4000	112.0	16000	210	2.59
487TC-24	38	1 1/2	-24	38.1	52.8	28.0	4000	112.0	16000	250	3.08
487TC-32	51	2	-32	50.8	64.8	28.0	4000	112.0	16000	320	4.09

The combination of high temperature and high pressure could reduce the hose life.

Hose layline example

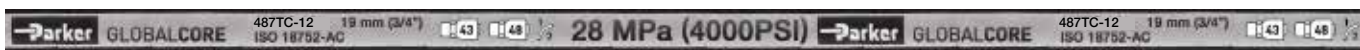

487ST

No-Skive GlobalCore Super Tough

Sizes -4 to -12 exceed ISO 18752-AC

Sizes -16 to -32 exceed ISO 18752-CC

Primary Applications

Medium pressure hydraulic applications with extremely high abrasion risks

Applicable Specifications

Exceed ISO 18752-AC and ISO 18752-BC

Construction

- Inner tube: Synthetic rubber
- Reinforcement: One or two high-tensile steel wire braids for sizes -4 up to -12 (four spiral for sizes -16 up to -32)
- Cover: Synthetic rubber with a special polyethylene coating

Temperature Range -40 °C up to +125 °C

Exception: Air max. +70 °C

Water max. +85 °C



- GlobalCore - *No-Skive*
 - ½ ISO 18752 minimum bend radius
 - Low force to flex for ease of installation
 - 28 MPa constant working pressure
 - Extreme abrasion resistant
- SUPER TOUGH COVER**

Recommended Fluids

Hydraulic fluids on a mineral-oil basis, water-glycol and lubricating oils, air and water. For air and gas applications with a pressure exceeding 1.7 MPa, the cover must be pin-pricked. Consult the chemical compatibility section on pages **Ab-26** to **Ab-34** for more detailed information.

Fitting Series

Series 43/48 for sizes -4 up to -12



Series 43 for size -16



Series 77 for sizes -20 up to -32



Part Number	Hose I.D.				Hose O.D. mm	Pressure Rating				min. bend radius mm	weight kg
	DN	Inch	Size	mm		max. working pressure MPa	psi	min. burst pressure MPa	psi		
487ST-4	6	1/4	-4	6.4	13.1	28.0	4000	112.0	16000	50	0.30
487ST-6	10	3/8	-6	9.5	17.2	28.0	4000	112.0	16000	65	0.42
487ST-8	12	1/2	-8	12.7	20.4	28.0	4000	112.0	16000	90	0.52
487ST-10	16	5/8	-10	15.9	23.9	28.0	4000	112.0	16000	100	0.66
487ST-12	19	3/4	-12	19.1	27.8	28.0	4000	112.0	16000	120	0.86
487ST-16	25	1	-16	25.4	37.8	28.0	4000	112.0	16000	150	1.99
487ST-20	31	1 1/4	-20	31.8	46.3	28.0	4000	112.0	16000	210	2.59
487ST-24	38	1 1/2	-24	38.1	52.8	28.0	4000	112.0	16000	250	3.08
487ST-32	51	2	-32	50.8	64.8	28.0	4000	112.0	16000	320	4.09

The combination of high temperature and high pressure could reduce the hose life.

Hose layline example

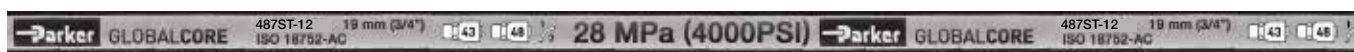

Medium Pressure

Hoses

			Page
Good	BCH1 <i>No-Skive</i>	Standard	Cab-1
Good	BCH2 <i>No-Skive</i>	Standard	Cab-2
	HT2 <i>No-Skive</i>	Low / High temperature	Cab-3
	301SN <i>No-Skive</i>	Standard	Cab-4
	304 <i>No-Skive</i>	Phosphate Ester	Cab-5
Better	412 <i>Elite No-Skive</i>	Pilot	Cab-6
Better	412ST <i>Elite No-Skive</i>	Pilot	Cab-7
	421RH <i>No-Skive</i>	Railway	Cab-8
	421SN <i>No-Skive</i>	Standard	Cab-9
	421TC <i>No-Skive</i>	Standard	Cab-10
	421WC <i>No-Skive</i>	Wire cover	Cab-11
	426 <i>No-Skive</i>	Low / High temperature	Cab-12
	436 <i>No-Skive</i>	Low / High temperature	Cab-13
Better	441 <i>Elite No-Skive</i>	Standard	Cab-14
	441RH <i>No-Skive</i>	Railway	Cab-15
Better	461LT <i>Elite No-Skive</i>	Low / High temperature	Cab-16
Better	462 <i>Elite No-Skive</i>	Standard	Cab-17
	462PU <i>No-Skive</i>	Polyurethane Cover	Cab-18
	462PU Twin <i>No-Skive</i>	Polyurethane Cover	Cab-19
Better	462TC <i>Elite No-Skive</i>	High abrasion resistance	Cab-20
Better	462ST <i>Elite No-Skive</i>	Extreme abrasion resistance	Cab-21
	463 <i>No-Skive</i>	Water cleaning	Cab-22
	471TC <i>No-Skive</i>	High abrasion resistance	Cab-23
Better	477 <i>Elite No-Skive</i>	Powerlift	Cab-24
	477RH <i>No-Skive</i>	Railway	Cab-25
Better	477TC <i>Elite No-Skive</i>	Powerlift	Cab-26
Better	477ST <i>Elite No-Skive</i>	Powerlift	Cab-27
Better	492 <i>Elite No-Skive</i>	Standard	Cab-28
Better	492TC <i>Elite No-Skive</i>	High abrasion resistance	Cab-29
Better	492ST <i>Elite No-Skive</i>	Extreme abrasion resistance	Cab-30
	493 <i>No-Skive</i>	Water cleaning	Cab-31
	692 <i>No-Skive</i>	Extremely flexible	Cab-32
	692Twin <i>No-Skive</i>	Extremely flexible	Cab-33
	692PU <i>No-Skive</i>	Polyurethane Cover	Cab-34
	692PU Twin <i>No-Skive</i>	Polyurethane Cover	Cab-35
	692TC <i>No-Skive</i>	Extremely flexible	Cab-36
	811 <i>No-Skive</i>	Suction	Cab-37
	811S <i>No-Skive</i>	Suction	Cab-38
	881 <i>No-Skive</i>	Suction	Cab-39

Fittings Series	43	46/48	2piece 48	2piece IF
Chapter	Cb	Cc	Cd	Ce
DIN – Metric	1 – 4	1 – 9		
BSP	5 – 8	10 – 18		
SAE	9 – 10	19 – 24	1	
Flange	11 – 13	25 – 29	2	1 – 3
ORFS	14 – 15	30 – 35		
JIS		36 – 37		
High Pressure Cleaning		38 – 39		
Others		40		
UPTC		41 – 42		

Parker Hannifin assumes no liability for typographical errors or other errors

Standard

<p>BCH1 Good</p> <p>Cab-1 </p> <p><i>No-Skive</i> EN 857 1SC – ISO 11237</p>	<p>BCH2 Good</p> <p>Cab-2 </p> <p><i>No-Skive</i> EN 857 2SC – ISO 11237</p>	<p>301SN</p> <p>Cab-4 </p> <p><i>No-Skive</i> EN 853 2SN – ISO 1436 Type 2</p>	<p>421SN</p> <p>Cab-9 </p> <p><i>No-Skive</i> EN 853 1SN – ISO 1436 Type 1</p>
<p>441 Better</p> <p>Cab-14 </p> <p><i>Elite No-Skive</i> ISO 11237 Type R16 – SAE 100R16</p>	<p>462 Better</p> <p>Cab-17 </p> <p><i>Elite No-Skive Compact</i> Exceeds EN 857-2SC – ISO 11237 Type 2SC</p>	<p>492 Better</p> <p>Cab-28 </p> <p><i>Elite No-Skive Compact</i> EN 857 1SC – ISO 11237 Type 1SC</p>	

High abrasion resistance

<p>421TC</p> <p>Cab-10 </p> <p><i>No-Skive</i> EN 853 1SN – ISO 1436 Type 1</p>	<p>462TC Better</p> <p>Cab-20 </p> <p><i>Elite No-Skive Compact Tough Cover</i> Exceeds EN 857-2SC – ISO 11237 Type 2SC</p>	<p>471TC</p> <p>Cab-23 </p> <p><i>No-Skive</i> EN 857 2SC – ISO 11237 Type 2SC</p>	<p>492TC Better</p> <p>Cab-29 </p> <p><i>Elite No-Skive Compact Tough Cover</i> EN 857 1SC – ISO 11237 Type 1SC</p>
---	--	---	--

Extreme abrasion resistance

<p>462ST Better</p> <p>Cab-21 </p> <p><i>Elite No-Skive Super Tough Compact</i> EN 857 2SC – ISO 11237 Type 2SC</p>	<p>492ST Better</p> <p>Cab-30 </p> <p><i>Elite No-Skive Super Tough Compact</i> EN 857 1SC – ISO 11237 Type 1SC</p>
--	--

Low / High temperature

<p>HT2</p> <p>Cab-3 </p> <p><i>No-Skive Compact</i> Parker specification</p>	<p>426</p> <p>Cab-12 </p> <p><i>No-Skive</i> SAE 100R1AT high temperature</p>	<p>436</p> <p>Cab-13 </p> <p><i>No-Skive Compact</i> SAE 100R16 high temperature</p>	<p>461LT Better</p> <p>Cab-16 </p> <p><i>Elite No-Skive Compact</i> EN 857 2SC low temperature</p>
--	---	---	---

Phosphate Ester

304

Cab-5 

No-Skive
Phosphate ester resistant hose

Railway

<p>421RH Cab-8</p>  <p><i>No-Skive</i> Fire-retardant cover</p>	<p>441RH Cab-15</p>  <p><i>No-Skive Compact</i> Fire-retardant cover</p>	<p>477RH Cab-25</p>  <p><i>Elite No-Skive PowerLift</i> 2 wire braided with fire-retardant cover</p>
---	--	---

Water cleaning

<p>463 Cab-22</p>  <p><i>No-Skive Compact</i> High pressure water cleaning applications</p>	<p>493 Cab-31</p>  <p><i>No-Skive Compact</i> High pressure water cleaning applications</p>
---	---

Pilot

<p>412 Better Cab-6</p>  <p><i>Elite No-Skive RemoFlex</i> 1 wire braided hose for pilot lines</p>	<p>412ST Better Cab-7</p>  <p><i>Elite No-Skive RemoFlex</i> 1 wire braided hose for pilot lines</p>
---	---

Wire cover

421WC
Cab-11



No-Skive
Galvanised steel wire cover

Powerlift

<p>477 Better Cab-24</p>  <p><i>Elite No-Skive PowerLift</i> 2 wire braided</p>	<p>477TC Better Cab-26</p>  <p><i>Elite No-Skive PowerLift Tough Cover</i> 2 wire braided</p>	<p>477ST Better Cab-27</p>  <p><i>Elite No-Skive PowerLift</i> 2 wire braided</p>
--	--	---

Extremely flexible

<p>692 Cab-32</p>  <p><i>No-Skive Compact</i> Constant pressure, tight bend radius</p>	<p>692Twin Cab-33</p>  <p><i>No-Skive Compact</i> Twin constant pressure, tight bend radius</p>	<p>692TC Cab-36</p>  <p><i>No-Skive Compact Tough Cover</i> Constant pressure, tight bend radius</p>
--	---	---

Polyurethane Cover

462PU

Cab-18



No-Skive Compact
Polyurethane Cover

462PU Twin

Cab-19



No-Skive Compact
Twin Hose with Polyurethane Cover

692PU

Cab-34



No-Skive Compact
Polyurethane Cover

692PU Twin

Cab-35



No-Skive Compact
Twin Hose with Polyurethane Cover

Suction

811

Cab-37



No-Skive Suction and Return Line
SAE 100R4

811S

Cab-38



No-Skive Suction and Return Line
Exceeds SAE 100R4

881

Cab-39



No-Skive Suction and Return Line
SAE 100R4

BCH1

No-Skive

EN 857 1SC – ISO 11237



- *No-Skive* hose construction
- High performance
- NBR inner tube – extended fluid compatibility
- Meets specified working pressure and bend radius of EN 857 1SC
- Synthetic rubber cover compound
- Tight bending radius

Primary Applications

Demanding medium pressure hydraulic applications in all markets

Construction

Inner tube: Nitrile (NBR)
Reinforcement: One high-tensile steel wire braid
Cover: Synthetic rubber

Temperature Range -40 °C up to +100 °C

Exception: Air max. +70 °C
Water max. +85 °C

Recommended Fluids

Hydraulic fluids on a mineral-oil basis, water-glycol and lubricating oils, air and water. For air and gas applications with a pressure exceeding 1.7 MPa, the cover must be pin-pricked.

Consult the chemical compatibility section on pages **Ab-26** to **Ab-34** for more detailed information.

Fitting Series



Part Number	Hose I.D.				Hose O.D. mm	Pressure Rating				min. bend radius mm	weight kg
	DN	Inch	Size	mm		max. working pressure MPa	psi	min. burst pressure MPa	psi		
BCH1-4	6	1/4	-4	6.4	11.5	22.5	3260	90.0	13050	75	0.17
BCH1-5	8	5/16	-5	7.9	13.6	21.5	3110	86.0	12470	85	0.20
BCH1-6	10	3/8	-6	9.5	15.5	18.0	2610	72.0	10440	90	0.24
BCH1-8	12	1/2	-8	12.7	18.9	16.0	2320	64.0	9280	130	0.33
BCH1-10	16	5/8	-10	15.9	22.2	13.0	1885	52.0	7540	150	0.41
BCH1-12	20	3/4	-12	19.1	26.0	10.5	1520	42.0	6080	180	0.56
BCH1-16	25	1	-16	25.4	33.3	8.8	1275	35.2	5100	230	0.75

The combination of high temperature and high pressure could reduce the hose life.

Hose layline example

Parker NO-SKIVE BCH1-6 WP 18.0 MPa (2610 PSI) | •• 10 mm (3/8) EN857/1SC/10 MADE IN ITALY

BCH2

No-Skive

EN 857 2SC – ISO 11237



- *No-Skive* hose construction
- High performance
- NBR inner tube – extended fluid compatibility
- Meets specified working pressure and bend radius of EN 857 2SC
- Synthetic rubber cover compound
- Tight bending radius

Primary Applications

Demanding medium pressure hydraulic applications in all markets

Construction

Inner tube: Nitrile (NBR)
Reinforcement: Two high-tensile steel wire braids
Cover: Synthetic rubber

Temperature Range -40 °C up to +100 °C

Exception: Air max. +70 °C
Water max. +85 °C

Recommended Fluids

Hydraulic fluids on a mineral-oil basis, water-glycol and lubricating oils, air and water. For air and gas applications with a pressure exceeding 1.7 MPa, the cover must be pin-pricked.

Consult the chemical compatibility section on pages **Ab-26** to **Ab-34** for more detailed information.

Fitting Series



Part Number	Hose I.D.				Hose O.D. mm	Pressure Rating				min. bend radius mm	weight kg
	DN	Inch	Size	mm		max. working pressure		min. burst pressure			
						MPa	psi	MPa	psi		
BCH2-4	6	1/4	-4	6.4	13.4	40.0	5800	160.0	23200	75	0.28
BCH2-5	8	5/16	-5	7.9	15.0	35.0	5000	140.0	20000	85	0.31
BCH2-6	10	3/8	-6	9.5	17.2	33.0	4800	132.0	19200	90	0.39
BCH2-8	12	1/2	-8	12.7	20.4	27.5	4000	110.0	16000	130	0.50
BCH2-10	16	5/8	-10	15.9	23.9	25.0	3600	100.0	14400	170	0.63
BCH2-12	20	3/4	-12	19.1	27.7	21.5	3100	86.0	12400	200	0.81
BCH2-16	25	1	-16	25.4	35.4	16.5	2400	66.0	9600	250	1.06

The combination of high temperature and high pressure could reduce the hose life.

Hose layline example

 NO-SKIVE BCH2-6 WP 33 MPa (4800 PSI) 1 •• 10 mm (3/8) EN857/2SC/10 MADE IN ITALY

HT2

No-Skive Compact

Parker specification

Primary Applications

Many industrial and mobile applications, with typical usage seen on agricultural machines or in power steering circuits

Applicable Specifications

Parker Specification

Construction

Inner tube: Nitrile (NBR)
Reinforcement: Two high-tensile steel wire braids
Cover: Synthetic rubber

Temperature Range -40 °C up to +125 °C
with peaks up to +135 °C

Exception: Air max. +70 °C
Water max. +85 °C



- **No-Skive** hose construction
– Compact design
- +125 °C working temperature with peaks up to +135 °C

Recommended Fluids

Hydraulic fluids on a mineral-oil basis, water-glycol and lubricating oils, air and water. For air and gas applications with a pressure exceeding 1.7 MPa, the cover must be pin-pricked. Consult the chemical compatibility section on pages **Ab-26** to **Ab-34** for more detailed information.

Fitting Series



Part Number	Hose I.D.				Hose O.D. mm	Pressure Rating				min. bend radius mm	weight kg
	DN	Inch	Size	mm		max. working pressure MPa	psi	min. burst pressure MPa	psi		
HT2-4	6	1/4	4	6.4	13.4	35.0	5000	140.0	20000	50	0.30
HT2-5	8	5/16	5	7.9	15.0	29.7	4250	118.8	17000	55	0.35
HT2-6	10	3/8	6	9.5	17.2	28.0	4000	112.0	16000	65	0.42
HT2-8	12	1/2	8	12.7	20.4	24.5	3500	98.0	14000	90	0.52
HT2-10	16	5/8	10	15.9	23.9	19.2	2750	76.8	11000	100	0.66
HT2-12	19	3/4	12	19.1	27.7	15.7	2250	62.8	9000	120	0.86
HT2-16	25	1	16	25.4	35.4	14.0	2000	56.0	8000	150	1.17

The combination of high temperature and high pressure could reduce the hose life.

Hose layline example



301SN

No-Skive

EN 853 2SN – ISO 1436 Type 2



- *No-Skive* thin cover hose construction
- Nitrile (NBR) inner tube
– extended fluid compatibility

Primary Applications

General medium pressure hydraulic applications

Type Approvals

Details please find on pages **Ab-16** to **Ab-19**

Applicable Specifications

EN 853 2SN – ISO 1436 Type 2 – SAE 100R2AT

Construction

Inner tube: Nitrile (NBR)
Reinforcement: Two high-tensile steel wire braids
Cover: Synthetic rubber

Temperature Range -40 °C up to +100 °C

Exception: Air max. +70 °C
Water max. +85 °C

Recommended Fluids

Hydraulic fluids on a mineral-oil basis, water-glycol and lubricating oils, air and water. For air and gas applications with a pressure exceeding 1.7 MPa, the cover must be pin-pricked.

Consult the chemical compatibility section on pages **Ab-26** to **Ab-34** for more detailed information.

Fitting Series



Part Number	Hose I.D.				Hose O.D. mm	Pressure Rating				min. bend radius mm	weight kg
	DN	Inch	Size	mm		max. working pressure MPa	psi	min. burst pressure MPa	psi		
301SN-4	6	1/4	-4	6.4	15.0	40.0	5800	160.0	23200	100	0.39
301SN-5	8	5/16	-5	7.9	16.6	35.0	5075	140.0	20300	115	0.42
301SN-6	10	3/8	-6	9.5	19.0	33.0	4775	132.0	19100	130	0.55
301SN-8	12	1/2	-8	12.7	22.2	27.5	4000	110.0	16000	180	0.67
301SN-10	16	5/8	-10	15.9	25.4	25.0	3600	100.0	14500	200	0.77
301SN-12	19	3/4	-12	19.1	29.3	21.5	3100	86.0	12400	240	1.00
301SN-16	25	1	-16	25.4	38.1	16.5	2400	66.0	9600	300	1.49
301SN-20	31	1 1/4	-20	31.8	47.5	12.5	1800	50.0	7200	420	1.73
301SN-24	38	1 1/2	-24	38.1	55.0	9.0	1300	36.0	5200	500	2.14
301SN-32	51	2	-32	50.8	67.0	8.0	1150	32.0	4600	630	2.96

The combination of high temperature and high pressure could reduce the hose life.

Hose layline example

PARKER NO-SKIVE 301SN-4 WP 40,0 MPa (400 BAR) l · · SAE100R2AT-4 6,3MM (1/4") X 2W EN853/2SN/6/DIN

304

No-Skive

Phosphate ester resistant hose

Primary Applications

Aerospace, foundries, steel mills:
Medium pressure hydraulic applications with phosphate ester fluids

Applicable Specifications

Parker Specification

Restrictions

Do not allow tube to contact any petroleum base fluids.
Use liquid soap as hose lubricant.

Construction

Inner tube: EPDM synthetic rubber
Reinforcement: Two high-tensile steel wire braids
Cover: EPDM synthetic rubber green, phosphate ester and weather resistant

Temperature Range -40 °C up to +80 °C

Exception: Air max. +70 °C
Water, water glycol fluids .. max. +85 °C



- **No-Skive** thin cover hose construction
- Phosphate ester and weather resistant, green, EPDM synthetic rubber cover
- SAE 100R2 pressure rating

Recommended Fluids

Phosphate ester based hydraulic fluids, water-glycol based fluids, air and water.
Consult the chemical compatibility section on pages **Ab-26** to **Ab-34** for more detailed information.

Fitting Series

Series 43 for sizes -4 up to -32
Series 48 for sizes -20 up to -32



Part Number	Hose I.D.				Hose O.D. mm	Pressure Rating				min. bend radius mm	weight kg
	DN	Inch	Size	mm		max. working pressure MPa	psi	min. burst pressure MPa	psi		
304-4	6	1/4	-4	6.4	15.0	34.5	5000	138.0	20000	100	0.39
304-6	10	3/8	-6	9.5	19.0	27.5	4000	110.0	16000	130	0.55
304-8	12	1/2	-8	12.7	22.0	24.0	3500	96.0	14000	180	0.67
304-12	19	3/4	-12	19.1	30.0	15.5	2250	62.0	9000	240	1.00
304-16	25	1	-16	25.4	38.0	13.8	2000	55.0	8000	300	1.49
304-20	31	1 1/4	-20	31.8	48.0	11.2	1625	45.0	6500	420	1.73
304-24	38	1 1/2	-24	38.1	55.0	8.6	1250	35.0	5075	500	2.14
304-32	51	2	-32	50.8	68.0	7.8	1125	31.0	4500	630	2.96

The combination of high temperature and high pressure could reduce the hose life.

Hose layline example

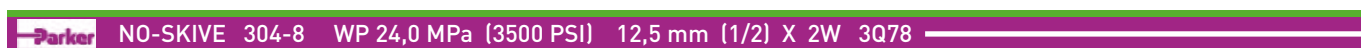

412

Elite No-Skive RemoFlex

1 wire braided hose for pilot lines

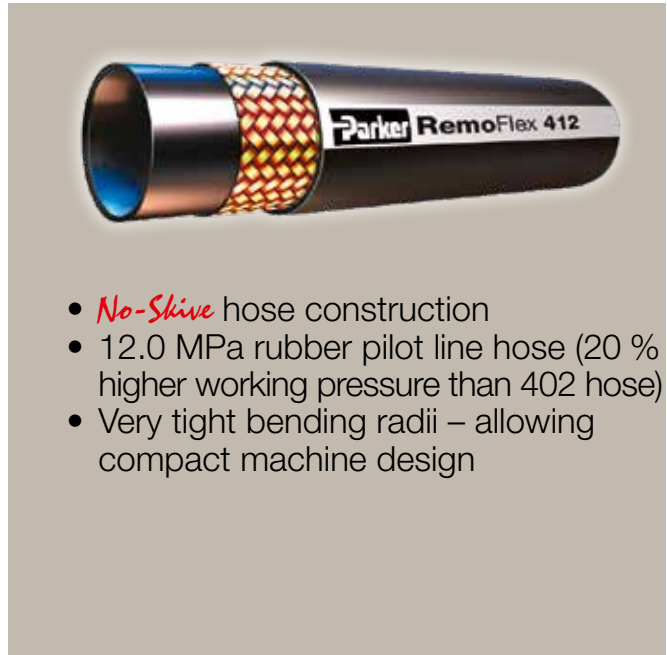

- *No-Skive* hose construction
- 12.0 MPa rubber pilot line hose (20 % higher working pressure than 402 hose)
- Very tight bending radii – allowing compact machine design

Primary Applications

Mobile hydraulic equipment: Pilot lines

Construction

Inner tube: Nitrile (NBR)
 Reinforcement: One high-tensile steel wire braid
 Cover: Synthetic rubber

Temperature Range -40 °C up to +100 °C

Exception: Air max. +70 °C
 Water max. +85 °C

Recommended Fluids

Hydraulic fluids on a mineral-oil basis, water-glycol and lubricating oils, air and water. For air and gas applications with a pressure exceeding 1.7 MPa, the cover must be pin-pricked.

Consult the chemical compatibility section on pages **Ab-26** to **Ab-34** for more detailed information.

Fitting Series

- Available as complete hose assembly
- Compatible with 2-piece fittings for use with adjustable crimpers only (47 series nipple and 10049 series shell)

Part Number	Hose I.D.				Hose O.D. mm	Pressure Rating				min. bend radius mm	weight kg
	DN	Inch	Size	mm		max. working pressure		min. burst pressure			
						MPa	psi	MPa	psi		
412-3	5	3/16	-3	4.8	9.1	12.0	1700	48.0	6800	20	0.08
412-4	6	1/4	-4	6.4	11.0	12.0	1700	48.0	6800	25	0.14
412-5	8	5/16	-5	7.9	13.0	12.0	1700	48.0	6800	30	0.18
412-6	10	3/8	-6	9.5	14.0	12.0	1700	48.0	6800	40	0.23

The combination of high temperature and high pressure could reduce the hose life.

Hose layline example



412ST

Elite No-Skive RemoFlex

1 wire braided hose for pilot lines



- *No-Skive* hose construction
- 12.0 MPa rubber pilot line hose
- Very tight bending radii – allowing compact machine design
- Extreme abrasion resistant
SUPER TOUGH cover

Primary Applications

Mobile hydraulic equipment: Pilot lines

Construction

Inner tube: Nitrile (NBR)
Reinforcement: One high-tensile steel wire braid
Cover: Synthetic rubber
with a special polyethylene coating

Temperature Range -40 °C up to +100 °C

Exception: Air max. +70 °C
Water max. +85 °C

Recommended Fluids

Hydraulic fluids on a mineral-oil basis, water-glycol and lubricating oils, air and water. For air and gas applications with a pressure exceeding 1.7 MPa, the cover must be pin-pricked.

Consult the chemical compatibility section on pages **Ab-26** to **Ab-34** for more detailed information.

Fitting Series

- Available as complete hose assembly
- Compatible with 2-piece fittings for use with adjustable crimpers only (47 series nipple and 10049 series shell)

Part Number	Hose I.D.				Hose O.D. mm	Pressure Rating				min. bend radius mm	weight kg
	DN	Inch	Size	mm		max. working pressure		min. burst pressure			
						MPa	psi	MPa	psi		
412ST-3	5	3/16	-3	4.8	9.6	12.0	1700	48.0	6800	20	0.08
412ST-4	6	1/4	-4	6.4	11.6	12.0	1700	48.0	6800	25	0.14
412ST-5	8	5/16	-5	7.9	13.0	12.0	1700	48.0	6800	30	0.18
412ST-6	10	3/8	-6	9.5	14.0	12.0	1700	48.0	6800	40	0.23

The combination of high temperature and high pressure could reduce the hose life.

Hose layline example

Parker Elite **SUPER TOUGH** 412ST-6 RemoFlex WP 12,0 MPa (1700 PSI) | • • 9,5 mm (3/8") Made in Italy

421RH

No-Skive

Fire-retardant cover

Primary Applications

General medium-pressure hydraulic and pneumatic systems as well as water and oil cooling circuits

Type Approvals

Details please find on pages **Ab-16** to **Ab-19**

Applicable Specifications

EN 853 1SN – ISO 1436 Typ 1 – SAE 100R1AT

Construction

Inner tube: Nitrile (NBR)
Reinforcement: One high-tensile steel wire braid
Cover: Fire retardant synthetic rubber

Temperature Range -40 °C up to +100 °C

Exception: Air max. +70 °C

Water max. +85 °C



- *No-Skive* thin cover hose construction
- Nitrile (NBR) inner tube
– extended fluid compatibility
- Suitable with 48 series fittings
- Fire-retardant cover
- Railway approved:
 - European Standard EN45545 HL2 for R22 (internal) and R23 (external)
 - ISO 15540

Recommended Fluids

Hydraulic fluids on a mineral-oil basis, water-glycol and lubricating oils, air and water. For air and gas applications with a pressure exceeding 1.7 MPa, the cover must be pin-pricked. Consult the chemical compatibility section on pages **Ab-26** to **Ab-34** for more detailed information.

Fitting Series



Part Number	Hose I.D.				Hose O.D. mm	Pressure Rating				min. bend radius mm	weight kg
	DN	Inch	Size	mm		max. working pressure MPa	psi	min. burst pressure MPa	psi		
421RH-20	31	1 1/4	-20	31.8	44.8	6.3	900	25.0	3600	420	1.19
421RH-24	38	1 1/2	-24	38.1	51.1	5.0	725	20.0	2900	500	1.49
421RH-32	51	2	-32	50.8	64.7	4.0	575	16.0	2300	630	2.23

The combination of high temperature and high pressure could reduce the hose life.

Hose layline example

Parker RAIL HOSE 421RH-24 WP 5,0 MPa (725 PSI) 1" - EN 45545 - 38 mm (1 1/2") - ISO 1436-1 - MADE IN I

421SN

No-Skive

EN 853 1SN – ISO 1436 Type 1



- *No-Skive* thin cover hose construction
- Nitrile (NBR) inner tube
– extended fluid compatibility

Primary Applications

General medium pressure hydraulic applications

Type Approvals

Details please find on pages **Ab-16** to **Ab-19**

Applicable Specifications

EN 853 1SN – ISO 1436 Type 1 – SAE 100R1AT

Construction

Inner tube: Nitrile (NBR)
Reinforcement: One high-tensile steel wire braid
Cover: Synthetic rubber

Temperature Range -40 °C up to +100 °C

Exception: Air max. +70 °C
Water max. +85 °C

Recommended Fluids

Hydraulic fluids on a mineral-oil basis, water-glycol and lubricating oils, air and water. For air and gas applications with a pressure exceeding 1.7 MPa, the cover must be pin-pricked.

Consult the chemical compatibility section on pages **Ab-26** to **Ab-34** for more detailed information.

Fitting Series



Part Number	Hose I.D.				Hose O.D. mm	Pressure Rating				min. bend radius mm	weight kg
	DN	Inch	Size	mm		max. working pressure		min. burst pressure			
						MPa	psi	MPa	psi		
421SN-4	6	1/4	-4	6.4	13.4	22.5	3250	90.0	13000	100	0.24
421SN-5	8	5/16	-5	7.9	15.0	21.5	3125	86.0	12500	115	0.27
421SN-6	10	3/8	-6	9.5	17.4	18.0	2600	72.0	10400	130	0.34
421SN-8	12	1/2	-8	12.7	20.7	16.0	2325	64.0	9300	180	0.43
421SN-10	16	5/8	-10	15.9	23.9	13.0	1875	52.0	7500	200	0.49
421SN-12	19	3/4	-12	19.1	27.8	10.5	1525	42.0	6100	240	0.63
421SN-16	25	1	-16	25.4	35.8	8.8	1275	35.0	5075	300	0.94
421SN-20	31	1 1/4	-20	31.8	44.8	6.3	900	25.2	3600	420	1.19
421SN-24	38	1 1/2	-24	38.1	51.1	5.0	725	20.0	2900	500	1.49
421SN-32	51	2	-32	50.8	64.7	4.0	575	16.0	2300	630	2.23

The combination of high temperature and high pressure could reduce the hose life.

Hose layline example

PARKER NO-SKIVE 421SN-8 WP 16,0 MPa (160 BAR) l * * SAE 100R1AT-8 12,5 MM (1/2) X1W EN 853/1SN/12/DIN

421TC

No-Skive

EN 853 1SN – ISO 1436 Type 1



- *No-Skive* thin cover hose construction
- Nitrile (NBR) inner tube
– extended fluid compatibility
- Highly abrasion resistant **TOUGH COVER**
- MSHA approved
- Hose is suitable for temporary immersion in mineral oil up to 70 °C with frequent inspections

Primary Applications

Demanding medium pressure hydraulic applications

Type Approvals

Details please find on pages **Ab-16** to **Ab-19**

Applicable Specifications

EN 853 1SN – ISO 1436 Type 1 – SAE 100R1AT

Construction

Inner Tube: Nitrile (NBR)
Reinforcement: One high-tensile steel wire braid
Cover: MSHA approved synthetic rubber

Temperature Range -40 °C up to +100 °C

Exception: Air max. +70 °C
Water max. +85 °C

Recommended Fluids

Hydraulic fluids on a mineral-oil basis, water-glycol and lubricating oils, air and water. For air and gas applications with a pressure exceeding 1.7 MPa, the cover must be pin-pricked.

Consult the chemical compatibility section on pages **Ab-26** to **Ab-34** for more detailed information.

Fitting Series



Part Number	Hose I.D.				Hose O.D. mm	Pressure Rating				min. bend radius mm	weight kg
	DN	Inch	Size	mm		max. working pressure		min. burst pressure			
						MPa	psi	MPa	psi		
421TC-4	6	1/4	-4	6.4	13.4	22.5	3250	90.0	13000	100	0.24
421TC-5	8	5/16	-5	7.9	15.0	21.5	3125	86.0	12500	115	0.27
421RTC-6	10	3/8	-6	9.5	17.4	18.0	2600	72.0	10400	130	0.34
421TC-8	12	1/2	-8	12.7	20.7	16.0	2325	64.0	9300	180	0.43
421TC-10	16	5/8	-10	15.9	23.9	13.0	1875	52.0	7500	200	0.49
421TC-12	19	3/4	-12	19.1	27.8	10.5	1525	42.0	6100	240	0.63
421TC-16	25	1	-16	25.4	35.8	8.8	1275	35.0	5075	300	0.94
421TC-20	31	1 1/4	-20	31.8	44.8	6.3	900	25.2	3600	420	1.19
421TC-24	38	1 1/2	-24	38.1	51.1	5.0	725	20.0	2900	500	1.49
421TC-32	51	2	-32	50.8	64.7	4.0	575	16.0	2300	630	2.23

The combination of high temperature and high pressure could reduce the hose life.

Hose layline example



421WC

No-Skive

Galvanised steel wire cover



- *No-Skive* thin cover hose construction
- Metal and glass hot-spot resistance

Primary Applications

Machine tool and glass industry

Applicable Specifications

SAE 100 R1AT

Construction

- Inner tube: Synthetic rubber
- Reinforcement: One high-tensile steel wire braid
- Cover: Galvanized steel wire

Temperature Range -40 °C up to +125 °C

- Exception: Air max. +70 °C
- Water max. +85 °C

Recommended Fluids

Hydraulic fluids on a mineral-oil basis, water-glycol and lubricating oils, air and water.

Consult the chemical compatibility section on pages **Ab-26** to **Ab-34** for more detailed information.

Fitting Series



Part Number	Hose I.D.				Hose O.D. mm	Pressure Rating				min. bend radius mm	weight kg
	DN	Inch	Size	mm		max. working pressure		min. burst pressure			
						MPa	psi	MPa	psi		
421WC-4	6	1/4	-4	6.4	15.0	19.0	2750	76.0	11000	100	0.38
421WC-6	10	3/8	-6	9.5	19.0	15.5	2250	62.0	9000	130	0.54
421WC-8	12	1/2	-8	12.7	22.0	13.8	2000	55.0	8000	180	0.67
421WC-12	19	3/4	-12	19.1	29.0	8.6	1250	35.0	5075	240	0.95
421WC-16	25	1	-16	25.4	37.0	6.9	1000	28.0	4000	300	1.31

The combination of high temperature and high pressure could reduce the hose life.

426

No-Skive

SAE 100R1AT high temperature

Primary Applications

Medium pressure hydraulic applications at high temperature

Type Approvals

Details please find on pages **Ab-16** to **Ab-19**

Applicable Specifications

SAE 100 R1AT

Construction

Inner tube: PKR synthetic rubber
Reinforcement: One high-tensile steel wire braid
Cover: Synthetic rubber , blue

Temperature Range -46 °C up to +150 °C

Exception: Air max. +70 °C
Water, water glycol fluids .. max. +85 °C



- **No-Skive** thin cover hose construction
- SAE 100R1 pressure rating
- Ideal for high temperature applications

Recommended Fluids

Hydraulic fluids on a mineral-oil basis, water-glycol and lubricating oils, air and water.

Consult the chemical compatibility section on pages **Ab-26** to **Ab-34** for more detailed information.

Fitting Series

Series 43 for sizes -4 up to -6
Series 48 for sizes -8 up to -32



Part Number	Hose I.D.				Hose O.D. mm	Pressure Rating				min. bend radius mm	weight kg
	DN	Inch	Size	mm		max. working pressure		min. burst pressure			
						MPa	psi	MPa	psi		
426-4-RL	6	1/4	-4	6.4	13.4	19.2	2750	77.0	11000	100	0.24
426-6-RL	10	3/8	-6	9.5	17.4	15.7	2250	63.0	9000	125	0.34
426-8-RL	12	1/2	-8	12.7	20.7	14.0	2000	56.0	8000	180	0.43
426-10-RL	16	5/8	-10	15.9	23.9	10.5	1500	42.0	6000	200	0.49
426-12-RL	19	3/4	-12	19.1	27.8	8.7	1250	35.0	5075	240	0.65
426-16-RL	25	1	-16	25.4	35.8	7.0	1000	28.0	4000	300	0.98
426-20	31	1 1/4	-20	31.8	45.0	4.3	625	17.2	2500	420	1.40
426-24	38	1 1/2	-24	38.1	51.0	3.5	500	14.0	2000	500	1.46
426-32	51	2	-32	50.8	64.0	2.6	375	10.4	1500	630	2.18

The combination of high temperature and high pressure could reduce the hose life.
RL = only available on reels.

Hose layline example



436

No-Skive Compact

SAE 100R16 high temperature

Primary Applications

Medium pressure hydraulic applications at high temperature

Type Approvals

Details please find on pages **Ab-16** to **Ab-19**

Applicable Specifications

SAE 100R16

Construction

Inner tube: PKR synthetic rubber
Reinforcement: Two high-tensile steel wire braids
Cover: MSHA approved blue

Temperature Range -48 °C up to +150 °C

Exception: Air max. +70 °C
Water, water glycol fluids .. max. +85 °C



- **No-Skive** thin cover hose construction
- Compact hose construction with tight bend radius
- MSHA approved
- Ideal for high temperature applications

Recommended Fluids

Hydraulic fluids on a mineral-oil basis, water-glycol and lubricating oils, air and water.

Consult the chemical compatibility section on pages **Ab-26** to **Ab-34** for more detailed information.

Fitting Series



Part Number	Hose I.D.				Hose O.D. mm	Pressure Rating				min. bend radius mm	weight kg
	DN	Inch	Size	mm		max. working pressure MPa	psi	min. burst pressure MPa	psi		
436-6-BLU-RL	10	3/8	-6	9.5	17.0	27.5	4000	110.0	16000	65	0.42
436-8-BLU-RL	12	1/2	-8	12.7	20.0	24.0	3500	96.0	14000	90	0.51
436-10-BLU-RL	16	5/8	-10	15.9	24.0	19.0	2750	76.0	11000	100	0.66
436-12-BLU-RL	19	3/4	-12	19.1	28.0	15.5	2250	62.0	9000	120	0.80
436-16-BLU-RL	25	1	-16	25.4	36.0	13.8	2000	55.0	8000	150	1.22

The combination of high temperature and high pressure could reduce the hose life.
RL = only available on reels.

Hose layline example



441

Elite No-Skive

ISO 11237 Type R16 – SAE 100R16



- *No-Skive* hose construction
- One wire braid construction – two wire braid performance
- +125 °C working temperature

Primary Applications

Many industrial and mobile applications, with typical usage seen on agricultural machines or in power steering circuits

Applicable Specifications

ISO 11237 Type R16 – SAE 100R16

Construction

Inner tube: Synthetic rubber
Reinforcement: One high-tensile steel wire braid
Cover: Synthetic rubber

Temperature Range -40 °C up to +125 °C

Exception: Air max. +70 °C
Water max. +85 °C

Recommended Fluids

Hydraulic fluids on a mineral-oil basis, water-glycol and lubricating oils, air and water. For air and gas applications with a pressure exceeding 1.7 MPa, the cover must be pin-pricked.

Consult the chemical compatibility section on pages **Ab-26** to **Ab-34** for more detailed information.

Fitting Series



Part Number	Hose I.D.				Hose O.D. mm	Pressure Rating				min. bend radius mm	weight kg
	DN	Inch	Size	mm		max. working pressure MPa	psi	min. burst pressure MPa	psi		
441-4	6	1/4	-4	6.4	13.4	35.0	5000	140.0	20000	50	0.27
441-5	8	5/16	-5	7.9	15.0	29.7	4250	118.8	17000	55	0.32
441-6	10	3/8	-6	9.5	17.4	28.0	4000	112.0	16000	65	0.42
441-8	12	1/2	-8	12.7	20.7	24.5	3500	98.0	14000	90	0.50
441-10	16	5/8	-10	15.9	23.8	19.2	2750	76.8	11000	100	0.65
441-12	19	3/4	-12	19.1	27.8	15.7	2250	62.8	9000	120	0.80
441-16	25	1	-16	25.4	35.8	14.0	2000	56.0	8000	150	1.22

The combination of high temperature and high pressure could reduce the hose life.
Also available on reels up to size -12 under part number 441-xx-RL

Hose layline example



441RH

No-Skive Compact

Fire-retardant cover

Primary Applications

General medium-pressure hydraulic and pneumatic systems as well as water and oil cooling circuits

Type Approvals

Details please find on pages **Ab-16** to **Ab-19**

Applicable Specifications

Parker Specification; Working pressure to SAE 100R2;
Bend radius to SAE 100R16

Construction

Inner tube: Synthetic rubber
Reinforcement: One high-tensile steel wire braid
Cover: Fire retardant synthetic rubber

Temperature Range -40 °C up to +125 °C

Exception: Air max. +70 °C
Water max. +85 °C



- **No-Skive** hose construction
- One wire braid construction – two wire braid performance
- +125 °C working temperature
- Fire-retardant cover
- Railway approved:
 - European Standard EN45545 HL2 for R22 (internal) and HL3 for R23 (external)
 - ISO 15540

Recommended Fluids

Hydraulic fluids on a mineral-oil basis, water-glycol and lubricating oils, air and water. For air and gas applications with a pressure exceeding 1.7 MPa, the cover must be pin-pricked. Consult the chemical compatibility section on pages **Ab-26** to **Ab-34** for more detailed information.

Fitting Series



Part Number	Hose I.D.				Hose O.D. mm	Pressure Rating				min. bend radius mm	weight kg
	DN	Inch	Size	mm		max. working pressure MPa	psi	min. burst pressure MPa	psi		
441RH-4	6	1/4	-4	6.4	13.4	35.0	5000	140.0	20000	50	0.27
441RH-5	8	5/16	-5	7.9	15.0	29.7	4250	118.8	17000	55	0.32
441RH-6	10	3/8	-6	9.5	17.4	28.0	4000	112.0	16000	65	0.42
441RH-8	12	1/2	-8	12.7	20.7	24.5	3500	98.0	14000	90	0.50
441RH-10	16	5/8	-10	15.9	23.8	19.2	2750	76.8	11000	100	0.65
441RH-12	19	3/4	-12	19.1	27.8	15.7	2250	62.8	9000	120	0.80
441RH-16	25	1	-16	25.4	35.8	14.0	2000	56.0	8000	150	1.22

The combination of high temperature and high pressure could reduce the hose life.

Hose layline example



461LT

Elite No-Skive Compact

EN 857 2SC low temperature



- *No-Skive* thin cover hose construction
- Excellent ozone resistance
- Ideal for low temperature working conditions (-50 °C)

Primary Applications

Mobile applications in low temperature environments:
Forestry machines, refrigerated warehouses

Applicable Specifications

EN 857 2SC

Construction

Inner tube: Synthetic rubber
Reinforcement: Two high-tensile steel wire braids
Cover: Synthetic rubber

Temperature Range -50 °C up to +100 °C

Exception: Air max. +70 °C
Water max. +85 °C

Recommended Fluids

Hydraulic fluids on a mineral-oil basis, water-glycol and lubricating oils, air and water. For air and gas applications with a pressure exceeding 1.7 MPa, the cover must be pin-pricked.

Consult the chemical compatibility section on pages **Ab-26** to **Ab-34** for more detailed information.

Fitting Series



Part Number	Hose I.D.				Hose O.D. mm	Pressure Rating				min. bend radius mm	weight kg
	DN	Inch	Size	mm		max. working pressure MPa	psi	min. burst pressure MPa	psi		
461LT-4	6	1/4	-4	6.4	13	42.5	6160	170.0	24640	75	0.30
461LT-5	8	5/16	-5	7.9	15	40.0	5800	160.0	23200	85	0.35
461LT-6	10	3/8	-6	9.5	17	35.0	5075	140.0	20300	90	0.42
461LT-8	12	1/2	-8	12.7	21	31.0	4495	124.0	17980	130	0.52
461LT-10	16	5/8	-10	15.9	24	28.0	4060	112.0	16240	160	0.66
461LT-12	19	3/4	-12	19.1	28	28.0	4060	112.0	16240	195	0.86
461LT-16	25	1	-16	25.4	35	21.0	3045	84.0	12180	250	1.17

The combination of high temperature and high pressure could reduce the hose life.

Hose layline example



462

Elite No-Skive Compact

Exceeds EN 857-2SC – ISO 11237 Type 2SC

Primary Applications

Demanding medium pressure hydraulic applications in all markets

Type Approvals

Details please find on pages **Ab-16** to **Ab-19**

Applicable Specifications

Exceed EN 857-2SC – ISO 11237 Type 2SC

Construction

Inner tube: Nitrile (NBR)
Reinforcement: Two high-tensile steel wire braids
Cover: Synthetic rubber

Temperature Range -40 °C up to +100 °C

Exception: Air max. +70 °C
Water max. +85 °C



- **No-Skive** hose construction – Compact design
- Nitrile (NBR) inner tube – extended fluid compatibility
- Exceeding EN/ISO specifications for pressure, bend radius and abrasion resistance

Recommended Fluids

Hydraulic fluids on a mineral-oil basis, water-glycol and lubricating oils, air and water. For air and gas applications with a pressure exceeding 1.7 MPa, the cover must be pin-pricked. Consult the chemical compatibility section on pages **Ab-26** to **Ab-34** for more detailed information.

Fitting Series

Size -4 up to -16
Size -20



Part Number	Hose I.D.				Hose O.D. mm	Pressure Rating				min. bend radius mm	weight kg
	DN	Inch	Size	mm		max. working pressure		min. burst pressure			
						MPa	psi	MPa	psi		
462-4	6	1/4	-4	6.4	13.4	42.5	6160	170.0	24640	75	0.30
462-5	8	5/16	-5	7.9	15.0	40.0	5800	160.0	23200	85	0.35
462-6	10	3/8	-6	9.5	17.2	35.0	5075	140.0	20300	90	0.42
462-8	12	1/2	-8	12.7	20.4	31.0	4495	124.0	17980	130	0.52
462-10	16	5/8	-10	15.9	23.9	28.0	4060	112.0	16240	160	0.66
462-12	19	3/4	-12	19.1	27.7	28.0	4060	112.0	16240	195	0.86
462-16	25	1	-16	25.4	35.4	21.0	3045	84.0	12180	250	1.17
462-20	31	1 1/4	-20	31.8	45.1	17.2	2495	68.8	9980	335	1.80

The combination of high temperature and high pressure could reduce the hose life.
From size -4 to -16, smooth cover, 462-20 wrapped cover
Also available in reels up to size -12 under part number 462-xx-RL

Hose layline example



462PU

No-Skive Compact

Polyurethane Cover

Primary Applications

For truck cranes and lifting equipment such as forklift trucks, aerial lifts, cranes, telehandlers, lifting platforms. Ideal for over-the-sheave or reel applications. The best solution for all the demanding medium pressure hydraulic applications in all markets, especially mobile and construction equipment.

Applicable Specifications

Exceed EN 857 2SC - ISO 11237 type 2SC

Construction

Inner tube: Nitrile (NBR)
Reinforcement: Two high-tensile steel wire braids
Cover: Premium-quality polyurethane

Temperature Range -50 °C up to +100 °C

Exception: Air max. +70 °C
Water max. +85 °C

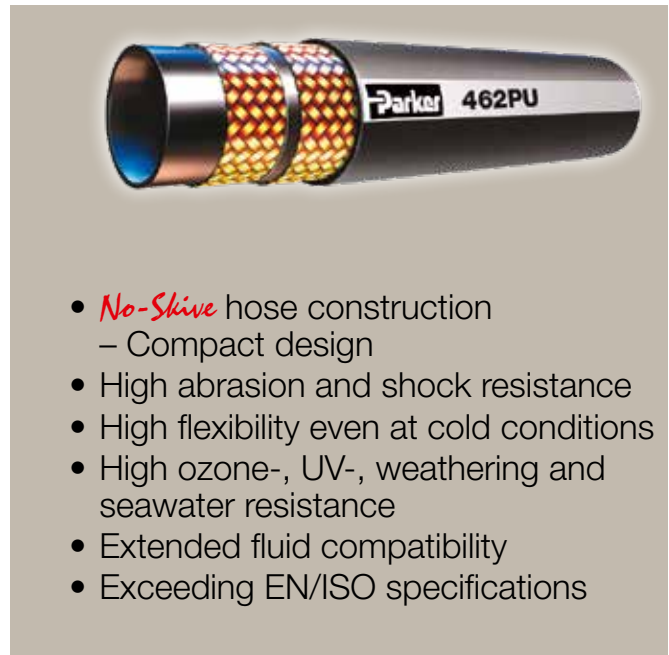

- *No-Skive* hose construction – Compact design
- High abrasion and shock resistance
- High flexibility even at cold conditions
- High ozone-, UV-, weathering and seawater resistance
- Extended fluid compatibility
- Exceeding EN/ISO specifications

Recommended Fluids

Hydraulic fluids on a mineral-oil basis, water-glycol and lubricating oils, air and water. For air and gas applications with a pressure exceeding 1.7 MPa, the cover must be pin-pricked.

Consult the chemical compatibility section on pages **Ab-26** to **Ab-34** for more detailed information.

Fitting Series



Part Number	Hose I.D.				Hose O.D. mm	Pressure Rating				min. bend radius mm	weight kg
	DN	Inch	Size	mm		max. working pressure		min. burst pressure			
						MPa	psi	MPa	psi		
462PU-4	6	1/4	4	6,4	13,4	42,5	6160	170,0	24640	75	0,30
462PU-5	8	5/16	5	7,9	15,0	40,0	5800	160,0	23200	85	0,35
462PU-6	10	3/8	6	9,5	17,2	35,0	5075	140,0	20300	90	0,42
462PU-8	12	1/2	8	12,7	20,4	31,0	4495	124,0	17980	130	0,52
462PU-10	16	5/8	10	15,9	23,9	28,0	4060	112,0	16240	160	0,66

The combination of high temperature and high pressure could reduce the hose life.

Hose layline example

PARKER ELITE 462PU-8 WP 31,0 MPa (4495 psi) | • • 12,5 mm (1/2 ")

462PU Twin

No-Skive Compact

Twin Hose with Polyurethane Cover

Primary Applications

For truck cranes and lifting equipment such as forklift trucks, aerial lifts, cranes, telehandlers, lifting platforms. Ideal for over-the-sheave or reel applications. The best solution for all the demanding medium pressure hydraulic applications in all markets, especially mobile and construction equipment.

Applicable Specifications

Exceed EN 857 2SC - ISO 11237 type 2SC

Construction

Inner tube: Nitrile (NBR)
Reinforcement: Two high-tensile steel wire braids
Cover: Premium-quality polyurethane

Temperature Range -50 °C up to +100 °C

Exception: Air max. +70 °C
Water max. +85 °C



- **No-Skive** hose construction – Compact design
- High abrasion and shock resistance
- High flexibility even at cold conditions
- High ozone-, UV-, weathering and seawater resistance
- Extended fluid compatibility
- Exceeding EN/ISO specifications

Recommended Fluids

Hydraulic fluids on a mineral-oil basis, water-glycol and lubricating oils, air and water. For air and gas applications with a pressure exceeding 1.7 MPa, the cover must be pin-pricked.

Consult the chemical compatibility section on pages **Ab-26** to **Ab-34** for more detailed information.

Fitting Series



Part Number	Hose I.D.				Hose O.D. mm	Pressure Rating				min. bend radius mm	weight kg
	DN	Inch	Size	mm		max. working pressure		min. burst pressure			
						MPa	psi	MPa	psi		
462PU-4-4	6	1/4	4	6.4	28.2	42.5	6160	170.0	24640	75	0.60
462PU-5-5	8	5/16	5	7.9	32.5	40.0	5800	160.0	23200	85	0.70
462PU-6-6	10	3/8	6	9.5	35.0	35.0	5075	140.0	20300	90	0.85
462PU-8-8	12	1/2	8	12.7	41.5	31.0	4495	124.0	17980	130	1.00
462PU-10-10	16	5/8	10	15.9	48.7	28.0	4060	112.0	16240	160	1.35

The combination of high temperature and high pressure could reduce the hose life.

Hose layline example



462TC

Elite No-Skive Compact Tough Cover

Exceeds EN 857-2SC – ISO 11237 Type 2SC

Primary Applications

Demanding medium pressure hydraulic applications in all markets

Type Approvals

Details please find on pages **Ab-16** to **Ab-19**

Applicable Specifications

Exceed EN 857-2SC – ISO 11237 Type 2SC

Construction

Inner tube: Nitrile (NBR)
Reinforcement: Two high-tensile steel wire braids
Cover: Highly abrasion resistance
MSHA approved

Temperature Range

..... -40 °C up to +100 °C
Exception: Air max. +70 °C
Water max. +85 °C



- **No-Skive** hose construction – Compact design
- Nitrile (NBR) inner tube – extended fluid compatibility
- Exceeding EN/ISO specifications for pressure, bend radius and abrasion resistance
- Highly abrasion resistant **TOUGH COVER**
- MSHA approved

Recommended Fluids

Hydraulic fluids on a mineral-oil basis, water-glycol and lubricating oils, air and water. For air and gas applications with a pressure exceeding 1.7 MPa, the cover must be pin-pricked. Consult the chemical compatibility section on pages **Ab-26** to **Ab-34** for more detailed information.

Fitting Series

Size -4 up to -16



Size -20 up to -32



Size -40 up to -48

2piece 48

Part Number	Hose I.D.				Hose O.D. mm	Pressure Rating				min. bend radius mm	weight kg
	DN	Inch	Size	mm		max. working pressure MPa	psi	min. burst pressure MPa	psi		
462TC-4	6	1/4	-4	6.4	13.4	42.5	6160	170.0	24640	75	0.30
462TC-5	8	5/16	-5	7.9	15.0	40.0	5800	160.0	23200	85	0.35
462TC-6	10	3/8	-6	9.5	17.2	35.0	5075	140.0	20300	90	0.42
462TC-8	12	1/2	-8	12.7	20.4	31.0	4495	124.0	17980	130	0.52
462TC-10	16	5/8	-10	15.9	23.9	28.0	4060	112.0	16240	160	0.66
462TC-12	19	3/4	-12	19.1	27.7	28.0	4060	112.0	16240	195	0.86
462TC-16	25	1	-16	25.4	35.4	21.0	3045	84.0	12180	250	1.17
462TC-20 *	31	1 1/4	-20	31.8	45.1	17.2	2495	68.8	9980	335	1.80
462TC-24 *	38	1 1/2	-24	38.1	52.0	14.6	2118	58.4	8472	400	2.20
462TC-32 *	51	2	-32	50.8	64.0	11.2	1624	44.8	6496	500	2.90
462TC-40 **	63	2 1/2	-40	63.5	76.0	7.0	1015	28.0	4060	760	3.00
462TC-48 **	76	3	-48	76.2	87.5	7.0	1015	28.0	4060	760	3.30

The combination of high temperature and high pressure could reduce the hose life.

* Size -20 up to -32 only with fitting series 48

** Size -40 up to -48 only with 2piece fitting series 48

Hose layline example

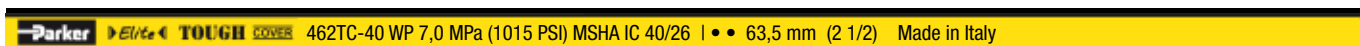

462ST

Elite No-Skive Super Tough Compact

EN 857 2SC – ISO 11237 Type 2SC



- **No-Skive** hose construction – Compact design
- Nitrile (NBR) inner tube – extended fluid compatibility
- Extreme abrasion resistant **SUPER TOUGH** cover
- Exceeding EN/ISO specifications for pressure, bend radius and abrasion resistance

Primary Applications

Mobile market: Medium pressure hydraulic applications with extremely high abrasion risks

Applicable Specifications

EN 857 2SC – ISO 11237 Type 2SC

Construction

Inner tube: Nitrile (NBR)
Reinforcement: Two high-tensile steel wire braids
Cover: Synthetic rubber with a special polyethylene coating

Temperature Range -40 °C up to +100 °C

Exception: Air max. +70 °C
Water max. +85 °C

Recommended Fluids

Hydraulic fluids on a mineral-oil basis, water-glycol and lubricating oils, air and water. For air and gas applications with a pressure exceeding 1.7 MPa, the cover must be pin-pricked. Consult the chemical compatibility section on pages **Ab-26** to **Ab-34** for more detailed information.

Fitting Series

Size -4 up to -16

Size -20



Part Number	Hose I.D.				Hose O.D. mm	Pressure Rating				min. bend radius mm	weight kg
	DN	Inch	Size	mm		max. working pressure MPa	psi	min. burst pressure MPa	psi		
462ST-4	6	1/4	-4	6.4	13.4	42.5	6160	170.0	24640	75	0.30
462ST-5	8	5/16	-5	7.9	15.0	40.0	5800	160.0	23200	85	0.35
462ST-6	10	3/8	-6	9.5	17.2	35.0	5075	140.0	20300	90	0.42
462ST-8	12	1/2	-8	12.7	20.4	31.0	4495	124.0	17980	125	0.52
462ST-10	16	5/8	-10	15.9	23.9	28.0	4060	112.0	16240	160	0.66
462ST-12	19	3/4	-12	19.1	27.7	28.0	4060	112.0	16240	195	0.86
462ST-16	25	1	-16	25.4	35.4	21.0	3045	84.0	12180	250	1.17
462ST-20 *	31	1 1/4	-20	31.8	45.1	17.2	2495	68.8	9980	335	1.80

The combination of high temperature and high pressure could reduce the hose life.
* 462ST-20 only with fitting series 48

Hose layline example



463

No-Skive Compact

High pressure water cleaning applications



- 2 wire *No-Skive* Compact design
- For water up to +120 °C constant temperature

Primary Applications

High pressure water cleaners

Construction

Inner tube: Synthetic rubber
Reinforcement: Two high-tensile steel wire braids
Cover: Synthetic rubber , black or blue

Temperature RangeWater max. +120 °C

Fitting Series



Part Number	Hose I.D.				Hose O.D. mm	Pressure Rating				min. bend radius mm	weight kg
	DN	Inch	Size	mm		max. working pressure		min. burst pressure			
						MPa	psi	MPa	psi		
463-5	8	5/16	-5	7.9	15.0	40.0	5800	120.0	17400	75	0.31
463-5-BLU	8	5/16	-5	7.9	15.0	40.0	5800	120.0	17400	75	0.31
463-6	10	3/8	-6	9.5	17.4	40.0	5800	120.0	17400	90	0.38
463-6-BLU	10	3/8	-6	9.5	17.4	40.0	5800	120.0	17400	90	0.38
463-8	12	1/2	-8	12.7	20.6	35.0	5075	105.0	15225	110	0.48
463-8-BLU	12	1/2	-8	12.7	20.6	35.0	5075	105.0	15225	110	0.48

WKS rubber hand grip for No-Skive high pressure water cleaning hoses can be found on page Eb-20.
The combination of high temperature and high pressure could reduce the hose life.
Also available on reels under part number 463-xx-RL

Hose layline example



471TC

No-Skive

EN 857 2SC – ISO 11237 Type 2SC

Primary Applications

Small bending radii demanding medium pressure hydraulic applications

Type Approvals

Details please find on pages **Ab-16** to **Ab-19**

Applicable Specifications

EN 857 2SC – ISO 11237 Type 2SC

Construction

- Inner tube: Synthetic rubber
- Reinforcement: Two high-tensile steel wire braids
- Cover: Highly abrasion resistance
MSHA approved

Temperature Range -40 °C up to +100 °C

- Exception: Air max. +70 °C
- Water max. +85 °C



- *No-Skive* hose construction
– Compact design
- Reduced bend radii
- Highly abrasion resistant **TOUGH COVER**
- MSHA approved
- Hose is suitable for temporary immersion in mineral oil up to 70 °C with frequent inspections

Recommended Fluids

Hydraulic fluids on a mineral-oil basis, water-glycol and lubricating oils, air and water. For air and gas applications with a pressure exceeding 1.7 MPa, the cover must be pin-pricked.

Consult the chemical compatibility section on pages **Ab-26** to **Ab-34** for more detailed information.

Fitting Series



Part Number	Hose I.D.				Hose O.D. mm	Pressure Rating				min. bend radius mm	weight kg
	DN	Inch	Size	mm		max. working pressure MPa	psi	min. burst pressure MPa	psi		
471TC-4	6	1/4	-4	6.4	13	40.0	5800	160.0	23200	50	0.30
471TC-5	8	5/16	-5	7.9	15	36.0	5250	144.0	21000	55	0.35
471TC-6	10	3/8	-6	9.5	17	35.0	5075	140.0	20000	65	0.42
471TC-8	12	1/2	-8	12.7	20	29.7	4250	119.0	17000	90	0.52
471TC-10	16	5/8	-10	15.9	24	25.0	3625	100.0	14500	100	0.66
471TC-12	19	3/4	-12	19.1	28	21.5	3125	86.0	12500	120	0.86
471TC-16	25	1	-16	25.4	35	17.5	2500	70.0	10000	150	1.17

Replace the hose when any deformation or damages on the hose cover are visible. The combination of high temperature and high pressure could reduce the hose life.

Hose layline example

Parker TOUGH COVER 471TC-8 WP 29,7 MPa (4250 PSI) MSHA IC-40/26 — — . . . ISO11237/EN



477

Elite No-Skive PowerLift

2 wire braided

Primary Applications

For truck cranes and lifting equipment such as fork lift trucks, aerial lifts, cranes, telehandlers, lifting platforms.

Restrictions

Should not be used for high impulse hydraulic applications to replace spiral construction hoses.

Construction

Inner tube: Nitrile (NBR)
Reinforcement: Two high-tensile steel wire braids
Cover: Synthetic rubber

Temperature Range -40 °C up to +100 °C

Exception: Air max. +70 °C
Water max. +85 °C



- *No-Skive* hose construction – Compact design
- Smaller bend radius and reduced outside diameter bringing a significant advantage in terms of space and weight on compact equipment

Recommended Fluids

Hydraulic fluids on a mineral-oil basis, water-glycol and lubricating oils, air and water. For air and gas applications with a pressure exceeding 1.7 MPa, the cover must be pin-pricked.

Consult the chemical compatibility section on pages **Ab-26** to **Ab-34** for more detailed information.

Fitting Series



Part Number	Hose I.D.				Hose O.D. mm	Pressure Rating				min. bend radius mm	weight kg
	DN	Inch	Size	mm		max. working pressure MPa	psi	min. burst pressure MPa	psi		
477-4	6	1/4	-4	6.4	13.1	45.0	6500	180.0	26000	65	0.32
477-5	8	5/16	-5	7.9	14.9	42.5	6100	170.0	24400	70	0.35
477-6	10	3/8	-6	9.5	17.2	40.0	5800	160.0	23200	75	0.42
477-8	12	1/2	-8	12.7	20.4	38.0	5500	152.0	22000	105	0.55
477-10	16	5/8	-10	15.9	23.4	35.0	5000	140.0	20000	160	0.65
477-12	19	3/4	-12	19.1	27.2	35.0	5000	140.0	20000	200	1.10
477-16	25	1	-16	25.4	34.8	28.0	4000	112.0	16000	250	1.34

The combination of high temperature and high pressure could reduce the hose life.

Hose layline example



477RH

Elite No-Skive

2 wire braided with fire-retardant cover

Primary Applications

For general medium pressure hydraulic and demanding bending radii applications such as lifting equipment.

Type Approvals

Details please find on pages **Ab-16** to **Ab-19**

Restrictions

Should not be used for high impulse hydraulic applications to replace spiral construction hoses.

Construction

Inner Tube: Nitrile (NBR)
Reinforcement: Two high-tensile steel wire braids
Cover: Fire retardant synthetic rubber

Temperature Range -40 °C up to +100 °C

Exception: Air max. +70 °C
Water max. +85 °C



- *No-Skive* hose construction – Compact design
- Smaller bend radius and reduced outside diameter
- Fire-retardant cover
- Railway approved:
 - European Standard EN45545 HL2 for R22 (internal) and HL3 for R23 (external)

Recommended Fluids

Hydraulic fluids on a mineral-oil basis, water-glycol and lubricating oils, air and water. For air and gas applications with a pressure exceeding 1.7 MPa, the cover must be pin-pricked.

Consult the chemical compatibility section on pages **Ab-26** to **Ab-34** for more detailed information.

Fitting Series



Part Number	Hose I.D.				Hose O.D. mm	Pressure Rating				min. bend radius mm	weight kg
	DN	Inch	Size	mm		max. working pressure MPa	psi	min. burst pressure MPa	psi		
477RH-4	6	1/4	-4	6.4	13.1	45.0	6500	180.0	26000	65	0.32
477RH-5	8	5/16	-5	7.9	14.9	42.5	6100	170.0	24400	70	0.35
477RH-6	10	3/8	-6	9.5	17.2	40.0	5800	160.0	23200	75	0.42
477RH-8	12	1/2	-8	12.7	20.4	38.0	5500	152.0	22000	105	0.55
477RH-10	16	5/8	-10	15.9	23.4	35.0	5000	140.0	20000	160	0.65
477RH-12	19	3/4	-12	19.1	27.2	35.0	5000	140.0	20000	200	1.10
477RH-16	25	1	-16	25.4	34.8	28.0	4000	112.0	16000	250	1.34

The combination of high temperature and high pressure could reduce the hose life.

Hose layline example



477TC

Elite No-Skive PowerLift Tough Cover

2 wire braided

Primary Applications

For truck cranes and lifting equipment such as fork lift trucks, aerial lifts, cranes, telehandlers, lifting platforms.

Restrictions

Should not be used for high impulse hydraulic applications to replace spiral construction hoses.

Construction

Inner tube: Nitrile (NBR)
Reinforcement: Two high-tensile steel wire braids
Cover: Highly abrasion resistance
MSHA approved

Temperature Range -40 °C up to +100 °C

Exception: Air max. +70 °C
Water max. +85 °C



- **No-Skive** hose construction – Compact design
- Smaller bend radius and reduced outside diameter bringing a significant advantage in terms of space and weight on compact equipment
- Highly abrasion resistant **TOUGH COVER**
- MSHA approved
- Hose is suitable for temporary immersion in mineral oil up to 70 °C with frequent inspections

Recommended Fluids

Hydraulic fluids on a mineral-oil basis, water-glycol and lubricating oils, air and water. For air and gas applications with a pressure exceeding 1.7 MPa, the cover must be pin-pricked.

Consult the chemical compatibility section on pages **Ab-26** to **Ab-34** for more detailed information.

Fitting Series



Part Number	Hose I.D.				Hose O.D. mm	Pressure Rating				min. bend radius mm	weight kg
	DN	Inch	Size	mm		max. working pressure		min. burst pressure			
						MPa	psi	MPa	psi		
477TC-4	6	1/4	-4	6.4	13.1	45.0	6500	180.0	26000	65	0.32
477TC-5	8	5/16	-5	7.9	14.9	42.5	6100	170.0	24400	70	0.35
477TC-6	10	3/8	-6	9.5	17.2	40.0	5800	160.0	23200	75	0.42
477TC-8	12	1/2	-8	12.7	20.4	38.0	5500	152.0	22000	105	0.55
477TC-10	16	5/8	-10	15.9	23.4	35.0	5000	140.0	20000	160	0.65
477TC-12	19	3/4	-12	19.1	27.2	35.0	5000	140.0	20000	200	1.10
477TC-16	25	1	-16	25.4	34.8	28.0	4000	112.0	16000	250	1.34

The combination of high temperature and high pressure could reduce the hose life.

Hose layline example



477ST

Elite No-Skive PowerLift

2 wire braided

Primary Applications

For truck cranes and lifting equipment such as fork lift trucks, aerial lifts, cranes, telehandlers, lifting platforms.

Restrictions

Should not be used for high impulse hydraulic applications to replace spiral construction hoses.

Construction

Inner tube: Nitrile (NBR)
Reinforcement: Two high-tensile steel wire braids
Cover: Synthetic rubber with a special polyethylene coating

Temperature Range -40 °C up to +100 °C

Exception: Air max. +70 °C

Water max. +85 °C



- *No-Skive* hose construction – Compact design
- Extreme abrasion resistant **SUPER TOUGH** cover
- Smaller bend radius and reduced outside diameter

Recommended Fluids

Hydraulic fluids on a mineral-oil basis, water-glycol and lubricating oils, air and water. For air and gas applications with a pressure exceeding 1.7 MPa, the cover must be pin-pricked.

Consult the chemical compatibility section on pages **Ab-26** to **Ab-34** for more detailed information.

Fitting Series



Part Number	Hose I.D.				Hose O.D. mm	Pressure Rating				min. bend radius mm	weight kg
	DN	Inch	Size	mm		max. working pressure MPa	psi	min. burst pressure MPa	psi		
477ST-4	6	1/4	-4	6.4	13.1	45.0	6500	180.0	26000	65	0.30
477ST-5	8	5/16	-5	7.9	14.9	42.5	6100	170.0	24400	70	0.35
477ST-6	10	3/8	-6	9.5	17.2	40.0	5800	160.0	23200	75	0.42
477ST-8	12	1/2	-8	12.7	20.4	38.0	5500	152.0	22000	105	0.55
477ST-10	16	5/8	-10	15.9	23.4	35.0	5000	140.0	20000	160	0.65
477ST-12	19	3/4	-12	19.1	27.2	35.0	5000	140.0	20000	200	1.20
477ST-16	25	1	-16	25.4	34.8	28.0	4000	112.0	16000	250	1.34

The combination of high temperature and high pressure could reduce the hose life.

Hose layline example



492

Elite No-Skive Compact

EN 857 1SC – ISO 11237 Type 1SC



- *No-Skive* hose construction
– Compact design
- Nitrile (NBR) inner tube
– extended fluid compatibility
- Exceeding EN/ISO specifications for pressure, bend radius and abrasion resistance

Primary Applications

Demanding medium pressure hydraulic applications

Type Approvals

Details please find on pages **Ab-16** to **Ab-19**

Applicable Specifications

EN 857 1SC – ISO 11237 Type 1SC

Construction

Inner tube: Nitrile (NBR)
Reinforcement: One high-tensile steel wire braid
Cover: Synthetic rubber

Temperature Range -40 °C up to +100 °C

Exception: Air max. +70 °C
Water max. +85 °C

Recommended Fluids

Hydraulic fluids on a mineral-oil basis, water-glycol and lubricating oils, air and water. For air and gas applications with a pressure exceeding 1.7 MPa, the cover must be pin-pricked.

Consult the chemical compatibility section on pages **Ab-26** to **Ab-34** for more detailed information.

Fitting Series



Part Number	Hose I.D.				Hose O.D. mm	Pressure Rating				min. bend radius mm	weight kg
	DN	Inch	Size	mm		max. working pressure MPa	psi	min. burst pressure MPa	psi		
492-4	6	1/4	-4	6.4	11.5	28.0	4060	112.0	16240	75	0.18
492-5	8	5/16	-5	7.9	13.6	25.0	3625	100.0	14500	85	0.21
492-6	10	3/8	-6	9.5	15.5	22.5	3260	90.0	13050	90	0.25
492-8	12	1/2	-8	12.7	18.9	19.0	2755	76.0	11020	130	0.33
492-10	16	5/8	-10	15.9	22.2	15.0	2175	60.0	8700	150	0.41
492-12	19	3/4	-12	19.1	26.0	15.0	2175	60.0	8700	180	0.56
492-16	25	1	-16	25.4	33.3	11.0	1595	44.0	6380	230	0.75
492-20-WR	31	1 1/4	-20	31.8	40.0	7.5	1085	30.0	4350	335	0.93

Part Number without a suffix: the hose cover has a smooth appearance. Part Number with a suffix (WR): the hose cover has a wrapped appearance. The combination of high temperature and high pressure could reduce the hose life. Also available in reels up to size -16 under part number 492-xx-RL

Hose layline example



492TC

Elite No-Skive Compact Tough Cover

EN 857 1SC – ISO 11237 Type 1SC

Primary Applications

Demanding medium pressure hydraulic applications

Type Approvals

Details please find on pages **Ab-16** to **Ab-19**

Applicable Specifications

EN 857 1SC – ISO 11237 Type 1SC

Construction

- Inner tube: Nitrile (NBR)
- Reinforcement: One high-tensile steel wire braid
- Cover: Highly abrasion resistance
MSHA approved

Temperature Range -40 °C up to +100 °C

- Exception: Air max. +70 °C
- Water max. +85 °C



- **No-Skive** hose construction
– Compact design
- Nitrile (NBR) inner tube
– extended fluid compatibility
- Exceeding EN/ISO specifications for pressure, bend radius and abrasion resistance
- Highly abrasion resistant **TOUGH COVER**
- MSHA approved
- Hose is suitable for temporary immersion in mineral oil up to 70 °C with frequent inspections

Recommended Fluids

Hydraulic fluids on a mineral-oil basis, water-glycol and lubricating oils, air and water. For air and gas applications with a pressure exceeding 1.7 MPa, the cover must be pin-pricked.

Consult the chemical compatibility section on pages **Ab-26** to **Ab-34** for more detailed information.

Fitting Series



Part Number	Hose I.D.				Hose O.D. mm	Pressure Rating				min. bend radius mm	weight kg
	DN	Inch	Size	mm		max. working pressure MPa	psi	min. burst pressure MPa	psi		
492TC-4	6	1/4	-4	6.4	11.5	28.0	4060	112.0	16240	75	0.18
492TC-5	8	5/16	-5	7.9	13.6	25.0	3625	100.0	14500	85	0.21
492TC-6	10	3/8	-6	9.5	15.5	22.5	3260	90.0	13050	90	0.25
492TC-8	12	1/2	-8	12.7	18.9	19.0	2755	76.0	11020	130	0.33
492TC-10	16	5/8	-10	15.9	22.2	15.0	2175	60.0	8700	150	0.41
492TC-12	19	3/4	-12	19.1	26.0	15.0	2175	60.0	8700	180	0.56
492TC-16	25	1	-16	25.4	33.3	11.0	1595	44.0	6380	230	0.75

The combination of high temperature and high pressure could reduce the hose life.

Hose layline example

PARKER NO-SKIVE Tough Cover 492TC-8 WP 19,0 MPa (2755 PSI) MSHA | • • 12,7 mm (1/2) Made in Italy



492ST

Elite No-Skive Super Tough Compact

EN 857 1SC – ISO 11237 Type 1SC



- *No-Skive* hose construction
– Compact design
- Nitrile (NBR) inner tube
– extended fluid compatibility
- Extreme abrasion resistant
SUPER TOUGH cover
- Exceeding EN/ISO specifications for pressure, bend radius and abrasion resistance

Primary Applications

Mobile market: Medium pressure hydraulic applications with extremely high abrasion risks

Applicable Specifications

EN 857 1SC – ISO 11237 Type 1SC

Construction

Inner tube: Nitrile (NBR)
Reinforcement: One high-tensile steel wire braid
Cover: Synthetic rubber with a special polyethylene coating

Temperature Range -40 °C up to +100 °C

Exception: Air max. +70 °C
Water max. +85 °C

Recommended Fluids

Hydraulic fluids on a mineral-oil basis, water-glycol and lubricating oils, air and water. For air and gas applications with a pressure exceeding 1.7 MPa, the cover must be pin-pricked.

Consult the chemical compatibility section on pages **Ab-26** to **Ab-34** for more detailed information.

Fitting Series



Part Number	Hose I.D.				Hose O.D. mm	Pressure Rating				min. bend radius mm	weight kg
	DN	Inch	Size	mm		max. working pressure MPa	psi	min. burst pressure MPa	psi		
492ST-4	6	1/4	-4	6.4	12.0	28.0	4000	112.0	16240	75	0.18
492ST-5	8	5/16	-5	7.9	13.6	25.0	3625	100.0	14500	85	0.21
492ST-6	10	3/8	-6	9.5	15.5	22.5	3260	90.0	13050	90	0.25
492ST-8	12	1/2	-8	12.7	18.9	19.0	2755	76.0	11020	130	0.33
492ST-10	16	5/8	-10	15.9	22.3	15.0	2175	60.0	8700	150	0.41
492ST-12	19	3/4	-12	19.1	26.0	15.0	2175	60.0	8700	180	0.56
492ST-16	25	1	-16	25.4	33.6	11.0	1595	44.0	6380	230	0.75
492ST-20	31	1 1/4	-20	31.8	40.0	7.5	1085	30.0	4350	335	0.93

The combination of high temperature and high pressure could reduce the hose life.

Hose layline example



493

No-Skive Compact

High pressure water cleaning applications



- One wire *No-Skive* construction
- For water up to +120 °C constant temperature

Primary Applications

High pressure water cleaners

Construction

Inner tube: Synthetic rubber

Reinforcement: One high-tensile steel wire braid

Cover: Synthetic rubber , black or blue

Temperature RangeWater max. +120 °C

Fitting Series



Part Number	Hose I.D.				Hose O.D. mm	Pressure Rating				min. bend radius mm	weight kg
	DN	Inch	Size	mm		max. working pressure		min. burst pressure			
						MPa	psi	MPa	psi		
493-4	6	1/4	-4	6.4	13.4	20.0	2898	60.0	8695	60	0.18
493-4-BLU	6	1/4	-4	6.4	13.4	20.0	2898	60.0	8695	60	0.18
493-5	8	5/16	-5	7.9	15.0	20.0	2898	60.0	8695	75	0.21
493-5-BLU	8	5/16	-5	7.9	15.0	20.0	2898	60.0	8695	75	0.21
493-6	10	3/8	-6	9.5	17.4	20.0	2898	60.0	8695	90	0.25
493-6-BLU	10	3/8	-6	9.5	17.4	20.0	2898	60.0	8695	90	0.25
493-8	12	1/2	-8	12.7	20.6	17.5	2536	52.5	7608	110	0.33
493-8-BLU	12	1/2	-8	12.7	20.6	17.5	2536	52.5	7608	110	0.33

WKS rubber hand grip for No-Skive high pressure water cleaning hoses can be found on page Eb-20.
The combination of high temperature and high pressure could reduce the hose life.
Also available on reels under part number 493-xx-RL

Hose layline example



692

No-Skive Compact

Constant pressure, tight bend radius

Primary Applications

Material handling:

General small bending radii hydraulic applications, ideal for over the sheave or reel applications.

Applicable Specifications

Parker Specification

Construction

Inner tube: Nitrile (NBR)

Reinforcement: One or two high-tensile steel wire braids

Cover: Synthetic rubber

Temperature Range -40 °C up to +100 °C

Exception: Air max. +70 °C



- *No-Skive* hose construction – Compact design
- Nitrile (NBR) inner tube – extended fluid compatibility
- Constant working pressure of 21.0 MPa

Recommended Fluids

Hydraulic fluids on a mineral-oil basis, water-glycol and lubricating oils, air and water. For air and gas applications with a pressure exceeding 1.7 MPa, the cover must be pin-pricked.

Consult the chemical compatibility section on pages **Ab-26** to **Ab-34** for more detailed information.

Fitting Series



Part Number	Hose I.D.				Hose O.D. mm	Pressure Rating				min. bend radius mm	weight kg
	DN	Inch	Size	mm		max. working pressure MPa	psi	min. burst pressure MPa	psi		
692-4	6	1/4	-4	6.4	11.5	21.0	3045	84.0	12180	40	0.18
692-5	8	5/16	-5	7.9	13.6	21.0	3045	84.0	12180	40	0.21
692-6	10	3/8	-6	9.5	15.5	21.0	3045	84.0	12180	40	0.25
692-8	12	1/2	-8	12.7	20.4	21.0	3045	84.0	12180	50	0.52
692-10	16	5/8	-10	15.9	23.9	21.0	3045	84.0	12180	60	0.66

The combination of high temperature and high pressure could reduce the hose life.

Hose layline example

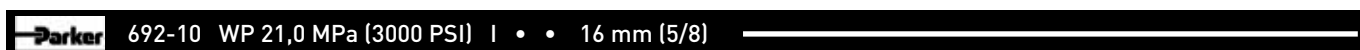

692Twin

No-Skive Compact

Twin constant pressure, tight bend radius

Primary Applications

Lifting and material handling equipment:
General small bending radii hydraulic applications, ideal over the sheave or reel applications

Applicable Specifications

Parker Specification

Construction

Inner tube: Nitrile (NBR)
Reinforcement: One or two high-tensile steel wire braids
Cover: Synthetic rubber

Temperature Range -40 °C up to +100 °C

Exception: Air max. +70 °C



- **No-Skive** hose construction
– Compact design
- Nitrile (NBR) inner tube
– extended fluid compatibility
- Constant working pressure of 21.0 MPa

Recommended Fluids

Hydraulic fluids on a mineral-oil basis, water-glycol and lubricating oils, air and water. For air and gas applications with a pressure exceeding 1.7 MPa, the cover must be pin-pricked.

Consult the chemical compatibility section on pages **Ab-26** to **Ab-34** for more detailed information.

Fitting Series



Part Number	Hose I.D.				Hose O.D. mm	Pressure Rating				min. bend radius mm	weight kg
	DN	Inch	Size	mm		max. working pressure MPa	psi	min. burst pressure MPa	psi		
692-4-4	6	1/4	-4	6.4	25.8	21.0	3045	84.0	12180	40	0.34
692-5-5	8	5/16	-5	7.9	27.4	21.0	3045	84.0	12180	40	0.40
692-6-6	10	3/8	-6	9.5	31.2	21.0	3045	84.0	12180	40	0.48

The combination of high temperature and high pressure could reduce the hose life.

Hose layline example



692PU

No-Skive Compact

Polyurethane Cover

Primary Applications

Material handling industry, where tight bend radii, flexibility, ozone, abrasion and shock resistance are needed and required. Ideal for over-the-sheave or reel applications.

Applicable Specifications

Parker Specification – constant working pressure

Construction

Inner Tube: Nitrile (NBR)
Reinforcement: One or two high-tensile steel wire braids
Cover: Premium-quality polyurethane

Temperature Range -45 °C up to +100 °C

Exception: Air max. +70 °C

Water max. +85 °C

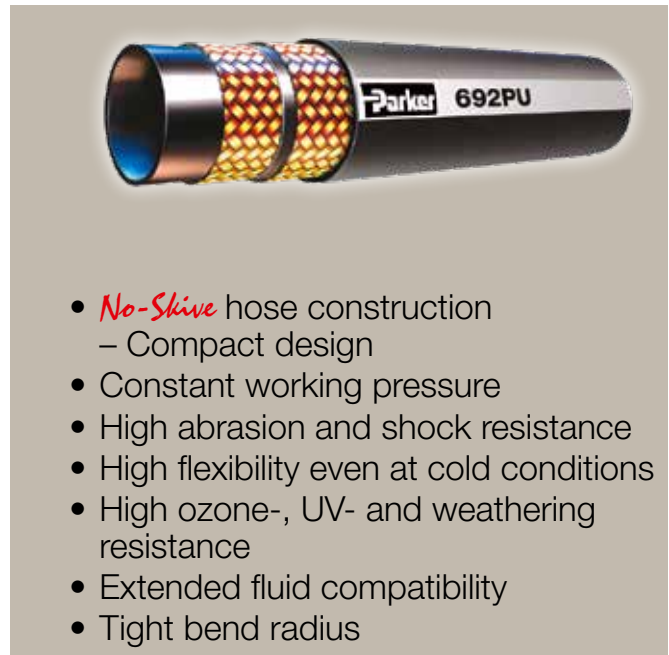

- *No-Skive* hose construction – Compact design
- Constant working pressure
- High abrasion and shock resistance
- High flexibility even at cold conditions
- High ozone-, UV- and weathering resistance
- Extended fluid compatibility
- Tight bend radius

Recommended Fluids

Hydraulic fluids on a mineral-oil basis, water-glycol and lubricating oils, air and water. For air and gas applications with a pressure exceeding 1.7 MPa, the cover must be pin-pricked.

Consult the chemical compatibility section on pages **Ab-26** to **Ab-34** for more detailed information.

Fitting Series

Size -4 up to -6

Size -8 up to -10



Part Number	Hose I.D.				Hose O.D. mm	Pressure Rating				min. bend radius mm	weight kg
	DN	Inch	Size	mm		max. working pressure		min. burst pressure			
						MPa	psi	MPa	psi		
692PU-4	6	1/4	4	6.4	11.5	21.0	3045	84.0	12180	40	0.18
692PU-5	8	5/16	5	7.9	13.6	21.0	3045	84.0	12180	40	0.21
692PU-6	10	3/8	6	9.5	15.5	21.0	3045	84.0	12180	40	0.25
692PU-8	12	1/2	8	12.7	20.4	21.0	3045	84.0	12180	50	0.52
692PU-10	16	5/8	10	15.9	23.9	21.0	3045	84.0	12180	60	0.66

The combination of high temperature and high pressure could reduce the hose life.

Hose layline example

PARKER 692PU-6 WP 21,0 MPa (3046 psi) | • • 10 mm (3/8 ")

692PU Twin

No-Skive Compact

Twin Hose with Polyurethane Cover

Primary Applications

Material handling industry, where tight bend radii, flexibility, ozone, abrasion and shock resistance are needed and required. Ideal for over-the-sheave or reel applications.

Applicable Specifications

Parker Specification – constant working pressure

Construction

Inner Tube: Nitrile (NBR)
Reinforcement: One or two high-tensile steel wire braids
Cover: Premium-quality polyurethane

Temperature Range -45 °C up to +100 °C

Exception: Air max. +70 °C
Water max. +85 °C



- *No-Skive* hose construction – Compact design
- Constant working pressure
- High abrasion and shock resistance
- High flexibility even at cold conditions
- High ozone-, UV- and weathering resistance
- Extended fluid compatibility
- Tight bend radius

Recommended Fluids

Hydraulic fluids on a mineral-oil basis, water-glycol and lubricating oils, air and water. For air and gas applications with a pressure exceeding 1.7 MPa, the cover must be pin-pricked.

Consult the chemical compatibility section on pages **Ab-26** to **Ab-34** for more detailed information.

Fitting Series

Size -4 up to -6

Size -8 up to -10



Part Number	Hose I.D.				Hose O.D. mm	Pressure Rating				min. bend radius mm	weight kg
	DN	Inch	Size	mm		max. working pressure		min. burst pressure			
						MPa	psi	MPa	psi		
692PU-4-4	6	1/4	4	6.4	24.0	21.0	3045	84.0	12180	40	0.36
692PU-5-5	8	5/16	5	7.9	27.4	21.0	3045	84.0	12180	40	0.42
692PU-6-6	10	3/8	6	9.5	31.2	21.0	3045	84.0	12180	40	0.50
692PU-8-8	12	1/2	8	12.7	41.5	21.0	3045	84.0	12180	50	1.00
692PU-10-10	16	5/8	10	15.9	48.7	21.0	3045	84.0	12180	60	1.35

The combination of high temperature and high pressure could reduce the hose life.

Hose layline example



692TC

No-Skive Compact Tough Cover

Constant pressure, tight bend radius

Primary Applications

Material handling:
General small bending radii hydraulic applications, ideal for over the sheave or reel applications.

Applicable Specifications

Parker Specification

Construction

Inner Tube: Nitrile (NBR)
Reinforcement: One or two high-tensile steel wire braids
Cover: Highly abrasion resistance
MSHA approved

Temperature Range -40 °C up to +100 °C

Exception: Air max. +70 °C

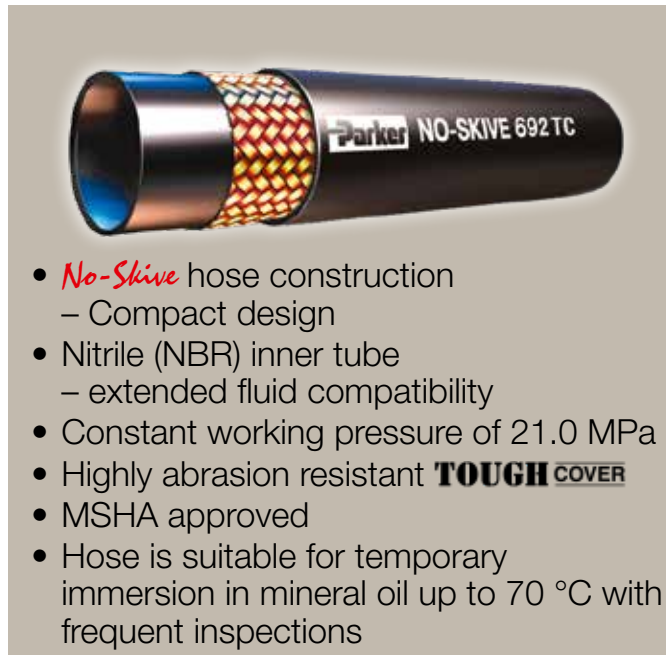

- *No-Skive* hose construction
 - Compact design
- Nitrile (NBR) inner tube
 - extended fluid compatibility
- Constant working pressure of 21.0 MPa
- Highly abrasion resistant **TOUGH COVER**
- MSHA approved
- Hose is suitable for temporary immersion in mineral oil up to 70 °C with frequent inspections

Recommended Fluids

Hydraulic fluids on a mineral-oil basis, water-glycol and lubricating oils, air and water. For air and gas applications with a pressure exceeding 1.7 MPa, the cover must be pin-pricked.

Consult the chemical compatibility section on pages **Ab-26** to **Ab-34** for more detailed information.

Fitting Series



Part Number	Hose I.D.				Hose O.D. mm	Pressure Rating				min. bend radius mm	weight kg
	DN	Inch	Size	mm		max. working pressure		min. burst pressure			
						MPa	psi	MPa	psi		
692TC-4	6	1/4	-4	6.4	11.5	21.0	3045	84.0	12180	40	0.18
692TC-5	8	5/16	-5	7.9	13.6	21.0	3045	84.0	12180	40	0.21
692TC-6	10	3/8	-6	9.5	15.5	21.0	3045	84.0	12180	40	0.25
692TC-8	12	1/2	-8	12.7	20.4	21.0	3045	84.0	12180	50	0.52
692TC-10	16	5/8	-10	15.9	23.9	21.0	3045	84.0	12180	60	0.66

The combination of high temperature and high pressure could reduce the hose life.

Hose layline example

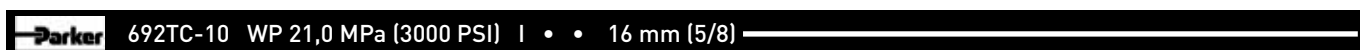

811

No-Skive Suction and Return Line

SAE 100R4



- *No-Skive* hose construction
- Helical wire to prevent collapse under vacuum
- Small bend radii

Primary Applications

All Markets: General applications

Type Approvals

Details please find on pages **Ab-16** to **Ab-19**

Construction

Inner tube: Synthetic rubber
 Reinforcement: Two fibre spiral, one helical wire
 Cover: Synthetic rubber, oil and weather resistant

Recommended Fluids

Hydraulic fluids on a mineral-oil basis, water-glycol and lubricating oils, air and water.
 Consult the chemical compatibility section on pages **Ab-26** to **Ab-34** for more detailed information.

Temperature Range -40 °C up to +100 °C

Exception: Air max. +70 °C
 Water max. +85 °C

Fitting Series

up to size -32



For size -40 and -48

Part Number	Hose I.D.				Hose O.D. mm	Pressure Rating				Vacuum* kPa	min. bend radius mm	weight kg
	DN	Inch	Size	mm		max. working pressure MPa	psi	min. burst pressure MPa	psi			
811-12	19	3/4	-12	19.1	30.0	2.1	300	8.3	1200	85	65	0.63
811-16	25	1	-16	25.4	38.0	1.7	250	6.9	1000	85	75	0.96
811-20	31	1 1/4	-20	31.8	45.0	1.4	200	5.5	800	85	100	1.22
811-24	38	1 1/2	-24	38.1	52.0	1.0	150	4.1	600	85	130	1.55
811-32	51	2	-32	50.8	64.0	0.7	100	2.8	400	85	150	1.87
811-40	63	2 1/2	-40	63.5	75.0	0.4	62	1.6	248	85	180	2.45
811-48	76	3	-48	76.2	90.0	0.4	62	1.6	248	85	230	3.20

* The vacuum values listed in the table are vacuum pressure values in kPa. For an absolute value subtract the table value from 101 kPa.

** size -12 and size -16 = on Parkrimp 2 crimping press or adjustable crimpers only.
 The combination of high temperature and high pressure could reduce the hose life.

Hose layline example

PARKER 811-12 SUCTION HOSE SAE 100R4-12 19 mm (3/4) 3Q81 ————— PARKER 811-12 SUC

811S

No-Skive Suction and Return Line

Exceeds SAE 100R4



- *No-Skive* hose construction
- Helical wire to prevent collapse under vacuum
- Small bend radii
- Isobaric 1.0 MPa for all sizes

Primary Applications

All Markets: General applications

Type Approvals

For size -64 and -80, details please find on pages **Ab-16** to **Ab-19**

Construction

Inner tube: Synthetic rubber
Reinforcement: Two fibre spiral, one helical wire
Cover: Synthetic rubber
oil and weather resistant

Recommended Fluids

Hydraulic fluids on a mineral-oil basis, water-glycol and lubricating oils, air and water.

Consult the chemical compatibility section on pages **Ab-26** to **Ab-34** for more detailed information.

Temperature Range -40 °C up to +100 °C

Exception: Air max. +70 °C
Water max. +85 °C

Fitting Series



Part Number	Hose I.D.		Hose O.D. mm ± 1.6	Pressure Rating				min. bend radius mm
	Size	mm		max. working pressure		min. burst pressure		
			MPa	psi	MPa	psi		
811S-40	-40	63.5	75.0	1.0	145	4.0	580	240
811S-48	-48	76.2	90.0	1.0	145	4.0	580	300
811S-56	-56	88.9	106.0	1.0	145	4.0	580	360
811S-64	-64	101.6	116.0	1.0	145	4.0	580	400
811S-80	-80	127.0	142.0	1.0	145	4.0	580	500
811S-96	-96	152.4	172.0	1.0	145	4.0	580	600

The combination of high temperature and high pressure could reduce the hose life.

Hose layline example

 811S-40 SUCTION AND RETURN LINE HOSE - (MC25) - Exceed SAE 100R4 - 63.5 mm (2"1/2) Q/Y

881

No-Skive Suction and Return Line

SAE 100R4



- *No-Skive* hose construction
- Helical wire to prevent collapse under vacuum
- Up to +121 °C working temperature
- MSHA approved

Primary Applications

All Markets: For high temperature applications
For general applications

Type Approvals

Details please find on pages **Ab-16** to **Ab-19**

Construction

Inner tube: Synthetic rubber
Reinforcement: Two fibre braid, one helical wire
Cover: MSHA approved

Temperature Range -40 °C up to +121 °C

Exception: Air max. +70 °C
Water max. +85 °C

Recommended Fluids

Hydraulic fluids on a mineral-oil basis, water-glycol and lubricating oils, air and water.

Consult the chemical compatibility section on pages **Ab-26** to **Ab-34** for more detailed information.

Fitting Series

Series 43 for sizes -12, -16

Series 48 for sizes -20 up to -32

For size -40 fittings series on request



Part Number	Hose I.D.				Hose O.D. mm	Pressure Rating				Vacuum* kPa	min. bend radius mm	weight kg
	DN	Inch	Size	mm		max. working pressure MPa	psi	min. burst pressure MPa	psi			
881-12	19	3/4	-12	19.1	30.0	2.1	300	8.3	1200	95	130	0.74
881-16	25	1	-16	25.4	38.0	1.7	250	6.9	1000	95	150	0.89
881-20	31	1 1/4	-20	31.8	45.0	1.4	200	5.5	800	95	200	1.32
881-24	38	1 1/2	-24	38.1	52.0	1.0	150	4.1	600	95	250	1.65
881-32	51	2	-32	50.8	63.0	0.7	100	2.8	400	95	300	1.89
881-40	63	2 1/2	-40	63.5	75.0	0.4	62	1.6	248	95	355	2.71

* The vacuum values listed in the table are vacuum pressure values in kPa. For an absolute value subtract the table value from 101kPa. The combination of high temperature and high pressure could reduce the hose life.





Hose layline example

PARKER 881-12 SUCTION HOSE MSHA XXXX SAE 100R4-12 19 mm (3/4) 3Q78 PARKER



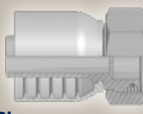

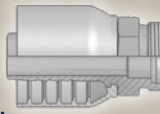
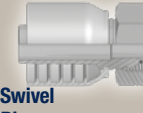
DIN – Metric

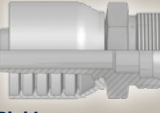
Page Cb-1 – Cb-4

<p>CA Cb-1 Female Metric 24° Light Series with O-Ring Swivel – Straight ISO 12151-2-SWS-L – DKOL</p> 	<p>CE Cb-1 Female Metric 24° Light Series with O-Ring Swivel – 45° Elbow ISO 12151-2-SWE-L – DKOL 45°</p> 	<p>CF Cb-2 Female Metric 24° Light Series with O-Ring Swivel – 90° Elbow ISO 12151-2-SWE-L – DKOL 90°</p> 	<p>D0 Cb-2 Male Metric 24° Light Series – Rigid Straight ISO 12151-2-S-L – CEL</p> 
<p>C9 Cb-3 Female Metric 24° – Swivel Heavy Series with O-Ring Straight ISO 12151-2-SWS-S – DKOS</p> 	<p>OC Cb-3 Female Metric 24° – Swivel Heavy Series with O-Ring 45° Elbow ISO 12151-2-SWE-S – DKOS 45°</p> 	<p>1C Cb-4 Female Metric 24° – Swivel Heavy Series with O-Ring 90° Elbow ISO 12151-2-SWE-S – DKOS 90°</p> 	<p>D2 Cb-4 Male Metric 24° – Rigid Heavy Series – Straight ISO 12151-2-S-S – CES</p> 

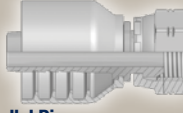

BSP

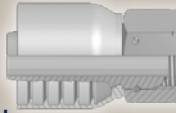
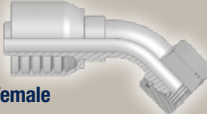
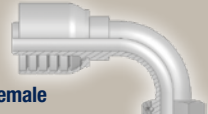
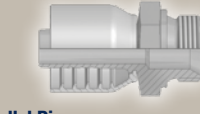
Page Cb-5 – Cb-8

<p>92 Cb-5 Female BSP Parallel Pipe Swivel – Straight (60° Cone) BS5200-A – DKR</p> 	<p>B1 Cb-5 Female BSP Parallel Pipe Swivel 45° Elbow (60° Cone) BS 5200-D – DKR 45°</p> 	<p>B2 Cb-6 Female BSP Parallel Pipe Swivel 90° Elbow (60° Cone) BS 5200-B – DKR 90°</p> 	<p>EA Cb-6 BSP Swivel Female with O-Ring (60° Cone) BS 5200 – ISO 12151-6 – DKOR</p> 
<p>EB Cb-7 BSP Swivel Female with O-Ring 45° Elbow (60° Cone) BS 5200 – ISO 12151-6 – DKOR 45°</p> 	<p>EC Cb-7 BSP Swivel Female with O-Ring 90° Elbow (60° Cone) BS 5200 – ISO 12151-6 – DKOR 90°</p> 	<p>D9 Cb-8 Male BSP Parallel Pipe Rigid – Straight (60° Cone) BS5200 – AGR</p> 	

SAE

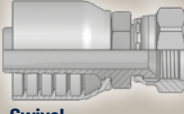
Page Cb-9 – Cb-10

<p>03 Cb-9 Male JIC 37° – Rigid Straight ISO12151-5-S – AGJ</p> 	<p>06 Cb-9 Female JIC 37° – Swivel Straight ISO12151-5-SWS – DKJ</p> 	<p>37 Cb-10 Female JIC 37° – Swivel 45° Elbow ISO 12151-5-SWE 45° – DKJ 45°</p> 	<p>39 Cb-10 Female JIC 37° – Swivel 90° Elbow ISO 12151-5-SWES – DKJ 90°</p> 
--	---	---	---

Flange

Page Cb-11 – Cb-13

15

Cb-11

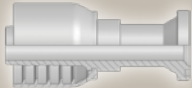

**ISO 6162-1-Flange
Straight**
ISO 12151-3-S-L – SFL
(21.0 MPa/ 3000 psi)

17

Cb-11

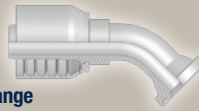

**ISO 6162-1 Flange
45° Elbow**
ISO 12151-3 – E45 – L – SFL 45°
(21.0 MPa/ 3000 psi)

19

Cb-12



**ISO 6162-1-Flange
90° Elbow**
ISO 12151-3 – E – L – SFL 90°
(21.0 MPa/ 3000 psi)

6A

Cb-12

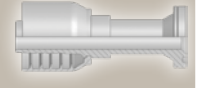

**ISO 6162-2-Flange
Straight**
ISO 12151-3-S-S – SFS
(42.0 MPa/ 6000 psi)

6N

Cb-13

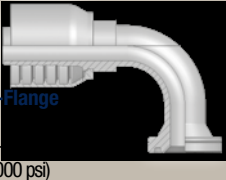

**ISO 6162-2-Flange
90° Elbow**
ISO 12151-3-S-S – SFS
(42.0 MPa/ 6000 psi)

ORFS

Page Cb-14 – Cb-15

JC

Cb-14

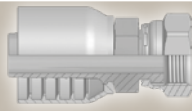

**Female ORFS
Swivel – Straight
Short**
ISO 12151-1 – SWSA SAE J516 – ORFS

JS

Cb-14

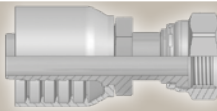

ORFS Swivel Female (Long)
ISO 12151-1-SWSB
SAE J516 – ORFS

J7

Cb-15

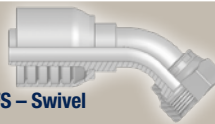

**Female ORFS – Swivel
45° Elbow**
ISO 12151-1 – SWE 45°
SAE J516 – ORFS 45°

J9

Cb-15



**Female ORFS – Swivel
90° Elbow – Short Drop**
ISO 12151-1 – SWES
SAE J516 – ORFS 90°

CA **Female Metric 24°
Light Series with O-Ring
Swivel – Straight**
ISO 12151-2-SWS-L – DKOL

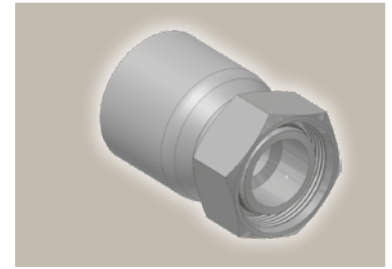
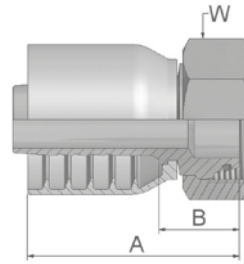

Part Number	Hose I.D.				Thread metric	Tube O.D. mm	A mm	B mm	W mm
	DN	Inch	Size	mm					
1CA43-10-6	10	3/8	-6	9.5	M16x1.5	10	54	25	19
1CA43-12-6	10	3/8	-6	9.5	M18x1.5	12	49	20	22
1CA43-15-8	12	1/2	-8	12.7	M22x1.5	15	57	22	27
1CA43-18-10	16	5/8	-10	15.9	M26x1.5	18	61	22	32
1CA43-22-10	16	5/8	-10	15.9	M30x2	22	64	24	36
1CA43-18-12	19	3/4	-12	19.1	M26x1.5	18	65	26	32
1CA43-22-12	19	3/4	-12	19.1	M30x2	22	63	24	36
1CA43-28-16	25	1	-16	25.4	M36x2	28	78	33	41
1CA43-35-16	25	1	-16	25.4	M45x2	35	76	31	50

Hose fittings are delivered with ozone resistant Nitrile (NBR) O-ring as a standard version. Working temperature from -40 °C up to +105 °C.
Hose fittings with special O-rings (Viton or EPDM) available on request. O-ring dimensions and part-numbers see in section Eb.

CE **Female Metric 24°
Light Series with O-Ring
Swivel – 45° Elbow**
ISO 12151-2-SWE -L – DKOL 45°

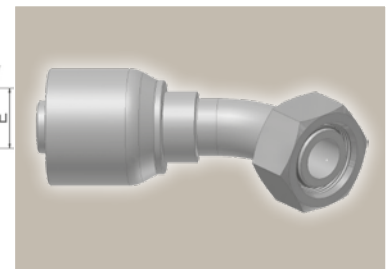
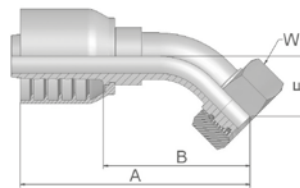

Part Number	Hose I.D.				Thread metric	Tube O.D. mm	A mm	B mm	E mm	W mm
	DN	Inch	Size	mm						
1CE43-12-6	10	3/8	-6	9.5	M18x1.5	12	69	40	20	22
1CE43-15-8	12	1/2	-8	12.7	M22x1.5	15	82	48	23	27
1CE43-18-10	16	5/8	-10	15.9	M26x1.5	18	89	49	23	32
1CE43-22-12	19	3/4	-12	19.1	M30x2	22	98	58	26	36
1CE43-28-16	25	1	-16	25.4	M36x2	28	127	80	34	41

Hose fittings are delivered with ozone resistant Nitrile (NBR) O-ring as a standard version. Working temperature from -40 °C up to +105 °C.
Hose fittings with special O-rings (Viton or EPDM) available on request. O-ring dimensions and part-numbers see in section Eb.

Approved **fitting series** for **hose types**, depending on size: Also available in stainless steel. Details can be found in CAT 4400.1/UK

43	304	387	387ST	387TC	421WC	426	487	487ST	487TC	722	722TC	722ST	...
	787	787TC	787ST	797	797TC	797ST	881						

CF **Female Metric 24°
Light Series with O-Ring
Swivel – 90° Elbow**

ISO 12151-2-SWE-L – DKOL 90°

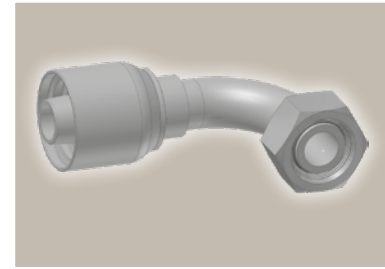
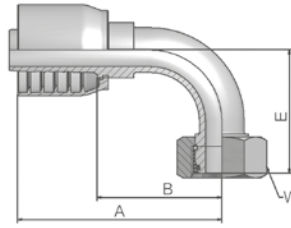

Part Number	Hose I.D.				Thread metric	Tube O.D. mm	A mm	B mm	E mm	W mm
	DN	Inch	Size	mm						
1CF43-12-6	10	3/8	-6	9.5	M18x1.5	12	64	35	36	22
1CF43-15-8	12	1/2	-8	12.7	M22x1.5	15	71	37	44	27
1CF43-18-10	16	5/8	-10	15.9	M26x1.5	18	81	41	45	32
1CF43-22-12	19	3/4	-12	19.1	M30x2	22	89	49	55	36
1CF43-28-16	25	1	-16	25.4	M36x2	28	114	68	78	41

Hose fittings are delivered with ozone resistant Nitrile (NBR) O-ring as a standard version. Working temperature from -40 °C up to +105 °C.
Hose fittings with special O-rings (Viton or EPDM) available on request. O-ring dimensions and part-numbers see in section Eb.

DO **Male Metric 24°
Light Series – Rigid
Straight**

ISO 12151-2-S-L – CEL

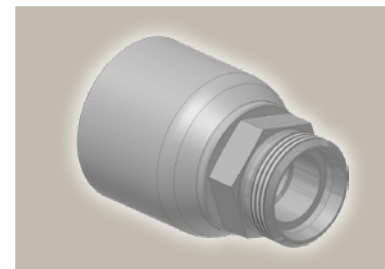
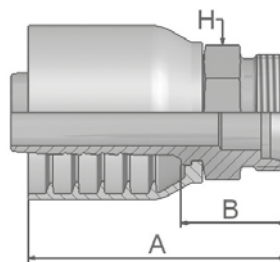

Part Number	Hose I.D.				Thread metric	Tube O.D. mm	A mm	B mm	H mm
	DN	Inch	Size	mm					
1D043-15-8	12	1/2	-8	12.7	M22x1.5	15	60	26	22
1D043-28-16	25	1	-16	25.4	M36x2	28	79	32	36

Approved **fitting series** for **hose types**, depending on size: Also available in stainless steel. Details can be found in CAT 4400.1/UK

43	304	387	387ST	387TC	421WC	426	487	487ST	487TC	722	722TC	722ST	...
	787	787TC	787ST	797	797TC	797ST	881						

C9 Female Metric 24° – Swivel Heavy Series with O-Ring Straight

ISO 12151-2-SWS-S – DKOS

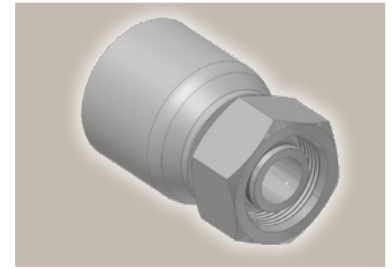
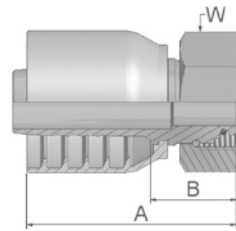

Part Number	Hose I.D.				Thread metric	Tube O.D. mm	A mm	B mm	W mm
	DN	Inch	Size	mm					
1C943-10-6	10	3/8	-6	9.5	M18x1.5	10	50	21	22
1C943-12-6	10	3/8	-6	9.5	M20x1.5	12	52	22	24
1C943-14-6	10	3/8	-6	9.5	M22x1.5	14	50	21	27
1C943-12-8	12	1/2	-8	12.7	M20x1.5	12	60	25	24
1C943-16-8	12	1/2	-8	12.7	M24x1.5	16	59	24	30
1C943-16-10	16	5/8	-10	15.9	M24x1.5	16	66	27	30
1C943-20-10	16	5/8	-10	15.9	M30x2	20	66	27	36
1C943-20-12	19	3/4	-12	19.1	M30x2	20	66	27	36
1C943-25-12	19	3/4	-12	19.1	M36x2	25	68	28	46
1C943-25-16	25	1	-16	25.4	M36x2	25	78	33	46
1C943-30-16	25	1	-16	25.4	M42x2	30	80	33	50

Hose fittings are delivered with ozone resistant Nitrile (NBR) O-ring as a standard version. Working temperature from -40 °C up to +105 °C. Hose fittings with special O-rings (Viton or EPDM) available on request. O-ring dimensions and part-numbers see in section Eb.

OC Female Metric 24° – Swivel Heavy Series with O-Ring 45° Elbow

ISO 12151-2 – SWE -S – DKOS 45°

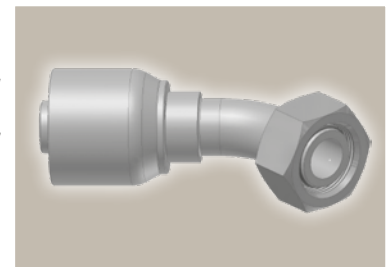
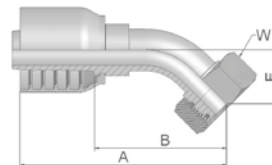

Part Number	Hose I.D.				Thread metric	Tube O.D. mm	A mm	B mm	E mm	W mm
	DN	Inch	Size	mm						
10C43-12-6	10	3/8	-6	9.5	M20x1.5	12	69	40	20	24
10C43-14-6	10	3/8	-6	9.5	M22x1.5	14	76	46	20	27
10C43-16-8	12	1/2	-8	12.7	M24x1.5	16	82	48	24	30
10C43-20-10	16	5/8	-10	15.9	M30x2	20	91	51	25	36
10C43-20-12	19	3/4	-12	19.1	M30x2	20	99	60	28	36
10C43-25-12	19	3/4	-12	19.1	M36x2	25	100	61	29	46
10C43-25-16	25	1	-16	25.4	M36x2	30	123	76	33	46
10C43-30-16	25	1	-16	25.4	M42x2	30	126	79	36	50

Hose fittings are delivered with ozone resistant Nitrile (NBR) O-ring as a standard version. Working temperature from -40 °C up to +105 °C. Hose fittings with special O-rings (Viton or EPDM) available on request. O-ring dimensions and part-numbers see in section Eb.

Approved **fitting series** for hose types, depending on size: Also available in stainless steel. Details can be found in CAT 4400.1/UK

43	304	387	387ST	387TC	421WC	426	487	487ST	487TC	722	722TC	722ST	...
	787	787TC	787ST	797	797TC	797ST	881						

1C Female Metric 24° – Swivel Heavy Series with O-Ring 90° Elbow

ISO 12151-2-SWE-S – DKOS 90°

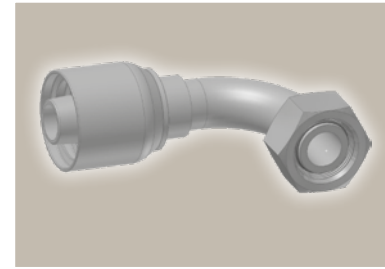
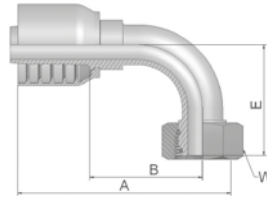

Part Number	Hose I.D.				Thread metric	Tube O.D. mm	A mm	B mm	E mm	W mm
	DN	Inch	Size	mm						
11C43-8-6	10	3/8	-6	9.5	M16x1.5	8	67	38	37	19
11C43-12-6	10	3/8	-6	9.5	M20x1.5	12	65	35	37	24
11C43-14-6	10	3/8	-6	9.5	M22x1.5	14	64	35	37	27
11C43-16-8	12	1/2	-8	12.7	M24x1.5	16	72	37	45	30
11C43-20-10	16	5/8	-10	15.9	M30x2	20	79	40	48	36
11C43-25-10	16	5/8	-10	15.9	M36x2	25	85	45	52	46
11C43-20-12	19	3/4	-12	19.1	M30x2	20	89	50	58	36
11C43-25-12	19	3/4	-12	19.1	M36x2	25	89	49	59	46
11C43-25-16	25	1	-16	25.4	M36x2	25	109	64	69	46
11C43-30-16	25	1	-16	25.4	M42x2	30	115	68	76	50

Hose fittings are delivered with ozone resistant Nitrile (NBR) O-ring as a standard version. Working temperature from -40 °C up to +105 °C. Hose fittings with special O-rings (Viton or EPDM) available on request. O-ring dimensions and part-numbers see in section Eb.

D2 Male Metric 24° – Rigid Heavy Series – Straight

ISO 12151-2-S-S – CES

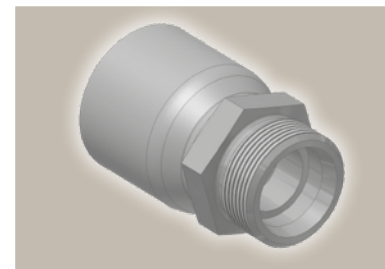
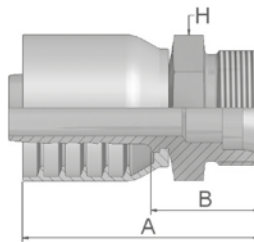

Part Number	Hose I.D.				Thread metric	Tube O.D. mm	A mm	B mm	H mm
	DN	Inch	Size	mm					
1D243-12-6	10	3/8	-6	9.5	M20x1.5	12	55	26	22
1D243-14-6	10	3/8	-6	9.5	M22x1.5	14	55	25	22
1D243-16-8	12	1/2	-8	12.7	M24x1.5	16	62	28	24
1D243-20-10	16	5/8	-10	15.9	M30x2	20	72	33	30
1D243-20-12	19	3/4	-12	19.1	M30x2	20	72	33	30
1D243-25-12	19	3/4	-12	19.1	M36x2	25	74	35	36
1D243-30-16	25	1	-16	25.4	M42x2	30	85	40	46

Approved **fitting series** for hose types, depending on size: Also available in stainless steel. Details can be found in CAT 4400.1/UK

43	304	387	387ST	387TC	421WC	426	487	487ST	487TC	722	722TC	722ST	...
	787	787TC	787ST	797	797TC	797ST	881						

92 Female BSP Parallel Pipe Swivel – Straight (60° Cone)

BS5200-A – DKR

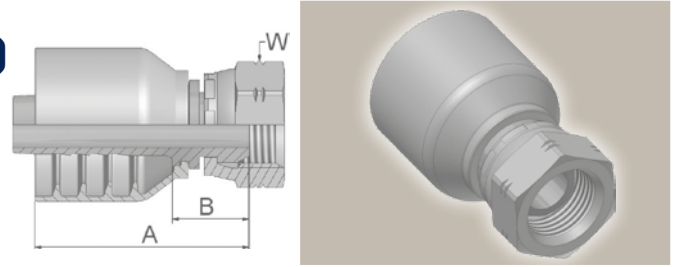

Part Number	Hose I.D.				Thread BSP	A mm	B mm	W mm
	DN	Inch	Size	mm				
19243-6-6	10	3/8	-6	9.5	3/8x19	49	20	22
19243-8-6	10	3/8	-6	9.5	1/2x14	51	22	27
19243-8-8	12	1/2	-8	12.7	1/2x14	57	22	27
19243-10-8	12	1/2	-8	12.7	5/8x14	55	20	30
19243-10-10	16	5/8	-10	15.9	5/8x14	57	21	30
19243-12-10	16	5/8	-10	15.9	3/4x14	61	22	32
19243-12-12	19	3/4	-12	19.1	3/4x14	61	22	32
19243-16-16	25	1	-16	25.4	1x11	72	25	41

B1 Female BSP Parallel Pipe Swivel 45° Elbow (60° Cone)

BS 5200-D – DKR 45°

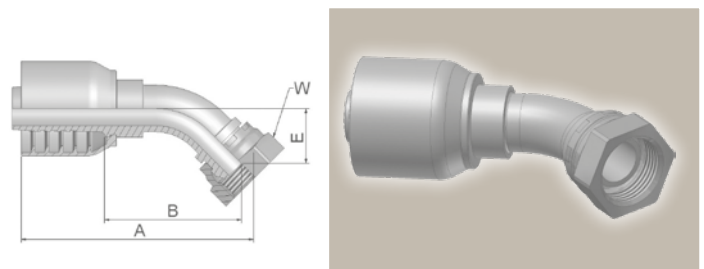

Part Number	Hose I.D.				Thread BSP	A mm	B mm	E mm	W mm
	DN	Inch	Size	mm					
1B143-6-6	10	3/8	-6	9.5	3/8x19	67	37	17	22
1B143-8-8	12	1/2	-8	12.7	1/2x14	79	45	20	27
1B143-10-10	16	5/8	-10	15.9	5/8x14	89	50	23	30
1B143-12-12	19	3/4	-12	19.1	3/4x14	96	57	25	32
1B143-16-16	25	1	-16	25.4	1x11	121	77	33	41

Approved **fitting series** for hose types, depending on size: Also available in stainless steel. Details can be found in CAT 4400.1/UK

43	304	387	387ST	387TC	421WC	426	487	487ST	487TC	722	722TC	722ST	...
	787	787TC	787ST	797	797TC	797ST	881						

B2 Female BSP Parallel Pipe Swivel 90° Elbow (60° Cone)

BS 5200-B – DKR 90°

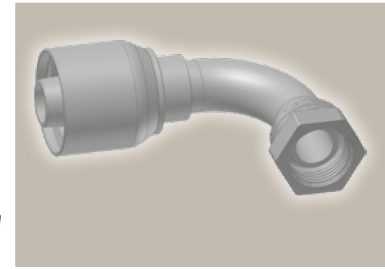
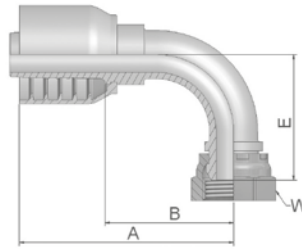

Part Number	Hose I.D.				Thread BSP	A mm	B mm	E mm	W mm
	DN	Inch	Size	mm					
1B243-6-6	10	3/8	-6	9.5	3/8x19	66	37	33	22
1B243-8-6	10	3/8	-6	9.5	1/2x14	66	37	35	27
1B243-8-8	12	1/2	-8	12.7	1/2x14	74	39	40	27
1B243-10-10	16	5/8	-10	15.9	5/8x14	81	41	46	30
1B243-12-10	16	5/8	-10	15.9	3/4x14	82	43	45	32
1B243-12-12	19	3/4	-12	19.1	3/4x14	89	50	53	32
1B243-16-16	25	1	-16	25.4	1x11	116	69	69	41

EA BSP Swivel Female with O-Ring (60° Cone)

BS 5200 – ISO 12151-6 – DKOR

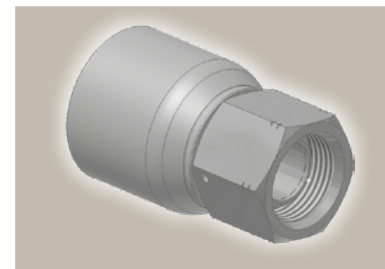
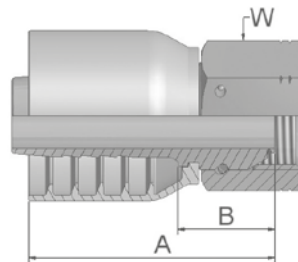

Part Number	Hose I.D.				Thread BSP	A mm	B mm	W mm
	DN	Inch	Size	mm				
1EA43-8-8	12	1/2	-8	12.7	1/2x14	56	21	27
1EA43-10-10	16	5/8	-10	15.9	5/8x14	61	21.5	30
1EA43-12-12	19	3/4	-12	19.1	3/4x14	63	23	32
1EA43-16-16	25	1	-16	25.4	1x11	77	31	41

Hose fittings are delivered with ozone resistant Nitrile (NBR) O-ring as a standard version. Working temperature from -40 °C up to +105 °C.
Hose fittings with special O-rings (Viton or EPDM) available on request. O-ring dimensions and part-numbers see in section Eb.

Approved **fitting series** for **hose types**, depending on size: Also available in stainless steel. Details can be found in CAT 4400.1/UK

43	304	387	387ST	387TC	421WC	426	487	487ST	487TC	722	722TC	722ST	...
	787	787TC	787ST	797	797TC	797ST	881						

EB BSP Swivel Female with O-Ring 45° Elbow (60° Cone)

BS 5200 – ISO 12151-6 – DKOR 45°

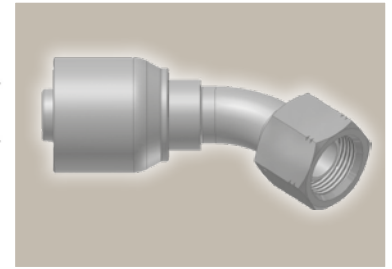
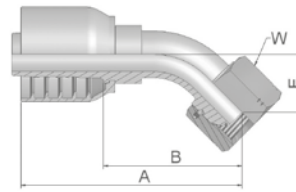

Part Number	Hose I.D.				Thread BSP	A mm	B mm	E mm	W mm
	DN	Inch	Size	mm					
1EB43-4-4	6	1/4	-4	6.4	1/4x19	57	34	14	19
1EB43-6-6	10	3/8	-6	9.5	3/8x19	73	44	18	22
1EB43-8-8	12	1/2	-8	12.7	1/2x14	79	44	20	27
1EB43-10-10	16	5/8	-10	15.9	5/8	85	49	22	30

Hose fittings are delivered with ozone resistant Nitrile (NBR) O-ring as a standard version. Working temperature from -40 °C up to +105 °C.
Hose fittings with special O-rings (Viton or EPDM) available on request. O-ring dimensions and part-numbers see in section Eb.

EC BSP Swivel Female with O-Ring 90° Elbow (60° Cone)

BS 5200 – ISO 12151-6 – DKOR 90°

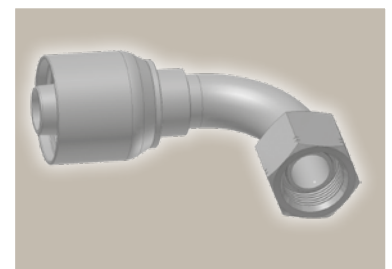
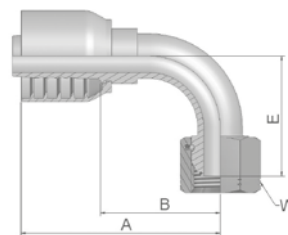

Part Number	Hose I.D.				Thread BSP	A mm	B mm	E mm	W mm
	DN	Inch	Size	mm					
1EC43-4-4	6	1/4	-4	6.4	1/4x19	50	27	24	19
1EC43-6-4	6	1/4	-4	6.4	3/8x19	51	28	27	22
1EC43-6-6	10	3/8	-6	9.5	3/8x19	64	35	34	22
1EC43-8-8	12	1/2	-8	12.7	1/2x14	71	36	40	27
1EC43-10-10	16	5/8	-10	15.9	5/8	80	43	44	30
1EC43-12-12	19	3/4	-12	19.1	3/4x14	89	49	55	32
1EC43-16-16	25	1	-16	25.4	1x11	115	68	71	41

Hose fittings are delivered with ozone resistant Nitrile (NBR) O-ring as a standard version. Working temperature from -40 °C up to +105 °C.
Hose fittings with special O-rings (Viton or EPDM) available on request. O-ring dimensions and part-numbers see in section Eb.

Approved **fitting series** for hose types, depending on size: Also available in stainless steel. Details can be found in CAT 4400.1/UK

43	304	387	387ST	387TC	421WC	426	487	487ST	487TC	722	722TC	722ST	...
	787	787TC	787ST	797	797TC	797ST	881						

D9 **Male BSP Parallel Pipe
Rigid – Straight (60° Cone)**
BS5200 – AGR

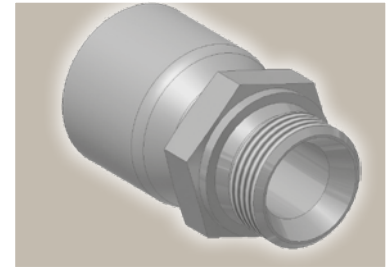
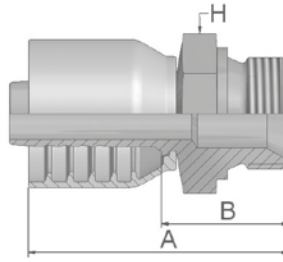

Part Number	Hose I.D.				Thread BSP	A mm	B mm	H mm
	DN	Inch	Size	mm				
1D943-2-4	6	1/4	-4	6.4	1/8x28	46	22	14
1D943-4-4	6	1/4	-4	6.4	1/4x19	49	27	19
1D943-6-6	10	3/8	-6	9.5	3/8x19	57	28	22
1D943-8-6	10	3/8	-6	9.5	1/2x14	60	31	27
1D943-8-8	12	1/2	-8	12.7	1/2x14	64	30	27
1D943-10-10	16	5/8	-10	15.9	5/8x14	75	36	30
1D943-12-10	16	5/8	-10	15.9	3/4x14	72	35	32
1D943-12-12	19	3/4	-12	19.1	3/4x14	72	33	32
1D943-16-12	19	3/4	-12	19.1	1x11	77	38	41
1D943-16-16	25	1	-16	25.4	1x11	85	40	41

Approved **fitting series** for **hose types**, depending on size: Also available in stainless steel. Details can be found in CAT 4400.1/UK

43	304	387	387ST	387TC	421WC	426	487	487ST	487TC	722	722TC	722ST	...
	787	787TC	787ST	797	797TC	797ST	881						

03 Male JIC 37° – Rigid Straight

ISO12151-5-S – AGJ

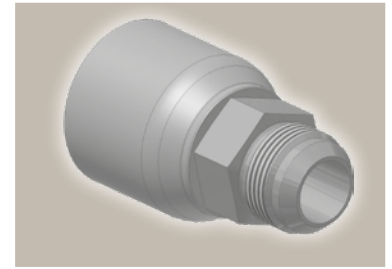
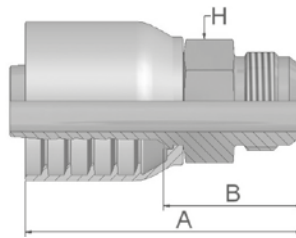

Part Number	Hose I.D.				Thread UNF	A mm	B mm	H mm
	DN	Inch	Size	mm				
10343-6-6	10	3/8	-6	9.5	9/16x18	57	31	3/4
10343-8-6	10	3/8	-6	9.5	3/4x16	58	32	7/8

06 Female JIC 37° – Swivel Straight

ISO12151-5-SWS – DKJ

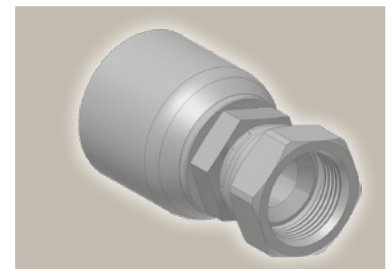
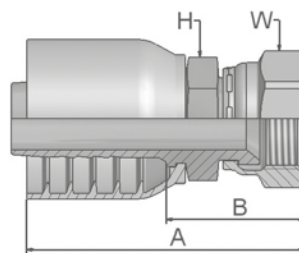

Part Number	Hose I.D.				Thread UNF	A mm	B mm	H		W	
	DN	Inch	Size	mm				mm	Inch	mm	Inch
10643-6-6	10	3/8	-6	9.5	9/16x18	58	32	11/16	11/16		
10643-8-6	10	3/8	-6	9.5	3/4x16	63	37	11/16	7/8		
10643-8-8*	12	1/2	-8	12.7	3/4x16	66	34	13/16	7/8		
10643-10-8	12	1/2	-8	12.7	7/8x14	72	40	7/8	1		
10643-10-10*	16	5/8	-10	15.9	7/8x14	73	38	15/16	1		
10643-12-10	16	5/8	-10	15.9	1 1/16x12	79	42	1 1/16	1 1/4		
10643-12-12	19	3/4	-12	19.1	1 1/16x12	81	44	1 1/16	1 1/4		
10643-14-12	19	3/4	-12	19.1	1 3/16x12	81	44	1 1/4	1 3/8		
10643-12-16	25	1	-16	25.4	1 1/16x12	84	42	1 3/8	1 1/4		
10643-16-16	25	1	-16	25.4	1 5/16x12	92	51	1 3/8	1 1/2		

* These fittings contain a dual seat that accepts both JIC (37°) and SAE (45°) male configurations.

Approved **fitting series** for hose types, depending on size: Also available in stainless steel. Details can be found in CAT 4400.1/UK

43	304	387	387ST	387TC	421WC	426	487	487ST	487TC	722	722TC	722ST	...
	787	787TC	787ST	797	797TC	797ST	881						

37 Female JIC 37° – Swivel 45° Elbow

ISO 12151-5-SWE 45° – DKJ 45°

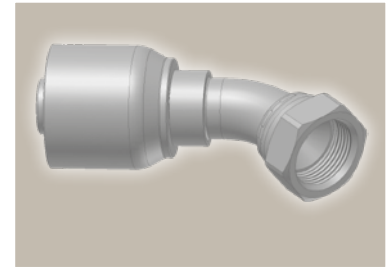
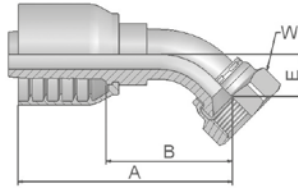

Part Number	Hose I.D.				Thread UNF	A mm	B mm	E mm	W mm
	DN	Inch	Size	mm					
13743-6-6	10	3/8	-6	9.5	9/16x18	61	35	10	11/16
13743-8-8	12	1/2	-8	12.7	3/4x16	72	40	14	7/8
13743-12-12	19	3/4	-12	19.1	1 1/16x12	92	56	20	1 1/4
13743-16-12	19	3/4	-12	19.1	1 5/16x12	95	56	24	38
13743-16-16	25	1	-16	25.4	1 5/16x12	110	69	24	1 1/2

* These fittings contain a dual seat that accepts both JIC (37°) and SAE (45°) male configurations.

39 Female JIC 37° – Swivel 90° Elbow

ISO 12151-5-SWES – DKJ 90°

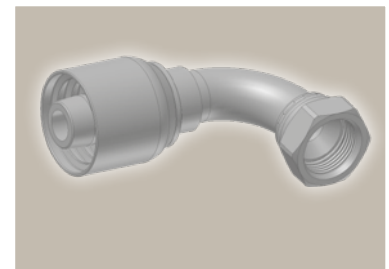
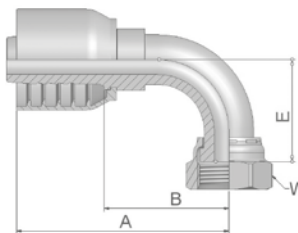

Part Number	Hose I.D.				Thread UNF	A mm	B mm	E mm	W	
	DN	Inch	Size	mm					mm	Inch
13943-6-6	10	3/8	-6	9.5	9/16x18	56	30	23	11/16	
13943-10-8	12	1/2	-8	12.7	7/8x14	70	38	32	1	
13943-10-10*	16	5/8	-10	15.9	7/8x14	80	40	37	1	
13943-12-12	19	3/4	-12	19.1	1 1/16x12	89	52	48	1 1/4	
13943-16-16	25	1	-16	25.4	1 5/16x12	109	68	56	1 1/2	

* These fittings contain a dual seat that accepts both JIC (37°) and SAE (45°) male configurations.

Approved **fitting series** for **hose types**, depending on size: Also available in stainless steel. Details can be found in CAT 4400.1/UK

43	304	387	387ST	387TC	421WC	426	487	487ST	487TC	722	722TC	722ST	...
	787	787TC	787ST	797	797TC	797ST	881						

15 ISO 6162-1-Flange Straight

ISO 12151-3-S-L – SFL
(21.0 MPa/ 3000 psi)

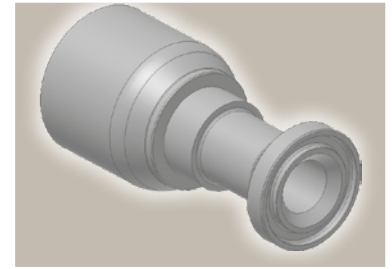
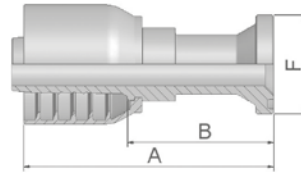

Part Number	Hose I.D.				Flange Inch	A mm	B mm	F mm
	DN	Inch	Size	mm				
11543-8-8	12	1/2	-8	12.7	1/2	89	54	30
11543-12-10	16	5/8	-10	15.9	3/4	69	30	38
11543-12-12	19	3/4	-12	19.1	3/4	98	59	38
11543-16-12	19	3/4	-12	19.1	1	70	31	45
11543-16-16	25	1	-16	25.4	1	108	63	45
11543-20-16	25	1	-16	25.4	1 1/4	82	36	51

To select corresponding half-flange and O-ring see section Eb.

17 ISO 6162-1 Flange 45° Elbow

ISO 12151-3 – E45 – L – SFL 45°
(21.0 MPa/ 3000 psi)

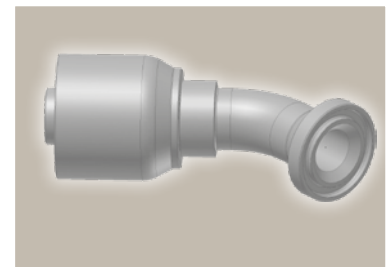
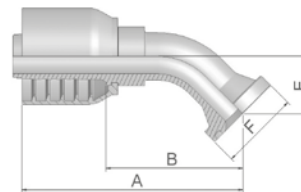

Part Number	Hose I.D.				Flange Inch	A mm	B mm	E mm	F mm
	DN	Inch	Size	mm					
11743-8-8	12	1/2	-8	12.7	1/2	79	44	20	30
11743-12-10	16	5/8	-10	15.9	3/4	96	57	26	38
11743-12-12	19	3/4	-12	19.1	3/4	98	58	26	38
11743-16-16	25	1	-16	25.4	1	119	73	27	45
11743-20-16	25	1	-16	25.4	1 1/4	121	76	32	51

To select corresponding half-flange and O-ring see section Eb.

Approved **fitting series** for hose types, depending on size: Also available in stainless steel. Details can be found in CAT 4400.1/UK

43	304	387	387ST	387TC	421WC	426	487	487ST	487TC	722	722TC	722ST	...
	787	787TC	787ST	797	797TC	797ST	881						

19 ISO 6162-1-Flange 90° Elbow

ISO 12151-3 – E– L – SFL 90°
(21.0 MPa/ 3000 psi)

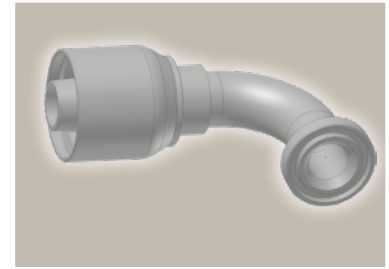
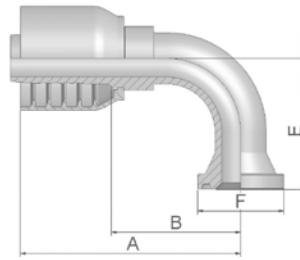

Part Number	Hose I.D.				Flange Inch	A mm	B mm	E mm	F mm
	DN	Inch	Size	mm					
11943-8-8	12	1/2	-8	12.7	1/2	75	40	41	30
11943-12-12	19	3/4	-12	19.1	3/4	89	50	58	38
11943-16-12	19	3/4	-12	19.1	1	90	50	58	45

To select corresponding half-flange and O-ring see section Eb.

6A ISO 6162-2-Flange Straight

ISO 12151-3-S-S – SFS
(42.0 MPa/ 6000 psi)

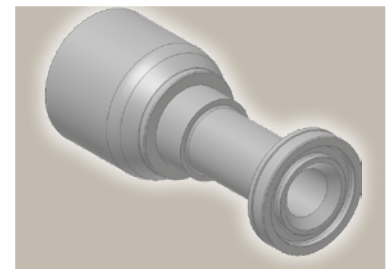
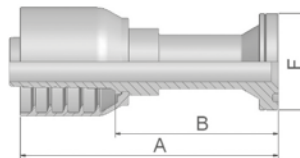

Part Number	Hose I.D.				Flange Inch	A mm	B mm	F mm
	DN	Inch	Size	mm				
16A43-12-12	19	3/4	-12	19.1	3/4	105	66	41
16A43-16-16	25	1	-16	25.4	1	127	82	48

To select corresponding half-flange and O-ring see section Eb.

Approved **fitting series** for **hose types**, depending on size: Also available in stainless steel. Details can be found in CAT 4400.1/UK

43	304	387	387ST	387TC	421WC	426	487	487ST	487TC	722	722TC	722ST	...
	787	787TC	787ST	797	797TC	797ST	881						

6N

ISO 6162-2-Flange 90° Elbow

ISO 12151-3 – E-S – SFS 90°
(42.0 MPa/ 6000 psi)

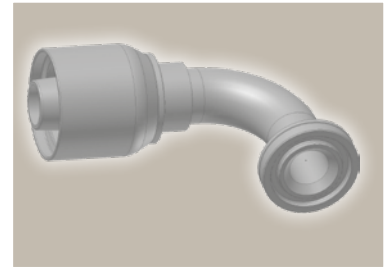
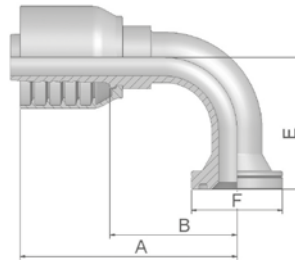

Part Number	Hose I.D.				Flange Inch	A mm	B mm	E mm	F mm
	DN	Inch	Size	mm					
16N43-12-12	19	3/4	-12	19.1	3/4	98	58	54	41
16N43-16-16	25	1	-16	25.4	1	111	64	70	48

To select corresponding half-flange and O-ring see section Eb.

Approved **fitting series** for hose types, depending on size: Also available in stainless steel. Details can be found in CAT 4400.1/UK

43	304	387	387ST	387TC	421WC	426	487	487ST	487TC	722	722TC	722ST	...
	787	787TC	787ST	797	797TC	797ST	881						

JC Female ORFS Swivel – Straight Short

ISO 12151-1 – SWSA
SAE J516 – ORFS

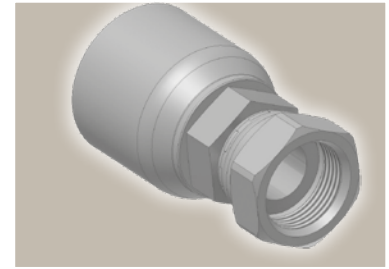
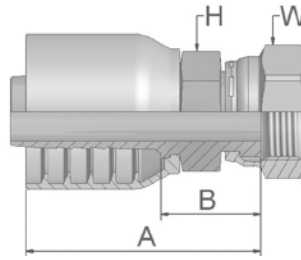

Part Number	Hose I.D.				Thread UNF	A mm	B mm	H mm	W mm
	DN	Inch	Size	mm					
1JC43-6-6	10	3/8	-6	9.5	11/16x16	49	23	11/16	13/16
1JC43-8-8	12	1/2	-8	12.7	13/16x16	56	24	13/16	15/16
1JC43-10-8	12	1/2	-8	12.7	1x14	58	26	15/16	1-1/8
1JC43-10-10	16	5/8	-10	15.9	1x14	63	27	15/16	1-1/8
1JC43-12-12	19	3/4	-12	19.1	1 3/16x12	68	31	1 1/8	1 3/8
1JC43-16-12	19	3/4	-12	19.1	1 7/16x12	72	35	1 3/8	1 5/8
1JC43-16-16	25	1	-16	25.4	1 7/16x12	80	39	1 3/8	1 5/8

JS ORFS Swivel Female (Long)

ISO 12151-1-SWSB
SAE J516 – ORFS

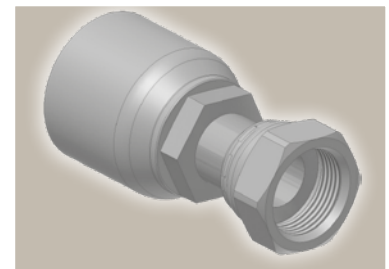
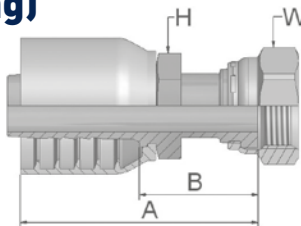

Part Number	Hose I.D.				Thread UNF	A mm	B mm	H mm Inch	W mm Inch
	DN	Inch	Size	mm					
1JS43-10-10	16	5/8	-10	15.9	1x14	78	42	15/16	1 1/8

Approved **fitting series** for **hose types**, depending on size: Also available in stainless steel. Details can be found in CAT 4400.1/UK

43	304	387	387ST	387TC	421WC	426	487	487ST	487TC	722	722TC	722ST	...
	787	787TC	787ST	797	797TC	797ST	881						

J7

Female ORFS – Swivel 45° Elbow

ISO 12151-1 – SWE 45°
SAE J516 – ORFS 45°

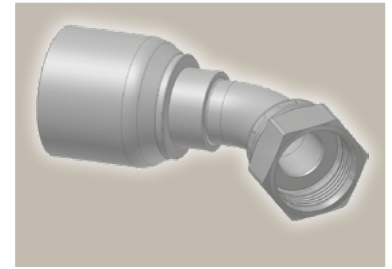
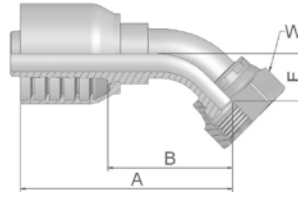

Part Number	Hose I.D.				Thread UNF	A mm	B mm	E mm	W mm
	DN	Inch	Size	mm					
1J743-8-6	10	3/8	-6	9.5	13/16x16	64	38	15	15/16
1J743-8-8	12	1/2	-8	12.7	13/16x16	72	40	15	15/16
1J743-10-10	16	5/8	-10	15.9	1x14	81	44	16	1 1/8
1J743-12-12	19	3/4	-12	19.1	1 3/16x12	92	56	21	1 3/8
1J743-16-16	25	1	-16	25.4	1 7/16x12	111	70	24	1 5/8

J9

Female ORFS – Swivel 90° Elbow – Short Drop

ISO 12151-1 – SWES
SAE J516 – ORFS 90°

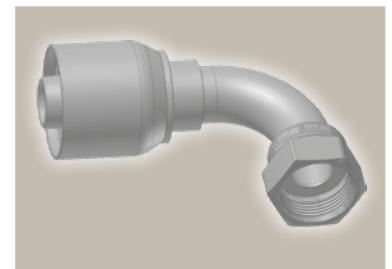
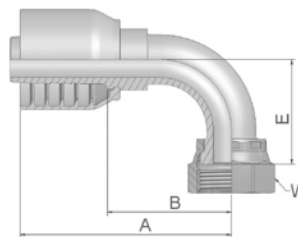

Part Number	Hose I.D.				Thread UNF	A mm	B mm	E mm	W mm
	DN	Inch	Size	mm					
1J943-6-6	10	3/8	-6	9.5	11/16x16	56	30	23	13/16
1J943-8-6	10	3/8	-6	9.5	13/16x16	58	32	29	15/16
1J943-8-8	12	1/2	-8	12.7	13/16x16	66	34	29	15/16
1J943-10-8	12	1/2	-8	12.7	1x14	70	38	32	1 1/8
1J943-10-10	16	5/8	-10	15.9	1x14	75	39	32	1 1/8
1J943-12-10	16	5/8	-10	15.9	1 3/16x12	89	52	48	1 3/8
1J943-12-12	19	3/4	-12	19.1	1 3/16x12	78	52	48	1 3/8
1J943-16-16	25	1	-16	25.4	1 7/16x12	109	68	56	1 5/8

Approved **fitting series** for hose types, depending on size: Also available in stainless steel. Details can be found in CAT 4400.1/UK

43	304	387	387ST	387TC	421WC	426	487	487ST	487TC	722	722TC	722ST	...
	787	787TC	787ST	797	797TC	797ST	881						

DIN – Metric

Page Cc-1 – Cc-9

CA
Cc-1

Female Metric 24°
Light Series with O-Ring
Swivel – Straight
ISO 12151-2-SWS-L – DKOL

CE
Cc-2

Female Metric 24°
Light Series with O-Ring
Swivel – 45° Elbow
ISO 12151-2-SWE-L – DKOL 45°

CF
Cc-3

Female Metric 24°
Light Series with O-Ring
Swivel – 90° Elbow
ISO 12151-2-SWE-L – DKOL 90°

D0
Cc-4

Male Metric 24°
Light Series – Rigid
Straight
ISO 12151-2-S-L – CEL

C9
Cc-5

Female Metric 24° – Swivel
Heavy Series with O-Ring
Straight
ISO 12151-2-SWS-S – DKOS

0C
Cc-6

Female Metric 24° – Swivel
Heavy Series with O-Ring
45° Elbow
ISO 12151-2 – SWE-S – DKOS 45°

1C
Cc-7

Female Metric 24° – Swivel
Heavy Series with O-Ring
90° Elbow
ISO 12151-2-SWE-S – DKOS 90°

D2
Cc-8

Male Metric 24° – Rigid
Heavy Series – Straight
ISO 12151-2-S-S – CES

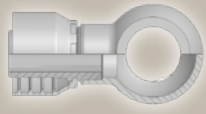
49
Cc-9

Metric Banjo
Straight
DIN 7642

BSP

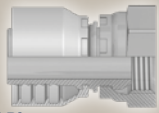
Page Cc-10 – Cc-18

92
Cc-10

Female BSP Parallel Pipe
Swivel – Straight (60° Cone)
BS5200-A – DKR

B1
Cc-11

Female BSP Parallel Pipe
Swivel
45° Elbow (60° Cone)
BS 5200-D – DKR 45°

B2
Cc-12

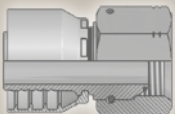
Female BSP Parallel Pipe
Swivel
90° Elbow (60° Cone)
BS 5200-B – DKR 90°

B4
Cc-13

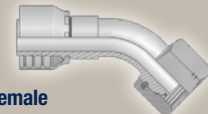
Female BSP Parallel Pipe
Swivel – 90° Elbow
Block Type (60° Cone)
BS 5200-E – DKR 90°

EA
Cc-14

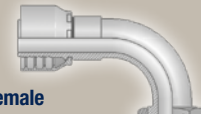
BSP Swivel Female
with O-Ring (60° Cone)
BS 5200 – ISO 12151-6 – DKOR

EB
Cc-15

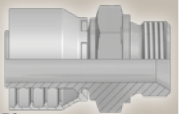
BSP Swivel Female
with O-Ring
45° Elbow (60° Cone)
BS 5200 – ISO 12151-6 – DKOR 45°

EC
Cc-16

BSP Swivel Female
with O-Ring
90° Elbow (60° Cone)
BS 5200 – ISO 12151-6 – DKOR 90°

D9
Cc-17

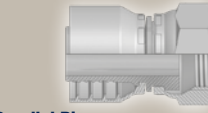
Male BSP Parallel Pipe
Rigid – Straight (60° Cone)
BS5200 – AGR



91
Cc-18

Male BSP Taper Pipe – Rigid
Straight
BS5200 – AGR-K

B5
Cc-18

Female BSP Parallel Pipe
Swivel
Straight (Flat Seat)

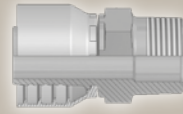
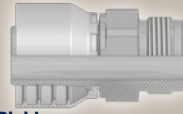
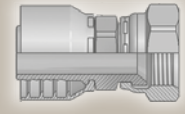
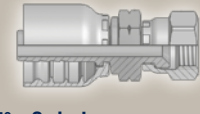
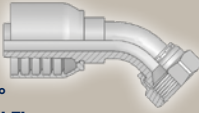
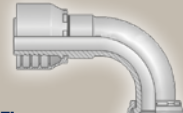

SAE

Page Cc-19 – Cc-24

<p>01 Cc-19</p>  <p>Male NPTF Pipe Rigid – Straight SAE J476A / J516 – AGN</p>	<p>03 Cc-20</p>  <p>Male JIC 37° – Rigid Straight ISO12151-5-S – AGJ</p>	<p>06/68 Cc-21</p>  <p>Female – JIC 37° SAE 45° Dual Flare Swivel – Straight ISO12151-5-SWS – DKJ</p>	<p>08 Cc-22</p>  <p>Female SAE 45° – Swivel Straight SAE J516</p>
<p>37/3V Cc-22</p>  <p>Female JIC 37° SAE 45° – Dual Flare Swivel Female 45° Elbow ISO 12151-5-SWE 45° – DKJ 45°</p>	<p>39/3W Cc-23</p>  <p>Female JIC 37° SAE 45° – Dual Flare Swivel Female 90° Elbow ISO 12151-5-SWES – DKJ 90°</p>	<p>41/3Y Cc-24</p>  <p>Female JIC 37° / 45° Swivel Female 90° Elbow (Long) ISO 12151-5-SWEL – DKJ 90°L</p>	

Flange

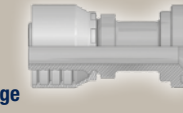
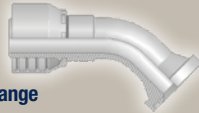
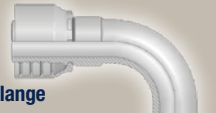
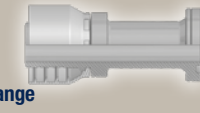
Page Cc-25 – Cc-29

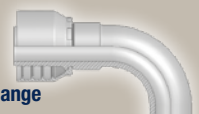
<p>15 Cc-25</p>  <p>ISO 6162-1-Flange Straight ISO 12151-3-S-L – SFL (21.0 MPa/ 3000 psi)</p>	<p>17 Cc-26</p>  <p>ISO 6162-1 Flange 45° Elbow ISO 12151-3 – E45 – L – SFL 45° (21.0 MPa/ 3000 psi)</p>	<p>19 Cc-27</p>  <p>ISO 6162-1-Flange 90° Elbow ISO 12151-3 – E – L – SFL 90° (21.0 MPa/ 3000 psi)</p>	<p>6A Cc-28</p>  <p>ISO 6162-2-Flange Straight ISO 12151-3-S-S – SFS (42.0 MPa/ 6000 psi)</p>
<p>6F Cc-28</p>  <p>ISO 6162-2-Flange 45° Elbow – Heavy Series ISO 12151-3 – E45-S – SFS 45° (42.0 MPa/ 6000 psi)</p>	<p>6N Cc-29</p>  <p>ISO 6162-2-Flange 90° Elbow ISO 12151-3 – E-S – SFS 90° (42.0 MPa/ 6000 psi)</p>		

ORFS

Page Cc-30 – Cc-35

<p>JC Cc-30</p>  <p>Female ORFS Swivel – Straight Short ISO 12151-1 – SWSA SAE J516 – ORFS</p>	<p>JS Cc-31</p>  <p>ORFS Swivel Female (Long) ISO 12151-1-SWSB SAE J516 – ORFS</p>	<p>J7 Cc-32</p>  <p>Female ORFS – Swivel 45° Elbow ISO 12151-1 – SWE 45° SAE J516 – ORFS 45°</p>	<p>J9 Cc-33</p>  <p>Female ORFS – Swivel 90° Elbow – Short Drop ISO 12151-1 – SWES SAE J516 – ORFS 90°</p>
<p>J1 Cc-34</p>  <p>Female ORFS – Swivel 90° Elbow – Long Drop ISO 12151-1 – SWEL SAE J516 – ORFS 90° L</p>	<p>J5 Cc-34</p>  <p>Female ORFS – Swivel 90° Elbow – Medium Drop ISO 12151-1 – SWEM – ORFS 90° M</p>	<p>JM Cc-35</p>  <p>ORFS Male ISO 12151-1-S – SAE J516</p>	<p>JD Cc-35</p>  <p>Male ORFS Bulkhead with Locknut Straight (with O-ring) ISO 12151-1 – SAE J516</p>

46/48 Series

JIS

Page Cc-36 – Cc-37

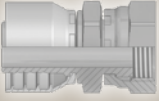
FU
Cc-36

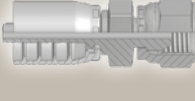
Female BSP Parallel Pipe Swivel – Straight (30° Flare)
ISO 228-1 – JIS B8363 – GU1

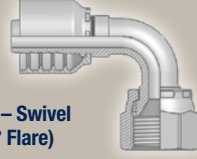
GU
Cc-36

Female BSP Parallel Pipe Swivel – Straight (60° Cone)
ISO 228-1 – JIS B8363 – GU0

MZ
Cc-37

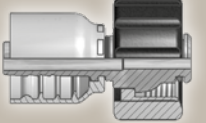
Female Metric – Swivel 90° Elbow (30° Flare)
JIS B8363

High Pressure Cleaning

Page Cc-38 – Cc-39

CW
Cc-38

Power Cleaner Connection

NW
Cc-38

Female Kärcher Metric Cleaning Hose Fitting Swivel – Straight

PW
Cc-39

Male Kärcher Metric Cleaning Hose Fitting Rigid – Straight

Others

Page Cc-40

XU
Cc-40

Female Metric – Swivel Straight (30° Flare)
JIS B8363

UPTC (Universal push-to-connect)

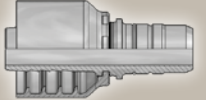
Page Cc-41 – Cc-42

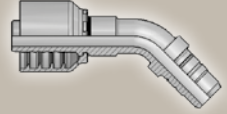
EN
Cc-41

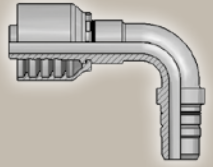
UPTC – Male Straight

EU
Cc-41

UPTC – Male 45° Elbow

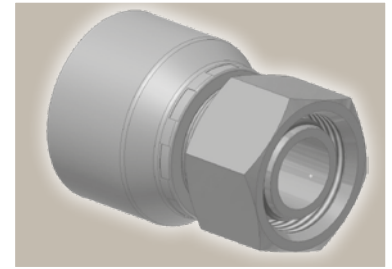
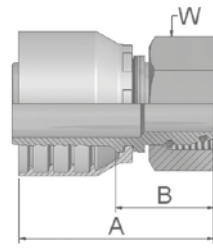
ET
Cc-42

UPTC – Male 90° Elbow

CA **Female Metric 24°
Light Series with O-Ring
Swivel – Straight**
ISO 12151-2-SWS-L – DKOL



Part Number		Hose I.D.				Thread	Tube O.D.	A	B	W
46 series	48 series	DN	Inch	Size	mm	metric	mm	mm	mm	mm
1CA46-6-4	1CA48-6-4	6	1/4	-4	6.4	M12x1.5	6	46	22	14
1CA46-8-4	1CA48-8-4	6	1/4	-4	6.4	M14x1.5	8	47	24	17
1CA46-10-4	1CA48-10-4	6	1/4	-4	6.4	M16x1.5	10	47	22	19
1CA46-12-4	1CA48-12-4	6	1/4	-4	6.4	M18x1.5	12	46	22	22
1CA46-8-5	1CA48-8-5	8	5/16	-5	7.9	M14x1.5	8	50	26	17
1CA46-10-5	1CA48-10-5	8	5/16	-5	7.9	M16x1.5	10	46	23	19
1CA46-12-5	1CA48-12-5	8	5/16	-5	7.9	M18x1.5	12	46	22	22
1CA46-8-6	1CA48-8-6	10	3/8	-6	9.5	M14x1.5	8	49	26	17
1CA46-10-6	1CA48-10-6	10	3/8	-6	9.5	M16x1.5	10	46	23	19
1CA46-12-6	1CA48-12-6	10	3/8	-6	9.5	M18x1.5	12	46	23	22
1CA46-15-6	1CA48-15-6	10	3/8	-6	9.5	M22x1.5	15	47	24	27
1CA46-18-6	1CA48-18-6	10	3/8	-6	9.5	M26x1.5	18	50	28	32
1CA46-12-8	1CA48-12-8	12	1/2	-8	12.7	M18x1.5	12	50	26	22
1CA46-15-8	1CA48-15-8	12	1/2	-8	12.7	M22x1.5	15	50	26	27
1CA46-18-8	1CA48-18-8	12	1/2	-8	12.7	M26x1.5	18	49	25	32
1CA46-15-10	1CA48-15-10	16	5/8	-10	15.9	M22x1.5	15	54	29	27
1CA46-18-10	1CA48-18-10	16	5/8	-10	15.9	M26x1.5	18	50	25	32
1CA46-22-10	1CA48-22-10	16	5/8	-10	15.9	M30x2	22	58	33	36
1CA46-18-12	1CA48-18-12	19	3/4	-12	19.1	M26x1.5	18	51	25	32
1CA46-22-12	1CA48-22-12	19	3/4	-12	19.1	M30x2	22	56	30	36
1CA46-28-12	1CA48-28-12	19	3/4	-12	19.1	M36x2	28	61	35	41
1CA46-22-16	1CA48-22-16	25	1	-16	25.4	M30x2	22	60	30	36
1CA46-28-16	1CA48-28-16	25	1	-16	25.4	M36x2	28	63	33	41
1CA46-35-16	1CA48-35-16	25	1	-16	25.4	M45x2	35	63	33	50
	1CA48-28-20	31	1 1/4	-20	31.8	M36x2	28	81	34	41
1CA46-35-20		31	1 1/4	-20	31.8	M45x2	35	69	31	50
	1CA48-35-20	31	1 1/4	-20	31.8	M45x2	35	82	35	50
	1CA48-42-20	31	1 1/4	-20	31.8	M52x2	42	82	35	60
	1CA48-35-24	38	1 1/2	-24	38.1	M45x2	35	75	37	50
	1CA48-42-24	38	1 1/2	-24	38.1	M52x2	42	77	39	60

Hose fittings are delivered with ozone resistant Nitrile (NBR) O-ring as a standard version. Working temperature from -40 °C up to +105 °C. Hose fittings with special O-rings (Viton or EPDM) available on request. O-ring dimensions and part-numbers see in section Eb.

46/48 Series

Approved **fitting series** for **hose types**, depending on size: Also available in stainless steel. Details can be found in CAT 4400.1/UK

46 or 48	441	461LT	462	462TC	462ST	629PU	692PU Twin										
46	463	492	492ST	492TC	692	692Twin	692TC	BCH1									
48	301SN	304	387	387ST	387TC	421RH	421SN	426	421TC	436	441RH	462PU	462PU Twin	BCH2	HT2	...	
	471TC	477	477ST	477TC	477RH	487	487ST	487TC	493	787	787TC	787ST	797	797TC	797ST	811	881

CE **Female Metric 24°
Light Series with O-Ring
Swivel – 45° Elbow**
ISO 12151-2-SWE -L – DKOL 45°

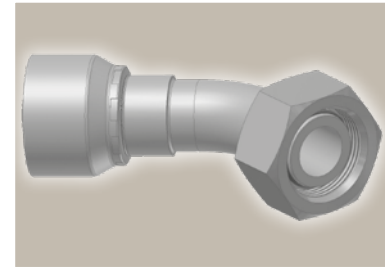
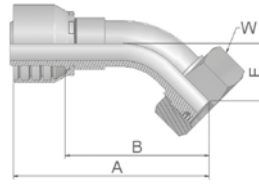

Part Number		Hose I.D.				Thread	Tube	A	B	E	W
46 series	48 series	DN	Inch	Size	mm	metric	O.D. mm	mm	mm	mm	mm
1CE46-6-4		6	1/4	-4	6.4	M12x1.5	6	69	46	19	14
	1CE48-6-4	6	1/4	-4	6.4	M12x1.5	6	70	45	19	14
1CE46-8-4	1CE48-8-4	6	1/4	-4	6.4	M14x1.5	8	59	36	16	17
1CE46-10-4	1CE48-10-4	6	1/4	-4	6.4	M16x1.5	10	59	36	16	19
1CE46-12-4	1CE48-12-4	6	1/4	-4	6.4	M18x1.5	12	60	36	16	22
1CE46-8-5	1CE48-8-5	8	5/16	-5	7.9	M14x1.5	8	65	41	20	17
1CE46-10-5	1CE48-10-5	8	5/16	-5	7.9	M16x1.5	10	68	44	16	19
1CE46-12-5	1CE48-12-5	8	5/16	-5	7.9	M18x1.5	12	61	38	17	22
1CE46-10-6	1CE48-10-6	10	3/8	-6	9.5	M16x1.5	10	68	45	20	19
1CE46-12-6	1CE48-12-6	10	3/8	-6	9.5	M18x1.5	12	68	45	19	22
1CE46-15-6	1CE48-15-6	10	3/8	-6	9.5	M22x1.5	15	68	45	19	27
1CE46-12-8	1CE48-12-8	12	1/2	-8	12.7	M18x1.5	12	74	51	23	22
1CE46-15-8	1CE48-15-8	12	1/2	-8	12.7	M22x1.5	15	71	47	22	27
1CE46-18-8	1CE48-18-8	12	1/2	-8	12.7	M26x1.5	18	71	47	22	32
1CE46-15-10	1CE48-15-10	16	5/8	-10	15.9	M22x1.5	15	79	54	26	27
1CE46-18-10	1CE48-18-10	16	5/8	-10	15.9	M26x1.5	18	75	50	23	32
1CE46-18-12	1CE48-18-12	19	3/4	-12	19.1	M26x1.5	18	90	64	27	32
1CE46-22-12	1CE48-22-12	19	3/4	-12	19.1	M30x2	22	88	62	26	36
1CE46-28-12	1CE48-28-12	19	3/4	-12	19.1	M36x2	28	90	64	28	41
1CE46-22-16	1CE48-22-16	25	1	-16	25.4	M30x2	22	112	82	35	36
1CE46-28-16		25	1	-16	25.4	M36x 2	28	113	83	33	41
	1CE48-28-16	25	1	-16	25.4	M36x2	28	113	83	33	41
	1CE48-28-20	31	1 1/4	-20	31.8	M36x2	28	142	95	39	41
1CE46-35-20		31	1 1/4	-20	31.8	M45x2	35	130	92	32	50
	1CE48-35-20	31	1 1/4	-20	31.8	M45x2	35	141	94	37	50
	1CE48-42-24	38	1 1/2	-24	38.1	M52x2	42	155	117	49	60

Hose fittings are delivered with ozone resistant Nitrile (NBR) O-ring as a standard version. Working temperature from -40 °C up to +105 °C.
Hose fittings with special O-rings (Viton or EPDM) available on request. O-ring dimensions and part-numbers see in section Eb.

Approved **fitting series** for **hose types**, depending on size: Also available in stainless steel. Details can be found in CAT 4400.1/UK

46 or 48	441	461LT	462	462TC	462ST	629PU	692PU Twin										
46	463	492	492ST	492TC	692	692Twin	692TC	BCH1									
48	301SN	304	387	387ST	387TC	421RH	421SN	426	421TC	436	441RH	462PU	462PU Twin	BCH2	HT2	...	
	471TC	477	477ST	477TC	477RH	487	487ST	487TC	493	787	787TC	787ST	797	797TC	797ST	811	881

CF **Female Metric 24°
Light Series with O-Ring
Swivel – 90° Elbow**
ISO 12151-2-SWE-L – DKOL 90°

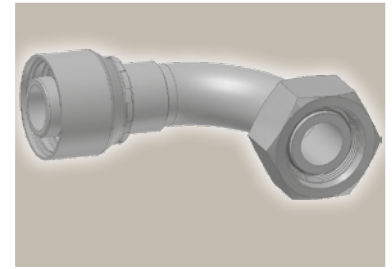
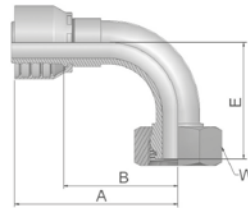

Part Number		Hose I.D.				Thread	Tube O.D.	A	B	E	W
46 series	48 series	DN	Inch	Size	mm	metric	mm	mm	mm	mm	
1CF46-6-4	1CF48-6-4	6	1/4	-4	6.4	M12x1.5	6	57	33	33	14
1CF46-8-4	1CF48-8-4	6	1/4	-4	6.4	M14x1.5	8	51	28	29	17
1CF46-10-4	1CF48-10-4	6	1/4	-4	6.4	M16x1.5	10	52	28	29	19
1CF46-12-4	1CF48-12-4	6	1/4	-4	6.4	M18x1.5	12	53	26	29	22
1CF46-8-5	1CF48-8-5	8	5/16	-5	7.9	M14x1.5	8	62	38	35	17
1CF46-10-5	1CF48-10-5	8	5/16	-5	7.9	M16x1.5	10	61	37	29	19
1CF46-12-5	1CF48-12-5	8	5/16	-5	7.9	M18x1.5	12	60	37	30	22
1CF46-10-6	1CF48-10-6	10	3/8	-6	9.5	M16x1.5	10	60	37	37	19
1CF46-12-6	1CF48-12-6	10	3/8	-6	9.5	M18x1.5	12	58	36	35	22
1CF46-15-6	1CF48-15-6	10	3/8	-6	9.5	M22x1.5	15	58	35	36	27
1CF46-12-8	1CF48-12-8	12	1/2	-8	12.7	M18x1.5	12	63	39	45	22
1CF46-15-8	1CF48-15-8	12	1/2	-8	12.7	M22x1.5	15	61	37	43	27
1CF46-18-8	1CF48-18-8	12	1/2	-8	12.7	M26x1.5	18	65	41	43	32
1CF46-15-10	1CF48-15-10	16	5/8	-10	15.9	M22x1.5	15	67	42	50	27
1CF46-18-10	1CF48-18-10	16	5/8	-10	15.9	M26x1.5	18	66	41	45	32
1CF46-22-10	1CF48-22-10	16	5/8	-10	15.9	M30x2	22	71	46	47	36
1CF46-18-12	1CF48-18-12	19	3/4	-12	19.1	M26x1.5	18	80	54	56	32
1CF46-22-12	1CF48-22-12	19	3/4	-12	19.1	M30x2	22	80	54	55	36
1CF46-28-12	1CF48-28-12	19	3/4	-12	19.1	M36x2	28	80	54	57	41
1CF46-22-16	1CF48-22-16	25	1	-16	25.4	M30x2	22	102	72	74	36
1CF46-28-16	1CF48-28-16	25	1	-16	25.4	M36x2	28	101	72	71	41
	1CF48-22-20	31	1 1/4	-20	31.8	M30x2	22	130	83	81	36
1CF46-28-20		31	1 1/4	-20	31.8	M36x2	28	124	86	81	41
	1CF48-28-20	31	1 1/4	-20	31.8	M36x2	28	129	82	81	41
1CF46-35-20		31	1 1/4	-20	31.8	M45x2	35	124	86	79	50
	1CF48-35-20	31	1 1/4	-20	31.8	M45x2	35	130	83	79	50
	1CF48-35-24	38	1 1/2	-24	38.1	M45x2	35	139	101	99	50
	1CF48-42-24	38	1 1/2	-24	38.1	M52x2	42	139	101	101	60

Hose fittings are delivered with ozone resistant Nitrile (NBR) O-ring as a standard version. Working temperature from -40 °C up to +105 °C. Hose fittings with special O-rings (Viton or EPDM) available on request. O-ring dimensions and part-numbers see in section Eb.

46/48 Series

Approved **fitting series** for hose types, depending on size: Also available in stainless steel. Details can be found in CAT 4400.1/UK

46 or 48	441	461LT	462	462TC	462ST	629PU	692PU Twin										
46	463	492	492ST	492TC	692	692Twin	692TC	BCH1									
48	301SN	304	387	387ST	387TC	421RH	421SN	426	421TC	436	441RH	462PU	462PU Twin	BCH2	HT2	...	
	471TC	477	477ST	477TC	477RH	487	487ST	487TC	493	787	787TC	787ST	797	797TC	797ST	811	881

D0 **Male Metric 24°
Light Series – Rigid
Straight**

ISO 12151-2-S-L – CEL

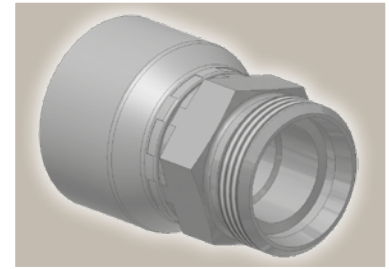
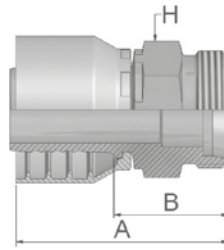

Part Number		Hose I.D.				Thread	Tube O.D.	A	B	H
46 series	48 series	DN	Inch	Size	mm	metric	mm	mm	mm	
1D046-6-4	1D048-6-4	6	1/4	-4	6.4	M12x1.5	6	44	20	12
1D046-8-4	1D048-8-4	6	1/4	-4	6.4	M14x1.5	8	46	22	14
1D046-10-4	1D048-10-4	6	1/4	-4	6.4	M16x1.5	10	48	24	17
1D046-12-4	1D048-12-4	6	1/4	-4	6.4	M18x1.5	12	48	24	19
1D046-8-5	1D048-8-5	8	5/16	-5	7.9	M14x1.5	8	44	20	14
1D046-10-5		8	5/16	-5	7.9	M16x1.5	10	47	24	17
	1D048-10-5	8	5/16	-5	7.9	M16x1.5	10	48	24	17
1D046-12-5	1D048-12-5	8	5/16	-5	7.9	M18x1.5	12	48	24	19
1D046-10-6	1D048-10-6	10	3/8	-6	9.5	M16x1.5	10	47	24	17
1D046-12-6	1D048-12-6	10	3/8	-6	9.5	M18x1.5	12	47	24	19
1D046-15-6	1D048-15-6	10	3/8	-6	9.5	M22x1.5	15	49	26	22
1D046-12-8		12	1/2	-8	12.7	M18x1.5	12	47	23	19
1D046-15-8	1D048-15-8	12	1/2	-8	12.7	M22x1.5	15	50	26	22
1D046-18-8	1D048-18-8	12	1/2	-8	12.7	M26x1.5	18	53	29	27
1D046-15-10	1D048-15-10	16	5/8	-10	15.9	M22x1.5	15	57	29	27
1D046-18-10	1D048-18-10	16	5/8	-10	15.9	M26x1.5	18	54	29	27
1D046-18-12	1D048-18-12	19	3/4	-12	19.1	M26x1.5	18	55	29	27
1D046-22-12	1D048-22-12	19	3/4	-12	19.1	M30x2	22	59	33	30
1D046-28-12	1D048-28-12	19	3/4	-12	19.1	M36x2	28	60	34	36
1D046-28-16	1D048-28-16	25	1	-16	25.4	M36x2	28	65	35	36
1D046-35-20		31	1 1/4	-20	31.8	M45x2	35	78	40	46
	1D048-35-20	31	1 1/4	-20	31.8	M45x2	35	85	38	46
	1D048-42-24	38	1 1/2	-24	38.1	M52x2	42	77	39	55

Approved **fitting series** for **hose types**, depending on size: Also available in stainless steel. Details can be found in CAT 4400.1/UK

46 or 48	441	461LT	462	462TC	462ST	629PU	692PU Twin										
46	463	492	492ST	492TC	692	692Twin	692TC	BCH1									
48	301SN	304	387	387ST	387TC	421RH	421SN	426	421TC	436	441RH	462PU	462PU Twin	BCH2	HT2	...	
	471TC	477	477ST	477TC	477RH	487	487ST	487TC	493	787	787TC	787ST	797	797TC	797ST	811	881

C9 Female Metric 24° – Swivel Heavy Series with O-Ring Straight

ISO 12151-2-SWS-S – DKOS

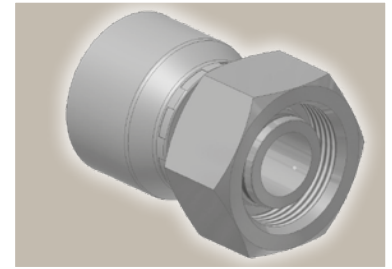
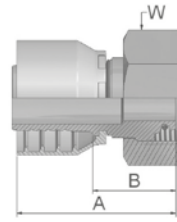

Part Number		Hose I.D.				Thread	Tube O.D.	A	B	W
46 series	48 series	DN	Inch	Size	mm	metric	mm	mm	mm	mm
1C946-6-4		6	1/4	-4	6.4	M14x1.5	6	48	26	17
	1C948-6-4	6	1/4	-4	6.4	M14x1.5	6	49	26	17
1C946-8-4	1C948-8-4	6	1/4	-4	6.4	M16x1.5	8	47	23	19
1C946-10-4	1C948-10-4	6	1/4	-4	6.4	M18x1.5	10	46	22	22
1C946-12-4	1C948-12-4	6	1/4	-4	6.4	M20x1.5	12	47	24	24
1C946-14-4	1C948-14-4	6	1/4	-4	6.4	M22x1.5	14	48	24	27
1C946-8-5	1C948-8-5	8	5/16	-5	7.9	M16x1.5	8	46	23	19
1C946-10-5	1C948-10-5	8	5/16	-5	7.9	M18x1.5	10	46	22	22
1C946-12-5	1C948-12-5	8	5/16	-5	7.9	M20x1.5	12	48	24	24
1C946-14-5	1C948-14-5	8	5/16	-5	7.9	M22x1.5	14	48	24	27
1C946-16-5	1C948-16-5	8	5/16	-5	7.9	M24x1.5	16	52	28	30
1C946-8-6	1C948-8-6	10	3/8	-6	9.5	M16x1.5	8	49	26	19
1C946-10-6	1C948-10-6	10	3/8	-6	9.5	M18x1.5	10	45	22	22
1C946-12-6	1C948-12-6	10	3/8	-6	9.5	M20x1.5	12	47	24	24
1C946-14-6	1C948-14-6	10	3/8	-6	9.5	M22x1.5	14	47	24	27
1C946-16-6	1C948-16-6	10	3/8	-6	9.5	M24x1.5	16	50	28	30
1C946-12-8	1C948-12-8	12	1/2	-8	12.7	M20x1.5	12	51	28	24
1C946-14-8	1C948-14-8	12	1/2	-8	12.7	M22x1.5	14	48	24	27
1C946-16-8	1C948-16-8	12	1/2	-8	12.7	M24x1.5	16	51	28	30
1C946-20-8	1C948-20-8	12	1/2	-8	12.7	M30x2	20	53	29	36
1C946-16-10	1C948-16-10	16	5/8	-10	15.9	M24x1.5	16	53	28	30
1C946-20-10	1C948-20-10	16	5/8	-10	15.9	M30x2	20	53	28	36
	1C948-12-12	19	3/4	-12	19.1	M20x1.5	12	53	28	24
	1C948-16-12	19	3/4	-12	19.1	M24x1.5	16	55	29	30
1C946-20-12	1C948-20-12	19	3/4	-12	19.1	M30x2	20	56	30	36
1C946-25-12	1C948-25-12	19	3/4	-12	19.1	M36x2	25	61	35	46
1C946-25-16	1C948-25-16	25	1	-16	25.4	M36x2	25	63	33	46
1C946-30-16	1C948-30-16	25	1	-16	25.4	M42x2	30	67	38	50
	1C948-25-20	31	1 1/4	-20	31.8	M36x2	25	81	34	46
1C946-38-20		31	1 1/4	-20	31.8	M52x2	38	74	36	60
	1C948-38-20	31	1 1/4	-20	31.8	M52x2	38	80	33	60

Hose fittings are delivered with ozone resistant Nitrile (NBR) O-ring as a standard version. Working temperature from -40 °C up to +105 °C.
Hose fittings with special O-rings (Viton or EPDM) available on request. O-ring dimensions and part-numbers see in section Eb.

46/48 Series

Approved **fitting series** for **hose types**, depending on size: Also available in stainless steel. Details can be found in CAT 4400.1/UK

46 or 48	441	461LT	462	462TC	462ST	629PU	692PU Twin										
46	463	492	492ST	492TC	692	692Twin	692TC	BCH1									
48	301SN	304	387	387ST	387TC	421RH	421SN	426	421TC	436	441RH	462PU	462PU Twin	BCH2	HT2	...	
	471TC	477	477ST	477TC	477RH	487	487ST	487TC	493	787	787TC	787ST	797	797TC	797ST	811	881

0C Female Metric 24° – Swivel Heavy Series with O-Ring 45° Elbow

ISO 12151-2 – SWE -S – DKOS 45°

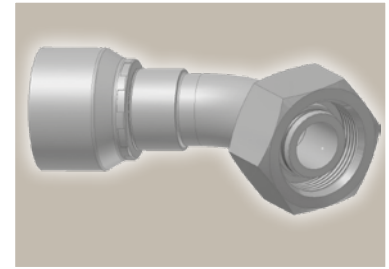
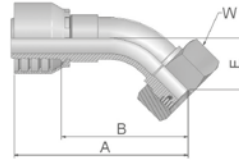

Part Number		Hose I.D.				Thread	Tube	A	B	E	W
46 series	48 series	DN	Inch	Size	mm	metric	O.D. mm	mm	mm	mm	mm
10C46-6-4	10C48-6-4	6	1/4	-4	6.4	M14x1.5	6	61	38	16	17
10C46-8-4	10C48-8-4	6	1/4	-4	6.4	M16x1.5	8	59	35	16	19
10C46-10-4	10C48-10-4	6	1/4	-4	6.4	M18x1.5	10	59	36	16	22
10C46-12-4	10C48-12-4	6	1/4	-4	6.4	M20x1.5	12	71	48	17	24
10C46-10-5	10C48-10-5	8	5/16	-5	7.9	M18x1.5	10	62	38	17	22
10C46-12-5	10C48-12-5	8	5/16	-5	7.9	M20x1.5	12	70	47	17	24
10C46-10-6	10C48-10-6	10	3/8	-6	9.5	M18x1.5	10	70	47	19	22
10C46-12-6	10C48-12-6	10	3/8	-6	9.5	M20x1.5	12	69	46	20	24
10C46-14-6	10C48-14-6	10	3/8	-6	9.5	M22x1.5	14	69	46	20	27
10C46-14-8	10C48-14-8	12	1/2	-8	12.7	M22x1.5	14	69	46	21	27
10C46-16-8	10C48-16-8	12	1/2	-8	12.7	M24x1.5	16	72	49	23	30
10C46-16-10	10C48-16-10	16	5/8	-10	15.9	M24x1.5	16	77	52	24	30
10C46-20-10	10C48-20-10	16	5/8	-10	15.9	M30x2	20	76	51	25	36
10C46-20-12	10C48-20-12	19	3/4	-12	19.1	M30x2	20	90	64	28	36
10C46-25-12	10C48-25-12	19	3/4	-12	19.1	M36x2	25	91	65	29	46
	10C48-30-12	19	3/4	-12	19.1	M42x2	30	93	67	30	50
10C46-25-16		25	1	-16	25.4	M36x2	25	109	80	33	46
	10C48-25-16	25	1	-16	25.4	M36x2	30	109	80	33	46
10C46-30-16	10C48-30-16	25	1	-16	25.4	M42x2	30	115	86	36	50
10C46-38-20		31	1 1/4	-20	31.8	M52x2	38	136	98	38	60
	10C48-38-20	31	1 1/4	-20	31.8	M52x2	38	140	93	37	60
	10C48-38-24	38	1 1/2	-24	38.1	M52x2	38	155	117	49	60

Hose fittings are delivered with ozone resistant Nitrile (NBR) O-ring as a standard version. Working temperature from -40 °C up to +105 °C. Hose fittings with special O-rings (Viton or EPDM) available on request. O-ring dimensions and part-numbers see in section Eb.

Approved **fitting series** for **hose types**, depending on size: Also available in stainless steel. Details can be found in CAT 4400.1/UK

46 or 48	441	461LT	462	462TC	462ST	629PU	692PU Twin										
46	463	492	492ST	492TC	692	692Twin	692TC	BCH1									
48	301SN	304	387	387ST	387TC	421RH	421SN	426	421TC	436	441RH	462PU	462PU Twin	BCH2	HT2	...	
	471TC	477	477ST	477TC	477RH	487	487ST	487TC	493	787	787TC	787ST	797	797TC	797ST	811	881

1C

Female Metric 24° – Swivel Heavy Series with O-Ring 90° Elbow

ISO 12151-2-SWE-S – DKOS 90°

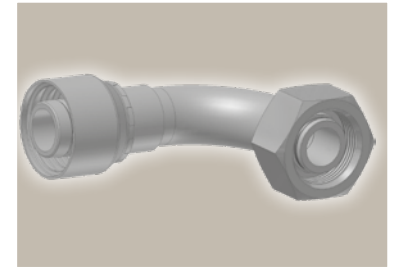
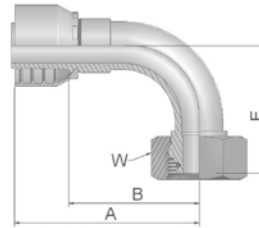

Part Number		Hose I.D.				Thread	Tube O.D.	A	B	E	W
46 series	48 series	DN	Inch	Size	mm	metric	mm	mm	mm	mm	
11C46-6-4	11C48-6-4	6	1/4	-4	6.4	M14x1.5	6	62	39	32	17
11C46-8-4	11C48-8-4	6	1/4	-4	6.4	M16x1.5	8	50	26	29	19
11C46-10-4	11C48-10-4	6	1/4	-4	6.4	M18x1.5	10	50	26	29	22
11C46-12-4	11C48-12-4	6	1/4	-4	6.4	M20x1.5	12	60	38	30	24
11C46-10-5	11C48-10-5	8	5/16	-5	7.9	M18x1.5	10	60	36	31	22
11C46-12-5	11C48-12-5	8	5/16	-5	7.9	M20x1.5	12	60	36	32	24
11C46-10-6	11C48-10-6	10	3/8	-6	9.5	M18x1.5	10	59	37	36	22
11C46-12-6	11C48-12-6	10	3/8	-6	9.5	M20x1.5	12	58	35	37	24
11C46-14-6	11C48-14-6	10	3/8	-6	9.5	M22x1.5	14	58	35	37	27
	11C48-16-6	10	3/8	-6	9.5	M24x1.5	16	63	38	40	30
	11C48-12-8	12	1/2	-8	12.7	M20x1.5	12	63	39	44	24
11C46-14-8	11C48-14-8	12	1/2	-8	12.7	M22x1.5	14	62	38	42	27
11C46-16-8	11C48-16-8	12	1/2	-8	12.7	M24x1.5	16	61	37	45	30
11C46-20-8	11C48-20-8	12	1/2	-8	12.7	M30x2	20	61	37	46	36
11C46-16-10	11C48-16-10	16	5/8	-10	15.9	M24x1.5	16	66	41	48	30
11C46-20-10	11C48-20-10	16	5/8	-10	15.9	M30x2	20	65	40	48	36
11C46-25-10	11C48-25-10	16	5/8	-10	15.9	M36x2	25	76	51	52	46
11C46-20-12	11C48-20-12	19	3/4	-12	19.1	M30x2	20	79	54	58	36
11C46-25-12	11C48-25-12	19	3/4	-12	19.1	M36x2	25	80	54	59	46
	11C48-30-12	19	3/4	-12	19.1	M42x2	30	80	55	61	50
11C46-25-16	11C48-25-16	25	1	-16	25.4	M36x2	25	102	72	71	46
11C46-30-16	11C48-30-16	25	1	-16	25.4	M42x2	30	104	75	75	50
	11C48-30-20	31	1 1/4	-20	31.8	M42x2	30	130	83	86	50
11C46-38-20		31	1 1/4	-20	31.8	M52x2	38	124	86	80	60
	11C48-38-20	31	1 1/4	-20	31.8	M52x2	38	130	83	78	60
	11C48-38-24	38	1 1/2	-24	38.1	M52x2	38	139	101	101	60

Hose fittings are delivered with ozone resistant Nitrile (NBR) O-ring as a standard version. Working temperature from -40 °C up to +105 °C. Hose fittings with special O-rings (Viton or EPDM) available on request. O-ring dimensions and part-numbers see in section Eb.

46/48 Series

Approved **fitting series** for hose types, depending on size: Also available in stainless steel. Details can be found in CAT 4400.1/UK

46	or	48	441	461LT	462	462TC	462ST	629PU	692PU Twin								
46	463	492	492ST	492TC	692	692Twin	692TC	BCH1									
48	301SN	304	387	387ST	387TC	421RH	421SN	426	421TC	436	441RH	462PU	462PU Twin	BCH2	HT2	...	
	471TC	477	477ST	477TC	477RH	487	487ST	487TC	493	787	787TC	787ST	797	797TC	797ST	811	881

D2 **Male Metric 24° – Rigid
Heavy Series – Straight**
ISO 12151-2-S-S – CES

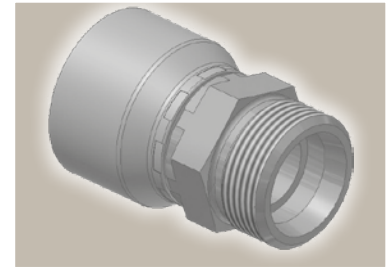
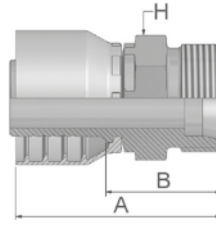

Part Number		Hose I.D.				Thread	Tube O.D.	A	B	H
46 series	48 series	DN	Inch	Size	mm	metric	mm	mm	mm	
1D246-6-4	1D248-6-4	6	1/4	-4	6.4	M14x1.5	6	48	24	14
1D246-8-4	1D248-8-4	6	1/4	-4	6.4	M16x1.5	8	48	24	17
1D246-10-4	1D248-10-4	6	1/4	-4	6.4	M18x1.5	10	50	26	19
1D246-12-4	1D248-12-4	6	1/4	-4	6.4	M20x1.5	12	48	26	22
1D246-8-5	1D248-8-5	8	5/16	-5	7.9	M16x1.5	8	48	24	17
1D246-10-5	1D248-10-5	8	5/16	-5	7.9	M18x1.5	10	50	26	19
1D246-12-5	1D248-12-5	8	5/16	-5	7.9	M20x1.5	12	50	26	22
1D246-14-5	1D248-14-5	8	5/16	-5	7.9	M22x1.5	14	51	28	22
	1D248-16-5	8	5/16	-5	7.9	M24x1.5	16	53	29	24
1D246-10-6	1D248-10-6	10	3/8	-6	9.5	M18x1.5	10	50	27	19
1D246-12-6	1D248-12-6	10	3/8	-6	9.5	M20x1.5	12	49	26	22
1D246-14-6	1D248-14-6	10	3/8	-6	9.5	M22x1.5	14	51	28	22
1D246-12-8	1D248-12-8	12	1/2	-8	12.7	M20x1.5	12	49	26	22
	1D248-14-8	12	1/2	-8	12.7	M22x1.5	14	52	28	22
1D246-16-8	1D248-16-8	12	1/2	-8	12.7	M24x1.5	16	52	29	24
	1D248-20-8	12	1/2	-8	12.7	M30x2	20	58	35	30
1D246-16-10	1D248-16-10	16	5/8	-10	15.9	M24x1.5	16	58	30	24
1D246-20-10	1D248-20-10	16	5/8	-10	15.9	M30x2	20	58	32	30
	1D248-16-12	19	3/4	-12	19.1	M24x1.5	16	56	31	27
1D246-20-12	1D248-20-12	19	3/4	-12	19.1	M30x2	20	61	35	30
1D246-25-12	1D248-25-12	19	3/4	-12	19.1	M36x2	25	64	38	36
1D246-25-16	1D248-25-16	25	1	-16	25.4	M36x2	25	68	39	36
1D246-30-16	1D248-30-16	25	1	-16	25.4	M42x2	30	71	42	46
1D246-38-20		31	1 1/4	-20	31.8	M52x2	38	84	46	55
	1D248-38-20	31	1 1/4	-20	31.8	M52x2	38	91	44	55
	1D248-38-24	38	1 1/2	-24	38.1	M52x2	38	84	46	55

Approved **fitting series** for **hose types**, depending on size: Also available in stainless steel. Details can be found in CAT 4400.1/UK

46 or 48	441	461LT	462	462TC	462ST	629PU	692PU Twin										
46	463	492	492ST	492TC	692	692Twin	692TC	BCH1									
48	301SN	304	387	387ST	387TC	421RH	421SN	426	421TC	436	441RH	462PU	462PU Twin	BCH2	HT2	...	
	471TC	477	477ST	477TC	477RH	487	487ST	487TC	493	787	787TC	787ST	797	797TC	797ST	811	881

49

**Metric Banjo
Straight**

DIN 7642

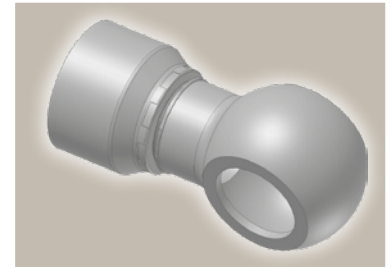
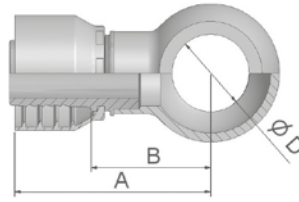

Part Number		Hose I.D.				A	B	D
46 series	48 series	DN	Inch	Size	mm	mm	mm	mm
14946-10-4	14948-10-4	6	1/4	-4	6.4	47	24	10
14946-12-4	14948-12-4	6	1/4	-4	6.4	50	26	12
14946-14-4	14948-14-4	6	1/4	-4	6.4	51	28	14
	14948-16-4	6	1/4	-4	6.4	55.6	29	16.1
14946-14-5	14948-14-5	8	5/16	-5	7.9	51	28	14
14946-16-5	14948-16-5	8	5/16	-5	7.9	53	30	16
14946-16-6	14948-16-6	10	3/8	-6	9.5	53	30	16
14946-17-6	14948-17-6	10	3/8	-6	9.5	53	30	17
14946-18-6	14948-18-6	10	3/8	-6	9.5	55	32	18
14946-22-6	14948-22-6	10	3/8	-6	9.5	58	35	22
14946-18-8	14948-18-8	12	1/2	-8	12.7	56	32	18
14946-22-8	14948-22-8	12	1/2	-8	12.7	59	35	22
14946-22-10	14948-22-10	16	5/8	-10	15.9	60	35	22
14946-26-12	14948-26-12	19	3/4	-12	19.1	66	40	26
14946-27-12	14948-27-12	19	3/4	-12	19.1	66	40	27

To select corresponding screw and seals see section Eb.

Approved **fitting series** for hose types, depending on size: Also available in stainless steel. Details can be found in CAT 4400.1/UK

46 or 48	441	461LT	462	462TC	462ST	629PU	692PU Twin										
46	463	492	492ST	492TC	692	692Twin	692TC	BCH1									
48	301SN	304	387	387ST	387TC	421RH	421SN	426	421TC	436	441RH	462PU	462PU Twin	BCH2	HT2	...	
	471TC	477	477ST	477TC	477RH	487	487ST	487TC	493	787	787TC	787ST	797	797TC	797ST	811	881

92 Female BSP Parallel Pipe Swivel – Straight (60° Cone)

BS5200-A – DKR

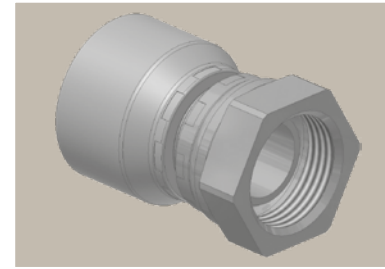
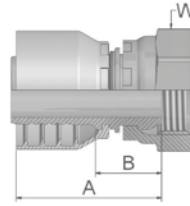

Part Number		Hose I.D.				Thread	A	B	W
46 series	48 series	DN	Inch	Size	mm	BSP	mm	mm	mm
19246-2-4	19248-2-4	6	1/4	-4	6.4	1/8x28	41	17	14
19246-4-4		6	1/4	-4	6.4	1/4x19	46	19	19
	19248-4-4	6	1/4	-4	6.4	1/4x19	43	19	19
19246-6-4	19248-6-4	6	1/4	-4	6.4	3/8x19	44	20	22
19246-8-4	19248-8-4	6	1/4	-4	6.4	1/2x14	49	25	27
19246-4-5	19248-4-5	8	5/16	-5	7.9	1/4x19	43	19	19
19246-6-5	19248-6-5	8	5/16	-5	7.9	3/8x19	44	20	22
19246-4-6	19248-4-6	10	3/8	-6	9.5	1/4x19	43	20	19
19246-6-6	19248-6-6	10	3/8	-6	9.5	3/8x19	43	20	22
19246-8-6	19248-8-6	10	3/8	-6	9.5	1/2x14	45	22	27
19246-6-8	19248-6-8	12	1/2	-8	12.7	3/8x19	45	21	22
19246-8-8	19248-8-8	12	1/2	-8	12.7	1/2x14	45	22	27
19246-10-8	19248-10-8	12	1/2	-8	12.7	5/8x14	44	20	30
19246-12-8	19248-12-8	12	1/2	-8	12.7	3/4x14	47	23	32
19246-8-10	19248-8-10	16	5/8	-10	15.9	1/2x14	48	22	27
19246-10-10	19248-10-10	16	5/8	-10	15.9	5/8x14	45	20	30
19246-12-10	19248-12-10	16	5/8	-10	15.9	3/4x14	47	22	32
19246-8-12	19248-8-12	19	3/4	-12	19.1	1/2x14	49	23	27
19246-10-12	19248-10-12	19	3/4	-12	19.1	5/8x14	47	22	30
19246-12-12	19248-12-12	19	3/4	-12	19.1	3/4x14	49	23	32
19246-16-12	19248-16-12	19	3/4	-12	19.1	1x11	51	25	41
19246-16-16	19248-16-16	25	1	-16	25.4	1x11	55	25	41
	19248-20-16	25	1	-16	25.4	1 1/4x11	63	31	50
19246-20-20		31	1 1/4	-20	31.8	1 1/4x11	68	31	50
	19248-20-20	31	1 1/4	-20	31.8	1 1/4x11	79	32	50
	19248-24-24	38	1 1/2	-24	38.1	1 1/2x11	71	33	60
	19248-32-32	51	2	-32	50.8	2x11	84	35	70

Approved fitting series for hose types, depending on size: Also available in stainless steel. Details can be found in CAT 4400.1/UK

46 or 48	441	461LT	462	462TC	462ST	629PU	692PU Twin										
46	463	492	492ST	492TC	692	692Twin	692TC	BCH1									
48	301SN	304	387	387ST	387TC	421RH	421SN	426	421TC	436	441RH	462PU	462PU Twin	BCH2	HT2	...	
	471TC	477	477ST	477TC	477RH	487	487ST	487TC	493	787	787TC	787ST	797	797TC	797ST	811	881

B1 Female BSP Parallel Pipe Swivel 45° Elbow (60° Cone)

BS 5200-D – DKR 45°

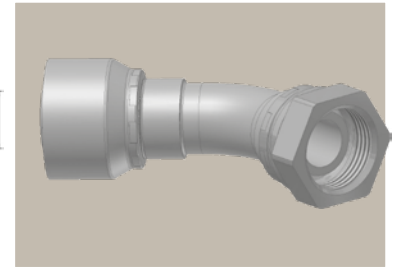
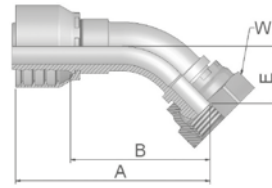

Part Number		Hose I.D.				Thread	A	B	E	W
46 series	48 series	DN	Inch	Size	mm	BSP	mm	mm	mm	mm
1B146-4-4		6	1/4	-4	6.4	1/4x19	59	35	16	19
	1B148-4-4	6	1/4	-4	6.4	1/4x19	58	35	16	19
1B146-6-4	1B148-6-4	6	1/4	-4	6.4	3/8x19	59	35	14	22
1B146-6-5	1B148-6-5	8	5/16	-5	7.9	3/8x19	60	36	15	22
1B146-6-6	1B148-6-6	10	3/8	-6	9.5	3/8x19	69	46	17	22
1B146-8-6	1B148-8-6	10	3/8	-6	9.5	1/2x14	63	40	17	27
1B146-8-8	1B148-8-8	12	1/2	-8	12.7	3/8x19	72	49	21	22
1B146-8-8	1B148-8-8	12	1/2	-8	12.7	1/2x14	72	49	20	27
1B146-10-8	1B148-10-8	12	1/2	-8	12.7	5/8x14	69	46	19	30
1B146-10-10	1B148-10-10	16	5/8	-10	15.9	5/8x14	77	52	22	30
1B146-12-10	1B148-12-10	16	5/8	-10	15.9	3/4x14	74	49	20	32
1B146-12-12	1B148-12-12	19	3/4	-12	19.1	3/4x14	87	61	25	32
1B146-16-12	1B148-16-12	19	3/4	-12	19.1	1x11	88	62	26	41
1B146-16-16	1B148-16-16	25	1	-16	25.4	1x11	107	78	33	41
1B146-20-20		31	1 1/4	-20	31.8	1 1/4x11	136	98	38	50
	1B148-20-20	31	1 1/4	-20	31.8	1 1/4x11	141	94	38	50
	1B148-24-24	38	1 1/2	-24	38.1	1 1/2x11	160	122	52	55
	1B148-32-32	51	2	-32	50.8	2x11	210	161	66	70

46/48 Series

Approved **fitting series** for hose types, depending on size: Also available in stainless steel. Details can be found in CAT 4400.1/UK

46	or	48	441	461LT	462	462TC	462ST	629PU	692PU Twin								
46	463	492	492ST	492TC	692	692Twin	692TC	BCH1									
48	301SN	304	387	387ST	387TC	421RH	421SN	426	421TC	436	441RH	462PU	462PU Twin	BCH2	HT2	...	
	471TC	477	477ST	477TC	477RH	487	487ST	487TC	493	787	787TC	787ST	797	797TC	797ST	811	881

B2 Female BSP Parallel Pipe Swivel 90° Elbow (60° Cone)

BS 5200-B – DKR 90°

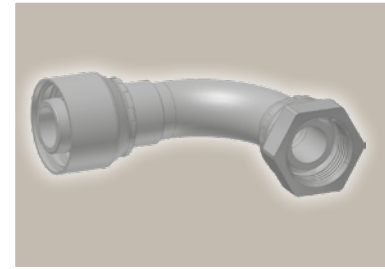
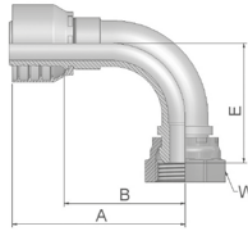

Part Number		Hose I.D.				Thread	A	B	E	W
46 series	48 series	DN	Inch	Size	mm	BSP	mm	mm	mm	mm
1B246-2-4	1B248-2-4	6	1/4	-4	6.4	1/8x28	50	26	30	14
1B246-4-4	1B248-4-4	6	1/4	-4	6.4	1/4x19	50	26	28	19
1B246-6-4		6	1/4	-4	6.4	3/8x19	51	27	28	22
	1B248-6-4	6	1/4	-4	6.4	3/8x19	51	27	27	22
1B246-8-4	1B248-8-4	6	1/4	-4	6.4	1/2x14	51	27	29	27
1B246-6-5	1B248-6-5	8	5/16	-5	7.9	3/8x19	52	28	28	22
1B246-6-6	1B248-6-6	10	3/8	-6	9.5	3/8x19	61	38	33	22
1B246-8-6	1B248-8-6	10	3/8	-6	9.5	1/2x14	60	38	36	27
1B246-6-8	1B248-6-8	12	1/2	-8	12.7	3/8x19	63	40	41	22
1B246-8-8	1B248-8-8	12	1/2	-8	12.7	1/2x14	63	40	41	27
1B246-10-8	1B248-10-8	12	1/2	-8	12.7	5/8x14	67	43	38	30
1B246-10-10	1B248-10-10	16	5/8	-10	15.9	5/8x14	70	45	44	30
1B246-12-10	1B248-12-10	16	5/8	-10	15.9	3/4x14	70	45	42	32
1B246-12-12	1B248-12-12	19	3/4	-12	19.1	3/4x14	80	54	53	32
1B246-16-12	1B248-16-12	19	3/4	-12	19.1	1x11	80	54	54	41
1B246-16-16	1B248-16-16	25	1	-16	25.4	1x11	104	75	69	41
1B246-20-20		31	1 1/4	-20	31.8	1 1/4x11	124	86	80	50
	1B248-20-20	31	1 1/4	-20	31.8	1 1/4x11	129	82	80	50
	1B248-24-24	38	1 1/2	-24	38.1	1 1/2x11	140	102	103	55
	1B248-32-32	51	2	-32	50.8	2x11	185	137	134	70

Approved **fitting series** for **hose types**, depending on size: Also available in stainless steel. Details can be found in CAT 4400.1/UK

46 or 48	441	461LT	462	462TC	462ST	629PU	692PU Twin										
46	463	492	492ST	492TC	692	692Twin	692TC	BCH1									
48	301SN	304	387	387ST	387TC	421RH	421SN	426	421TC	436	441RH	462PU	462PU Twin	BCH2	HT2	...	
	471TC	477	477ST	477TC	477RH	487	487ST	487TC	493	787	787TC	787ST	797	797TC	797ST	811	881

B4 Female BSP Parallel Pipe Swivel – 90° Elbow Block Type (60° Cone)

BS 5200-E – DKR 90°

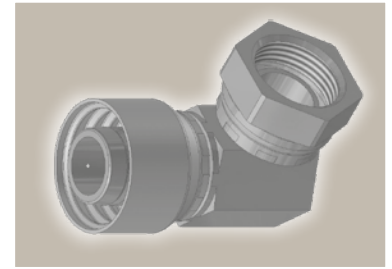
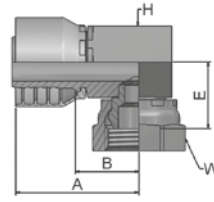

Part Number		Hose I.D.				Thread	A	B	E	H	W
46 series	48 series	DN	Inch	Size	mm	BSP	mm	mm	mm	mm	
1B446-4-4	1B448-4-4	6	1/4	-4	6.4	1/4x19	58	34	22	17	19
1B446-6-4	1B448-6-4	6	1/4	-4	6.4	3/8x19	43	20	22	17	22
1B446-6-6	1B448-6-6	10	3/8	-6	9.5	3/8x19	68	45	23	19	22
1B446-8-6	1B448-8-6	10	3/8	-6	9.5	1/2x14	67	44	27	22	27
1B446-8-8	1B448-8-8	12	1/2	-8	12.7	1/2x14	67	43	27	22	27
1B446-10-10	1B448-10-10	16	5/8	-10	15.9	5/8x14	69	44	27	27	30
1B446-12-12	1B448-12-12	19	3/4	-12	19.1	3/4x14	72	47	33	32	32
1B446-16-16	1B448-16-16	25	1	-16	25.4	1x11	82	52	34	36	41

Short version available upon request (swaging on universal crimpers only)

Approved **fitting series** for hose types, depending on size: Also available in stainless steel. Details can be found in CAT 4400.1/UK

46 or 48	441	461LT	462	462TC	462ST	629PU	692PU Twin										
46	463	492	492ST	492TC	692	692Twin	692TC	BCH1									
48	301SN	304	387	387ST	387TC	421RH	421SN	426	421TC	436	441RH	462PU	462PU Twin	BCH2	HT2	...	
	471TC	477	477ST	477TC	477RH	487	487ST	487TC	493	787	787TC	787ST	797	797TC	797ST	811	881

EA

**BSP Swivel Female
with O-Ring (60° Cone)**

BS 5200 – ISO 12151-6 – DKOR

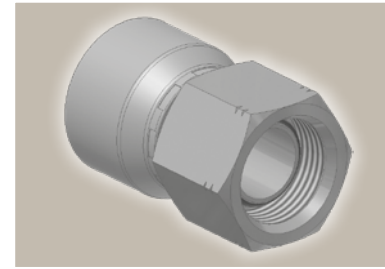
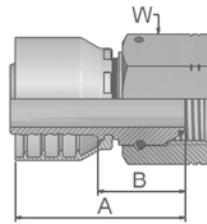

Part Number		Hose I.D.				Thread	A	B	W
46 series	48 series	DN	Inch	Size	mm	BSP	mm	mm	mm
1EA46-4-4	1EA48-4-4	6	1/4	-4	6.4	1/4x19	40	17	19
1EA46-6-4	1EA48-6-4	6	1/4	-4	6.4	3/8x19	49	26	22
	1EA48-6-5	8	5/16	-5	7.9	3/8x19	50	25	22
	1EA48-4-6	10	3/8	-6	9.5	1/4x19	44	21	19
1EA46-6-6	1EA48-6-6	10	3/8	-6	9.5	3/8x19	43	20	22
1EA46-8-6	1EA48-8-6	10	3/8	-6	9.5	1/2x14	51	28	27
	1EA48-6-8	12	1/2	-8	12.7	3/8x19	46	22	22
1EA46-8-8	1EA48-8-8	12	1/2	-8	12.7	1/2x14	45	22	27
	1EA48-10-8	12	1/2	-8	12.7	5/8x14	43	20	30
1EA46-10-10	1EA48-10-10	16	5/8	-10	15.9	5/8x14	46	21	30
1EA46-12-10	1EA48-12-10	16	5/8	-10	15.9	3/4x14	54	29	32
1EA46-12-12	1EA48-12-12	19	3/4	-12	19.1	3/4x14	49	23	32
1EA46-16-12	1EA48-16-12	19	3/4	-12	19.1	1x11	61	35	41
1EA46-16-16	1EA48-16-16	25	1	-16	25.4	1x11	61	31	41
	1EA48-20-20	31	1 1/4	-20	31.8	1 1/4x11	78	31	50
	1EA48-24-24	38	1 1/2	-24	38.1	1 1/2x11	72	34	55

Hose fittings are delivered with ozone resistant Nitrile (NBR) O-ring as a standard version. Working temperature from -40 °C up to +105 °C.
Hose fittings with special O-rings (Viton or EPDM) available on request. O-ring dimensions and part-numbers see in section Eb.

Approved **fitting series** for **hose types**, depending on size: Also available in stainless steel. Details can be found in CAT 4400.1/UK

46 or 48	441	461LT	462	462TC	462ST	629PU	692PU Twin										
46	463	492	492ST	492TC	692	692Twin	692TC	BCH1									
48	301SN	304	387	387ST	387TC	421RH	421SN	426	421TC	436	441RH	462PU	462PU Twin	BCH2	HT2	...	
	471TC	477	477ST	477TC	477RH	487	487ST	487TC	493	787	787TC	787ST	797	797TC	797ST	811	881

EB **BSP Swivel Female
with O-Ring
45° Elbow (60° Cone)**

BS 5200 – ISO 12151-6 – DKOR 45°

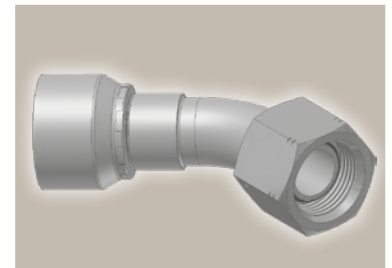
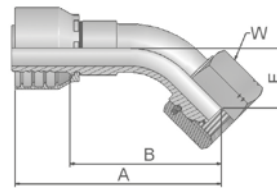

Part Number		Hose I.D.				Thread	A	B	E	W
46 series	48 series	DN	Inch	Size	mm	BSP	mm	mm	mm	mm
1EB46-4-4		6	1/4	-4	6.4	1/4x19	59	36	14	19
	1EB48-4-4	6	1/4	-4	6.4	1/4x19	57	34	14	19
1EB46-6-6	1EB48-6-6	10	3/8	-6	9.5	3/8x19	69	46	17	22
1EB46-8-8	1EB48-8-8	12	1/2	-8	12.7	1/2x14	71	48	20	27
1EB46-12-10	1EB48-12-10	16	5/8	-10	15.9	3/4x14	78	52	21	32
1EB46-12-12	1EB48-12-12	19	3/4	-12	19.1	3/4x14	89	63	27	32
1EB46-16-16	1EB48-16-16	25	1	-16	25.4	1x11	112	82	33	41
	1EB48-20-20	31	1 1/4	-20	31.8	1 1/4x11	138	91	35	50
	1EB48-24-24	38	1 1/2	-24	38.1	1 1/2x11	157	119	50	55

Hose fittings are delivered with ozone resistant Nitrile (NBR) O-ring as a standard version. Working temperature from -40 °C up to +105 °C.
Hose fittings with special O-rings (Viton or EPDM) available on request. O-ring dimensions and part-numbers see in section Eb.

Approved **fitting series** for hose types, depending on size: Also available in stainless steel. Details can be found in CAT 4400.1/UK

46 or 48	441	461LT	462	462TC	462ST	629PU	692PU Twin										
46	463	492	492ST	492TC	692	692Twin	692TC	BCH1									
48	301SN	304	387	387ST	387TC	421RH	421SN	426	421TC	436	441RH	462PU	462PU Twin	BCH2	HT2	...	
	471TC	477	477ST	477TC	477RH	487	487ST	487TC	493	787	787TC	787ST	797	797TC	797ST	811	881

EC **BSP Swivel Female
with O-Ring
90° Elbow (60° Cone)**

BS 5200 – ISO 12151-6 – DKOR 90°

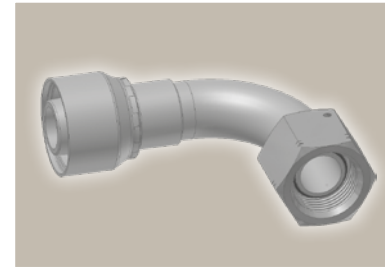
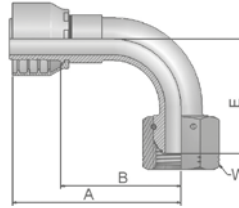

Part Number		Hose I.D.				Thread	A	B	E	W
46 series	48 series	DN	Inch	Size	mm	BSP	mm	mm	mm	mm
1EC46-4-4	1EC48-4-4	6	1/4	-4	6.4	1/4x19	50	27	24	19
1EC46-6-4	1EC48-6-4	6	1/4	-4	6.4	3/8x19	51	28	27	22
1EC46-6-6	1EC48-6-6	10	3/8	-6	9.5	3/8x19	60	38	33	22
1EC46-8-6	1EC48-8-6	10	3/8	-6	9.5	1/2x14	60	38	36	27
	1EC48-6-8	12	1/2	-8	12.7	3/8x19	63	39	41	22
1EC46-8-8	1EC48-8-8	12	1/2	-8	12.7	1/2x14	63	40	40	27
1EC46-10-8	1EC48-10-8	12	1/2	-8	12.7	5/8x14	63	40	39	30
1EC46-10-10	1EC48-10-10	16	5/8	-10	15.9	5/8x14	70	45	44	30
1EC46-12-10		16	5/8	-10	15.9	3/4x14	70	45	42	32
	1EC48-12-10	16	5/8	-10	15.9	5/8x14	70	45	42	32
1EC46-12-12	1EC48-12-12	19	3/4	-12	19.1	3/4x14	79	54	55	32
1EC46-16-12	1EC48-16-12	19	3/4	-12	19.1	1x11	80	54	59	41
1EC46-16-16	1EC48-16-16	25	1	-16	25.4	1x11	105	75	71	41
	1EC48-20-20	31	1 1/4	-20	31.8	1 1/4x11	129	82	75	50
	1EC48-24-24	38	1 1/2	-24	38.1	1 1/2x11	140	102	103	55
	1EC48-32-32	51	2	-32	50.8	2x11	185	137	132	70

Hose fittings are delivered with ozone resistant Nitrile (NBR) O-ring as a standard version. Working temperature from -40 °C up to +105 °C.
Hose fittings with special O-rings (Viton or EPDM) available on request. O-ring dimensions and part-numbers see in section Eb.

Approved **fitting series** for **hose types**, depending on size: Also available in stainless steel. Details can be found in CAT 4400.1/UK

46 or 48	441	461LT	462	462TC	462ST	629PU	692PU Twin										
46	463	492	492ST	492TC	692	692Twin	692TC	BCH1									
48	301SN	304	387	387ST	387TC	421RH	421SN	426	421TC	436	441RH	462PU	462PU Twin	BCH2	HT2	...	
	471TC	477	477ST	477TC	477RH	487	487ST	487TC	493	787	787TC	787ST	797	797TC	797ST	811	881

D9 Male BSP Parallel Pipe Rigid – Straight (60° Cone)

BSP5200 – AGR

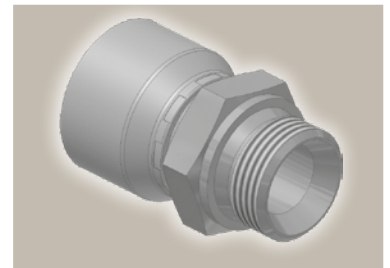
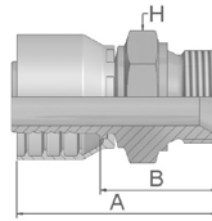

Part Number		Hose I.D.				Thread	A	B	H
46 series	48 series	DN	Inch	Size	mm	BSP	mm	mm	mm
1D946-2-4	1D948-2-4	6	1/4	-4	6.4	1/8x28	46	22	14
1D946-4-4	1D948-4-4	6	1/4	-4	6.4	1/4x19	51	27	19
1D946-6-4	1D948-6-4	6	1/4	-4	6.4	3/8x19	53	31	22
1D946-8-4	1D948-8-4	6	1/4	-4	6.4	1/2x14	54	52	27
1D946-4-5		8	5/16	-5	7.9	1/4x19	50	27	19
	1D948-4-5	8	5/16	-5	7.9	1/4x19	49	27	19
1D946-6-5	1D948-6-5	8	5/16	-5	7.9	3/8x19	55	31	22
1D946-4-6		10	3/8	-6	9.5	1/4x19	49	27	19
	1D948-4-6	10	3/8	-6	9.5	1/4x19	50	27	19
1D946-6-6	1D948-6-6	10	3/8	-6	9.5	3/8x19	54	31	22
1D946-8-6	1D948-8-6	10	3/8	-6	9.5	1/2x14	56	33	27
1D946-6-8	1D948-6-8	12	1/2	-8	12.7	3/8x19	54	30	22
1D946-8-8	1D948-8-8	12	1/2	-8	12.7	1/2x14	57	33	27
1D946-10-8	1D948-10-8	12	1/2	-8	12.7	5/8x14	58	35	30
1D946-12-8	1D948-12-8	12	1/2	-8	12.7	3/4x14	60	36	32
1D946-8-10	1D948-8-10	16	5/8	-10	15.9	1/2x14	58	33	27
1D946-10-10	1D948-10-10	16	5/8	-10	15.9	5/8x14	60	35	30
1D946-12-10	1D948-12-10	16	5/8	-10	15.9	3/4x14	62	37	32
1D946-12-12	1D948-12-12	19	3/4	-12	19.1	3/4x14	62	36	32
1D946-16-12	1D948-16-12	19	3/4	-12	19.1	1x11	67	41	41
1D946-16-16	1D948-16-16	25	1	-16	25.4	1x11	72	42	41
	1D948-20-16	25	1	-16	25.4	1 1/4x11	75	46	50
1D946-20-20		31	1 1/4	-20	31.8	1 1/4x11	85	47	50
	1D948-20-20	31	1 1/4	-20	31.8	1 1/4x11	92	45	50
	1D948-24-24	38	1 1/2	-24	38.1	1 1/2x11	87	49	60
	1D948-32-32	51	2	-32	50.8	2x11	102	54	70

46/48 Series

Approved **fitting series** for hose types, depending on size: Also available in stainless steel. Details can be found in CAT 4400.1/UK

46 or 48	441	461LT	462	462TC	462ST	629PU	692PU Twin										
46	463	492	492ST	492TC	692	692Twin	692TC	BCH1									
48	301SN	304	387	387ST	387TC	421RH	421SN	426	421TC	436	441RH	462PU	462PU Twin	BCH2	HT2	...	
	471TC	477	477ST	477TC	477RH	487	487ST	487TC	493	787	787TC	787ST	797	797TC	797ST	811	881

91 Male BSP Taper Pipe – Rigid Straight

BS5200 – AGR-K

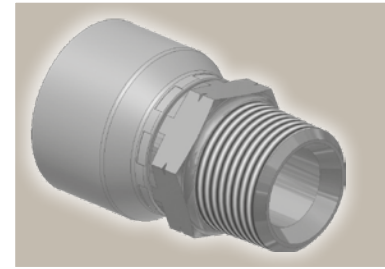
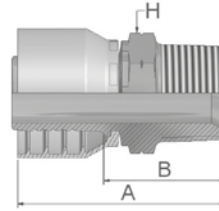

Part Number		Hose I.D.				Thread	A	B	H
46 series	48 series	DN	Inch	Size	mm	BSP	mm	mm	mm
19146-4-4	19148-4-4	6	1/4	-4	6.4	1/4x19	49	26	14
	19148-6-4	6	1/4	-4	6.4	3/8x19	51	28	17
19146-4-5	19148-4-5	8	5/16	-5	7.9	1/4x19	49	25	14
19146-6-5	19148-6-5	8	5/16	-5	7.9	3/8x19	48	24	19
	19148-4-6	10	3/8	-6	9.5	1/4x19	46	24	14
19146-6-6	19148-6-6	10	3/8	-6	9.5	3/8x19	52	27	19
19146-8-6	19148-8-6	10	3/8	-6	9.5	1/2x14	57	34	22
	19148-6-8	12	1/2	-8	12.7	3/8x19	48	25	19
19146-8-8	19148-8-8	12	1/2	-8	12.7	1/2x14	57	33	22
	19148-12-10	16	5/8	-10	15.9	3/4x14	63	37	30
19146-12-12	19148-12-12	19	3/4	-12	19.1	3/4x14	63	37	30
19146-16-16	19148-16-16	25	1	-16	25.4	1x11	72	42	36

B5 Female BSP Parallel Pipe Swivel Straight (Flat Seat)

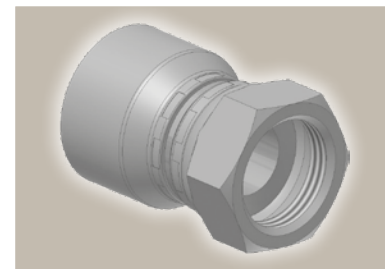
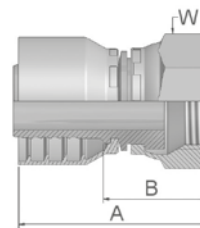

Part Number		Hose I.D.				Thread	A	B	W
46 series	48 series	DN	Inch	Size	mm	BSP	mm	mm	mm
1B546-4-4	1B548-4-4	6	1/4	-4	6.4	1/4x19	41	17	19
1B546-4-5	1B548-4-5	8	5/16	-5	7.9	1/4x19	41	17	19
1B546-6-5	1B548-6-5	8	5/16	-5	7.9	3/8x19	38	14	22
1B546-8-5	1B548-8-5	8	5/16	-5	7.9	1/2x14	44	21	27
1B546-6-6	1B548-6-6	10	3/8	-6	9.5	3/8x19	37	14	22
1B546-8-6	1B548-8-6	10	3/8	-6	9.5	1/2x14	43	20	27
1B546-8-8	1B548-8-8	12	1/2	-8	12.7	1/2x14	43	19	27
1B546-12-8	1B548-12-8	12	1/2	-8	12.7	3/4x14	43	19	32
1B546-12-10	1B548-12-10	16	5/8	-10	15.9	3/4x14	43	18	32
1B546-12-12	1B548-12-12	19	3/4	-12	19.1	3/4x14	44	18	32
1B546-16-16	1B548-16-16	25	1	-16	25.4	1x11	51	21	41

Approved fitting series for hose types, depending on size: Also available in stainless steel. Details can be found in CAT 4400.1/UK

46 or 48	441	461LT	462	462TC	462ST	629PU	692PU Twin										
46	463	492	492ST	492TC	692	692Twin	692TC	BCH1									
48	301SN	304	387	387ST	387TC	421RH	421SN	426	421TC	436	441RH	462PU	462PU Twin	BCH2	HT2	...	
	471TC	477	477ST	477TC	477RH	487	487ST	487TC	493	787	787TC	787ST	797	797TC	797ST	811	881

01

Male NPTF Pipe Rigid – Straight

SAE J476A/ J516 – AGN

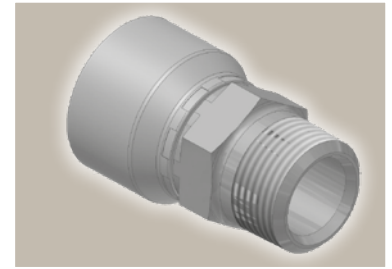
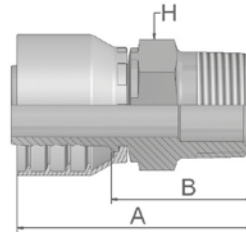

Part Number		Hose I.D.				Thread	A	B	H
46 series	48 series	DN	Inch	Size	mm	NPTF	mm	mm	mm
10146-2-4	10148-2-4	6	1/4	-4	6.4	1/8-27	48	24	12
10146-4-4	10148-4-4	6	1/4	-4	6.4	1/4-18	53	29	14
10146-6-4	10148-6-4	6	1/4	-4	6.4	3/8-18	55	31	19
10146-4-5	10148-4-5	8	5/16	-5	7.9	1/4-18	53	29	14
10146-6-5	10148-6-5	8	5/16	-5	7.9	3/8-18	55	31	19
10146-4-6	10148-4-6	10	3/8	-6	9.5	1/4-18	52	29	14
10146-6-6	10148-6-6	10	3/8	-6	9.5	3/8-18	54	31	19
10146-8-6	10148-8-6	10	3/8	-6	9.5	1/2-14	55	32	22
10146-6-8	10148-6-8	12	1/2	-8	12.7	3/8-18	55	32	19
10146-8-8	10148-8-8	12	1/2	-8	12.7	1/2-14	61	38	22
10146-8-10	10148-8-10	16	5/8	-10	15.9	1/2-14	63	38	22
10146-12-10	10148-12-10	16	5/8	-10	15.9	3/4-14	59	34	27
10146-12-12	10148-12-12	19	3/4	-12	19.1	3/4-14	60	34	27
10146-16-16	10148-16-16	25	1	-16	25.4	1-11 1/2	75	45	36
10146-20-20		31	1 1/4	-20	31.8	1 1/4-11 1/2	86	48	46
	10148-20-20	31	1 1/4	-20	31.8	1 1/4-11 1/2	104	57	46
	10148-24-24	38	1 1/2	-24	38.1	1 1/2-11 1/2	89	51	50
	10148-32-32	51	2	-32	50.8	2-11 1/2	104	55	65

46/48 Series

Approved **fitting series** for hose types, depending on size: Also available in stainless steel. Details can be found in CAT 4400.1/UK

46 or 48	441	461LT	462	462TC	462ST	629PU	692PU Twin										
46	463	492	492ST	492TC	692	692Twin	692TC	BCH1									
48	301SN	304	387	387ST	387TC	421RH	421SN	426	421TC	436	441RH	462PU	462PU Twin	BCH2	HT2	...	
	471TC	477	477ST	477TC	477RH	487	487ST	487TC	493	787	787TC	787ST	797	797TC	797ST	811	881

03 Male JIC 37° – Rigid Straight

ISO12151-5-S – AGJ

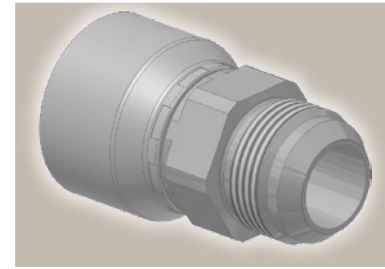
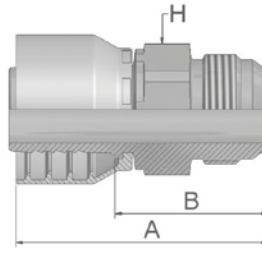

Part Number		Hose I.D.				Thread	A	B	H
46 series	48 series	DN	Inch	Size	mm	UNF	mm	mm	mm
10346-4-4	10348-4-4	6	1/4	-4	6.4	7/16x20	52	29	14
10346-5-4	10348-5-4	6	1/4	-4	6.4	1/2x20	52	29	14
10346-6-4	10348-6-4	6	1/4	-4	6.4	9/16x18	55	31	19
10346-5-5	10348-5-5	8	5/16	-5	7.9	1/2x20	50	26	14
10346-6-5	10348-6-5	8	5/16	-5	7.9	9/16x18	55	31	19
10346-8-5	10348-8-5	8	5/16	-5	7.9	3/4x16	57	33	19
10346-4-6	10348-4-6	10	3/8	-6	9.5	7/16x20	54	31	19
10346-5-6	10348-5-6	10	3/8	-6	9.5	1/2x20	53	30	19
10346-6-6	10348-6-6	10	3/8	-6	9.5	9/16x18	56	31	19
10346-8-6	10348-8-6	10	3/8	-6	9.5	3/4x16	53	30	22
10346-10-6	10348-10-6	10	3/8	-6	9.5	7/8x14	56	33	24
10346-8-8	10348-8-8	12	1/2	-8	12.7	3/4x16	57	34	22
10346-10-8	10348-10-8	12	1/2	-8	12.7	7/8x14	56	32	24
10346-12-8	10348-12-8	12	1/2	-8	12.7	1 1/16x12	62	38	27
10346-10-10	10348-10-10	16	5/8	-10	15.9	7/8x14	63	38	24
10346-12-10	10348-12-10	16	5/8	-10	15.9	1 1/16x12	64	39	27
10346-12-12	10348-12-12	19	3/4	-12	19.1	1 1/16x12	68	42	27
10346-14-12	10348-14-12	19	3/4	-12	19.1	1 3/16x12	68	42	30
10346-16-12	10348-16-12	19	3/4	-12	19.1	1 5/16x12	64	38	36
10346-16-16	10348-16-16	25	1	-16	25.4	1 5/16x12	76	46	36
10346-20-16	10348-20-16	25	1	-16	25.4	1 5/8x12	73	43	46
10346-20-20		31	1 1/4	-20	31.8	1 5/8x12	86	48	46
	10348-20-20	31	1 1/4	-20	31.8	1 5/8x12	101	53	46
	10348-24-24	38	1 1/2	-24	38.1	1 7/8x12	85	47	50
	10348-32-32	51	2	-32	50.8	2 1/2x12	109	61	65

Approved fitting series for hose types, depending on size: Also available in stainless steel. Details can be found in CAT 4400.1/UK

46 or 48	441	461LT	462	462TC	462ST	629PU	692PU Twin										
46	463	492	492ST	492TC	692	692Twin	692TC	BCH1									
48	301SN	304	387	387ST	387TC	421RH	421SN	426	421TC	436	441RH	462PU	462PU Twin	BCH2	HT2	...	
	471TC	477	477ST	477TC	477RH	487	487ST	487TC	493	787	787TC	787ST	797	797TC	797ST	811	881

**06/68 Female – JIC 37°
SAE 45° Dual Flare
Swivel – Straight**
ISO12151-5-SWS – DKJ

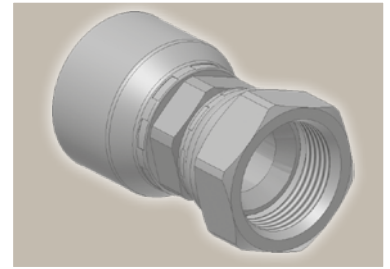
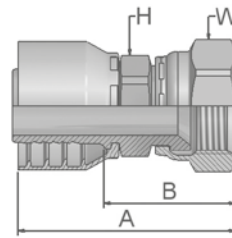

Part Number		Hose I.D.				Thread	A	B	H	W
46 series	48 series	DN	Inch	Size	mm	UNF	mm	mm	mm	mm
16846-4-4	16848-4-4	6	1/4	-4	6.4	7/16x20	52	29	14	17
16846-5-4		6	1/4	-4	6.4	1/2x20	53	30	14	17
	16848-5-4	6	1/4	-4	6.4	1/2x20	54	30	14	17
10646-6-4	10648-6-4	6	1/4	-4	6.4	9/16x18	55	31	14	19
16846-5-5		8	5/16	-5	7.9	1/2x20	54	31	14	17
	16848-5-5	8	5/16	-5	7.9	1/2x20	54	30	14	17
10646-6-5	10648-6-5	8	5/16	-5	7.9	9/16x18	53	29	14	19
16846-8-5	16848-8-5	8	5/16	-5	7.9	3/4x16	57	34	17	22
16846-4-6	16848-4-6	10	3/8	-6	9.5	7/16x20	50	27	14	17
16846-5-6		10	3/8	-6	9.5	1/2x20	51	29	14	17
	16848-5-6	10	3/8	-6	9.5	1/2x20	52	29	14	17
10646-6-6	10648-6-6	10	3/8	-6	9.5	9/16x18	52	30	17	19
16846-8-6	16848-8-6	10	3/8	-6	9.5	3/4x16	56	34	17	22
16846-10-6	16848-10-6	10	3/8	-6	9.5	7/8x14	59	36	22	27
10646-6-8	10648-6-8	12	1/2	-8	12.7	9/16x18	55	32	22	19
16846-8-8	16848-8-8	12	1/2	-8	12.7	3/4x16	56	32	22	22
16846-10-8	16848-10-8	12	1/2	-8	12.7	7/8x14	62	38	22	27
10646-12-8	10648-12-8	12	1/2	-8	12.7	1 1/16x12	62	39	27	32
16846-8-10	16848-8-10	16	5/8	-10	15.9	3/4x16	57	32	22	22
16846-10-10	16848-10-10	16	5/8	-10	15.9	7/8x14	60	35	22	27
10646-12-10	10648-12-10	16	5/8	-10	15.9	1 1/16x12	64	39	27	32
16846-8-12	16848-8-12	19	3/4	-12	19.1	3/4x16	58	32	24	22
16846-10-12	16848-10-12	19	3/4	-12	19.1	7/8x14	61	35	24	27
10646-12-12	10648-12-12	19	3/4	-12	19.1	1 1/16x12	67	41	27	32
10646-14-12	10648-14-12	19	3/4	-12	19.1	1 3/16x12	68	42	30	36
10646-16-12	10648-16-12	19	3/4	-12	19.1	1 5/16x12	71	45	32	41
10646-12-16	10648-12-16	25	1	-16	25.4	1 1/16x12	73	44	32	32
10646-16-16	10648-16-16	25	1	-16	25.4	1 5/16x12	75	46	32	41
10646-20-16	10648-20-16	25	1	-16	25.4	1 5/8x12	80	50	41	50
10646-16-20		31	1 1/4	-20	31.8	1 5/16x12	87	49	41	41
	10648-16-20	31	1 1/4	-20	31.8	1 5/16x12	97	50	46	41
10646-20-20		31	1 1/4	-20	31.8	1 5/8x12	89	51	46	50
	10648-20-20	31	1 1/4	-20	31.8	1 5/8x12	100	53	46	50
	10648-24-24	38	1 1/2	-24	38.1	1 7/8x12	98	60	55	60
	10648-32-32	51	2	-32	50.8	2 1/2x12	120	72	65	75

46/48 Series

Approved **fitting series** for hose types, depending on size: Also available in stainless steel. Details can be found in CAT 4400.1/UK

46 or 48	441	461LT	462	462TC	462ST	629PU	692PU Twin										
46	463	492	492ST	492TC	692	692Twin	692TC	BCH1									
48	301SN	304	387	387ST	387TC	421RH	421SN	426	421TC	436	441RH	462PU	462PU Twin	BCH2	HT2	...	
	471TC	477	477ST	477TC	477RH	487	487ST	487TC	493	787	787TC	787ST	797	797TC	797ST	811	881

08 Female SAE 45° – Swivel Straight

SAE J516

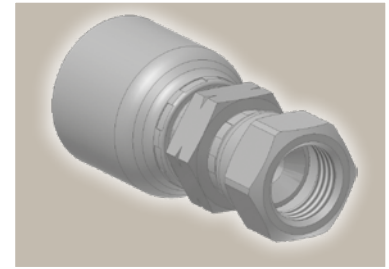
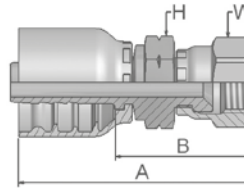

Part Number		Hose I.D.				Thread	A	B	H	W
46 series	48 series	DN	Inch	Size	mm	UNF	mm	mm	mm	mm
	10848-6-6	10	3/8	-6	9.5	5/8x18	57		34	19

37/3V Female JIC 37° SAE 45° – Dual Flare Swivel Female 45° Elbow

ISO 12151-5-SWE 45° – DKJ 45°

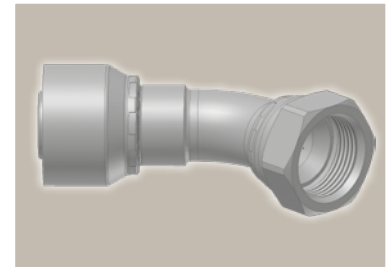
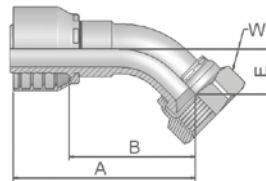

Part Number		Hose I.D.				Thread	A	B	E	W
46 series	48 series	DN	Inch	Size	mm	UNF	mm	mm	mm	mm
13V46-4-4	13V48-4-4	6	1/4	-4	6.4	7/16x20	53	29	10	17
13V46-5-4	13V48-5-4	6	1/4	-4	6.4	1/2x20	57	33	9	17
13746-6-4	13748-6-4	6	1/4	-4	6.4	9/16x18	55	31	11	19
13V46-5-5	13V48-5-5	8	5/16	-5	7.9	1/2x20	53	29	10	17
13746-6-5	13748-6-5	8	5/16	-5	7.9	9/16x18	58	35	10	19
13746-6-6	13748-6-6	10	3/8	-6	9.5	9/16x18	60	37	11	19
13V46-8-6	13V48-8-6	10	3/8	-6	9.5	3/4x16	67	44	15	22
13V46-10-6	13V48-10-6	10	3/8	-6	9.5	7/8 14	69	46	17	27
13V46-8-8	13V48-8-8	12	1/2	-8	12.7	3/4x16	61	37	15	22
13V46-10-8	13V48-10-8	12	1/2	-8	12.7	7/8x14	70	46	16	27
13V46-10-10	13V48-10-10	16	5/8	-10	15.9	7/8x14	69	44	16	27
13746-12-10	13748-12-10	16	5/8	-10	15.9	1 1/16x12	74	49	21	32
13746-12-12	13748-12-12	19	3/4	-12	19.1	1 1/16x12	83	58	22	32
13746-14-12	13748-14-12	19	3/4	-12	19.1	1 3/16x12	84	58	22	36
13746-16-12	13748-16-12	19	3/4	-12	19.1	1 5/16x12	84	58	24	41
13746-12-16	13748-12-16	25	1	-16	25.4	1 1/16x12	91	61	21	32
13746-16-16	13748-16-16	25	1	-16	25.4	1 5/16x12	99	70	24	41
13746-20-16	13748-20-16	25	1	-16	25.4	1 5/8x12	101	71	26	50
13746-20-20		31	1 1/4	-20	31.8	1 5/8x12	129	91	31	50
	13748-20-20	31	1 1/4	-20	31.8	1 5/8x12	134	87	30	50
	13748-24-24	38	1 1/2	-24	38.1	1 7/8x12	165	127	58	60

Approved **fitting series** for **hose types**, depending on size: Also available in stainless steel. Details can be found in CAT 4400.1/UK

46 or 48	441	461LT	462	462TC	462ST	629PU	692PU Twin										
46	463	492	492ST	492TC	692	692Twin	692TC	BCH1									
48	301SN	304	387	387ST	387TC	421RH	421SN	426	421TC	436	441RH	462PU	462PU Twin	BCH2	HT2	...	
	471TC	477	477ST	477TC	477RH	487	487ST	487TC	493	787	787TC	787ST	797	797TC	797ST	811	881

39/3W Female JIC 37°
SAE 45° – Dual Flare
Swivel Female 90° Elbow
ISO 12151-5-SWES – DKJ 90°

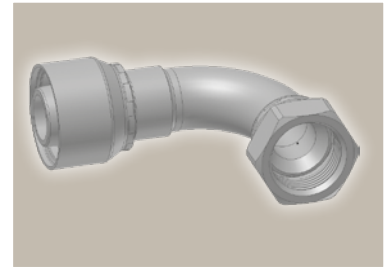
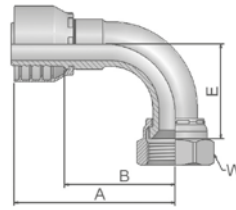

Part Number		Hose I.D.				Thread	A	B	E	W
46 series	48 series	DN	Inch	Size	mm	UNF	mm	mm	mm	mm
13W46-4-4	13W48-4-4	6	1/4	-4	6.4	7/16x20	48	24	21	17
13W46-5-4	13W48-5-4	6	1/4	-4	6.4	1/2x20	57	34	21	17
13946-6-4	13948-6-4	6	1/4	-4	6.4	9/16x18	49	25	23	19
13W46-5-5	13W48-5-5	8	5/16	-5	7.9	1/2x20	49	25	21	17
13946-6-5	13948-6-5	8	5/16	-5	7.9	9/16x18	51	28	23	19
13W46-4-6	13W48-4-6	10	3/8	-6	9.5	7/16x20	46	23	21	17
13946-6-6	13948-6-6	10	3/8	-6	9.5	9/16x18	51	28	23	19
13W46-8-6	13W48-8-6	10	3/8	-6	9.5	3/4x16	59	36	29	22
13W46-10-6	13W48-10-6	10	3/8	-6	9.5	7/8x14	61	38	32	27
13946-6-8	13948-6-8	12	1/2	-8	12.7	9/16x18	54	30	23	19
13W46-8-8	13W48-8-8	12	1/2	-8	12.7	3/4x16	55	31	29	22
13W46-10-8	13W48-10-8	12	1/2	-8	12.7	7/8x14	63	39	32	27
13W46-10-10	13W48-10-10	16	5/8	-10	15.9	7/8x14	64	39	33	27
13946-12-10	13948-12-10	16	5/8	-10	15.9	1 1/16x12	74	49	48	32
13946-12-12	13948-12-12	19	3/4	-12	19.1	1 1/16x12	80	54	48	32
13946-14-12	13948-14-12	19	3/4	-12	19.1	1 3/16x12	80	54	51	36
13946-16-12	13948-16-12	19	3/4	-12	19.1	1 5/16x12	80	54	56	41
13946-12-16	13948-12-16	25	1	-16	25.4	1 1/16x12	87	58	48	32
13946-16-16	13948-16-16	25	1	-16	25.4	1 5/16x12	98	68	56	41
13946-20-16	13948-20-16	25	1	-16	25.4	1 5/8x12	98	68	62	50
13946-20-20		31	1 1/4	-20	31.8	1 5/8x12	124	86	70	50
	13948-20-20	31	1 1/4	-20	31.8	1 5/8x12	129	82	70	50
	13948-24-24	38	1 1/2	-24	38.1	1 7/8x12	140	102	91	60

46/48 Series

Approved **fitting series** for hose types, depending on size: Also available in stainless steel. Details can be found in CAT 4400.1/UK

46 or 48	441	461LT	462	462TC	462ST	629PU	692PU Twin										
46	463	492	492ST	492TC	692	692Twin	692TC	BCH1									
48	301SN	304	387	387ST	387TC	421RH	421SN	426	421TC	436	441RH	462PU	462PU Twin	BCH2	HT2	...	
	471TC	477	477ST	477TC	477RH	487	487ST	487TC	493	787	787TC	787ST	797	797TC	797ST	811	881

41/3Y Female JIC 37° / 45° Swivel Female 90° Elbow (Long)

ISO 12151-5-SWEL – DKJ 90°L

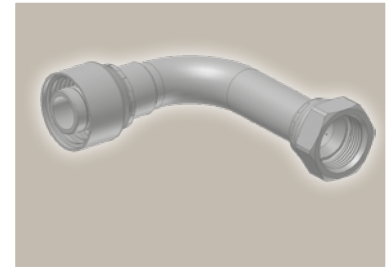
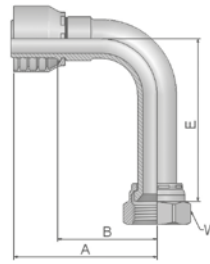

Part Number		Hose I.D.				Thread	A	B	E	W
46 series	48 series	DN	Inch	Size	mm	UNF	mm	mm	mm	mm
13Y46-4-4	13Y48-4-4	6	1/4	-4	6.4	7/16x20	61	37	46	17
14146-6-4	14148-6-4	6	1/4	-4	6.4	9/16x18	57	34	55	19
14146-6-6	14148-6-6	10	3/8	-6	9.5	9/16x18	57	34	54	19
13Y46-8-6		10	3/8	-6	9.5	3/4x16	59	36.5	62	22
	13Y48-8-6	10	3/8	-6	9.5	3/4x16	55	32	62	22
13Y46-8-8	13Y48-8-8	12	1/2	-8	12.7	3/4x16	59	36	64	22
13Y46-10-10	13Y48-10-10	16	5/8	-10	15.9	7/8x14	61	36	70	27
14146-12-12	14148-12-12	19	3/4	-12	19.1	1 1/16x12	80	54	96	32
14146-16-16	14148-16-16	25	1	-16	25.4	1 5/16x12	98	68	110	41

Approved **fitting series** for **hose types**, depending on size: Also available in stainless steel. Details can be found in CAT 4400.1/UK

46 or 48	441	461LT	462	462TC	462ST	629PU	692PU Twin										
46	463	492	492ST	492TC	692	692Twin	692TC	BCH1									
48	301SN	304	387	387ST	387TC	421RH	421SN	426	421TC	436	441RH	462PU	462PU Twin	BCH2	HT2	...	
	471TC	477	477ST	477TC	477RH	487	487ST	487TC	493	787	787TC	787ST	797	797TC	797ST	811	881

15 ISO 6162-1-Flange Straight

ISO 12151-3-S-L – SFL
(21.0 MPa/ 3000 psi)

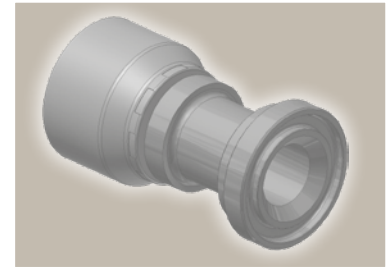
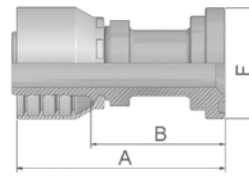

Part Number		Hose I.D.				Flange	A	B	F
46 series	48 series	DN	Inch	Size	mm	Inch	mm	mm	mm
11546-8-8	11548-8-8	12	1/2	-8	12.7	1/2	74	50	30
11546-12-8	11548-12-8	12	1/2	-8	12.7	3/4	51	27	38
11546-12-10	11548-12-10	16	5/8	-10	15.9	3/4	55	30	38
11546-12-12	11548-12-12	19	3/4	-12	19.1	3/4	81	55	38
11546-16-12	11548-16-12	19	3/4	-12	19.1	1	56	30	45
11546-20-12	11548-20-12	19	3/4	-12	19.1	1 1/4	77	51	51
11546-16-16	11548-16-16	25	1	-16	25.4	1	84	54	45
11546-20-16	11548-20-16	25	1	-16	25.4	1 1/4	65	35	51
11546-24-16	11548-24-16	25	1	-16	25.4	1 1/2	97	67	60
	11548-16-20	31	1 1/4	-20	31.8	1	111	64	45
11546-20-20		31	1 1/4	-20	31.8	1 1/4	114	76	51
	11548-20-20	31	1 1/4	-20	31.8	1 1/4	119	72	51
11546-24-20		31	1 1/4	-20	31.8	1 1/2	72	35	60
	11548-24-20	31	1 1/4	-20	31.8	1 1/2	82	35	60
	11548-32-20	31	1 1/4	-20	31.8	2	123	76	71
	11548-24-24	38	1 1/2	-24	38.1	1 1/2	117	79	60
	11548-32-24	38	1 1/2	-24	38.1	2	80	42	71
	11548-24-32	51	2	-32	50.8	1 1/2	129	81	60
	11548-32-32	51	2	-32	50.8	2	127	79	71

To select corresponding half-flange and O-ring see section Eb.

46/48 Series

Approved **fitting series** for hose types, depending on size: Also available in stainless steel. Details can be found in CAT 4400.1/UK

46 or 48	441	461LT	462	462TC	462ST	629PU	692PU Twin										
46	463	492	492ST	492TC	692	692Twin	692TC	BCH1									
48	301SN	304	387	387ST	387TC	421RH	421SN	426	421TC	436	441RH	462PU	462PU Twin	BCH2	HT2	...	
	471TC	477	477ST	477TC	477RH	487	487ST	487TC	493	787	787TC	787ST	797	797TC	797ST	811	881

17 ISO 6162-1 Flange 45° Elbow

ISO 12151-3 – E45 – L – SFL 45°
(21.0 MPa/ 3000 psi)

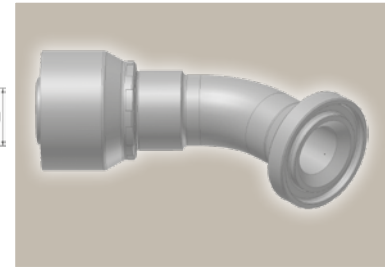
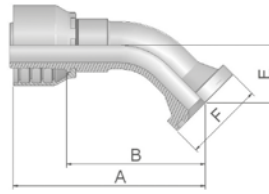

Part Number		Hose I.D.				Flange	A	B	E	F
46 series	48 series	DN	Inch	Size	mm	Inch	mm	mm	mm	mm
11746-8-8	11748-8-8	12	1/2	-8	12.7	1/2	72	48	20	30
11746-12-8	11748-12-8	12	1/2	-8	12.7	3/4	70	47	21	38
11746-12-10	11748-12-10	16	5/8	-10	15.9	3/4	75	50	24	38
11746-12-12	11748-12-12	19	3/4	-12	19.1	3/4	88	62	26	38
11746-16-12	11748-16-12	19	3/4	-12	19.1	1	88	62	26	45
11746-20-12	11748-20-12	19	3/4	-12	19.1	1 1/4	87	61	25	51
11746-16-16		25	1	-16	25.4	1	109	78	32	45
	11748-16-16	25	1	-16	25.4	1	107	78	32	45
11746-20-16	11748-20-16	25	1	-16	25.4	1 1/4	109	79	32	51
	11748-16-20	31	1 1/4	-20	31.8	1	141	94	38	45
11746-20-20		31	1 1/4	-20	31.8	1 1/4	136	98	38	51
	11748-20-20	31	1 1/4	-20	31.8	1 1/4	141	94	38	51
11746-24-20		31	1 1/4	-20	31.8	1 1/2	136	98	38	60
	11748-24-20	31	1 1/4	-20	31.8	1 1/2	141	94	38	60
	11748-24-24	38	1 1/2	-24	38.1	1 1/2	151	113	44	60
	11748-32-24	38	1 1/2	-24	38.1	2	150	112	44	71
	11748-24-32	51	2	-32	50.8	1 1/2	164	115	44	60
	11748-32-32	51	2	-32	50.8	2	202	153	56	71

To select corresponding half-flange and O-ring see section Eb.

Approved **fitting series** for **hose types**, depending on size: Also available in stainless steel. Details can be found in CAT 4400.1/UK

46 or 48	441	461LT	462	462TC	462ST	629PU	692PU Twin										
46	463	492	492ST	492TC	692	692Twin	692TC	BCH1									
48	301SN	304	387	387ST	387TC	421RH	421SN	426	421TC	436	441RH	462PU	462PU Twin	BCH2	HT2	...	
	471TC	477	477ST	477TC	477RH	487	487ST	487TC	493	787	787TC	787ST	797	797TC	797ST	811	881

19

ISO 6162-1-Flange 90° Elbow

ISO 12151-3 – E-L – SFL 90°
(21.0 MPa/ 3000 psi)

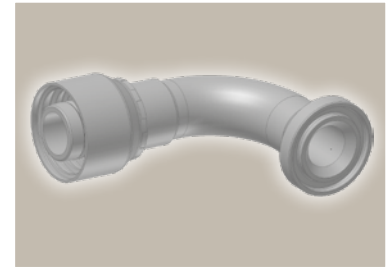
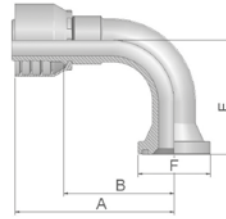

Part Number		Hose I.D.				Flange	A	B	E	F
46 series	48 series	DN	Inch	Size	mm	Inch	mm	mm	mm	mm
11946-8-8	11948-8-8	12	1/2	-8	12.7	1/2	64	41	41	30
11946-12-8	11948-12-8	12	1/2	-8	12.7	3/4	70	47	43	38
11946-12-10	11948-12-10	16	5/8	-10	15.9	3/4	78	53	52	38
11946-16-10	11948-16-10	16	5/8	-10	15.9	1	78	53	53	45
11946-12-12	11948-12-12	19	3/4	-12	19.1	3/4	80	54	58	38
11946-16-12	11948-16-12	19	3/4	-12	19.1	1	80	54	58	45
11946-20-12	11948-20-12	19	3/4	-12	19.1	1 1/4	80	54	54	51
11946-12-16	11948-12-16	25	1	-16	25.4	3/4	98	68	70	38
11946-16-16	11948-16-16	25	1	-16	25.4	1	98	68	70	45
11946-20-16	11948-20-16	25	1	-16	25.4	1 1/4	98	68	69	51
	11948-24-16	25	1	-16	25.4	1 1/2	100	70	62	60
	11948-16-20	31	1 1/4	-20	31.8	1	129	82	90	45
11946-20-20		31	1 1/4	-20	31.8	1 1/4	124	86	90	51
	11948-20-20	31	1 1/4	-20	31.8	1 1/4	130	83	90	51
11946-24-20		31	1 1/4	-20	31.8	1 1/2	124	86	90	60
	11948-24-20	31	1 1/4	-20	31.8	1 1/2	129	82	90	60
	11948-32-20	31	1 1/4	-20	31.8	2	130	83	67	71
	11948-24-24	38	1 1/2	-24	38.1	1 1/2	149	111	104	60
	11948-32-24	38	1 1/2	-24	38.1	2	139	101	104	71
	11948-24-32	51	2	-32	50.8	1 1/2	154	106	104	60
	11948-32-32	51	2	-32	50.8	2	180	132	138	71

To select corresponding half-flange and O-ring see section Eb.

46/48 Series

Approved **fitting series** for hose types, depending on size: Also available in stainless steel. Details can be found in CAT 4400.1/UK

46 or 48	441	461LT	462	462TC	462ST	629PU	692PU Twin										
46	463	492	492ST	492TC	692	692Twin	692TC	BCH1									
48	301SN	304	387	387ST	387TC	421RH	421SN	426	421TC	436	441RH	462PU	462PU Twin	BCH2	HT2	...	
	471TC	477	477ST	477TC	477RH	487	487ST	487TC	493	787	787TC	787ST	797	797TC	797ST	811	881

6A ISO 6162-2-Flange Straight

ISO 12151-3-S-S – SFS
(42.0 MPa/ 6000 psi)

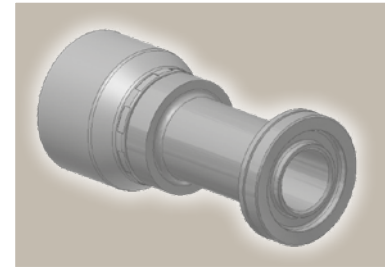
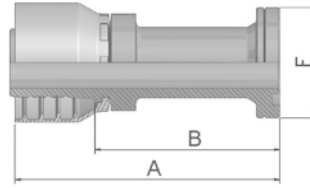

Part Number		Hose I.D.				Flange	A	B	F
46 series	48 series	DN	Inch	Size	mm	Inch	mm	mm	mm
16A46-8-8	16A48-8-8	12	1/2	-8	12.7	1/2	75	51	32
	16A48-12-10	16	5/8	-10	15.9	3/4	60	35	41
16A46-12-12	16A48-12-12	19	3/4	-12	19.1	3/4	96	70	41
16A46-12-16	16A48-12-16	25	1	-16	25.4	3/4	99	69	41
16A46-16-16	16A48-16-16	25	1	-16	25.4	1	111	81	48
16A46-20-20		31	1 1/4	-20	31.8	1 1/4	122	84	54
	16A48-20-20	31	1 1/4	-20	31.8	1 1/4	130	83	54
	16A48-24-24	38	1 1/2	-24	38.1	1 1/2	139	101	64
	16A48-32-32	51	2	-32	50.8	2	172	124	79

To select corresponding half-flange and O-ring see section Eb.

6F ISO 6162-2-Flange 45° Elbow – Heavy Series

ISO 12151-3 – E45-S – SFS 45°
(42.0 MPa/ 6000 psi)

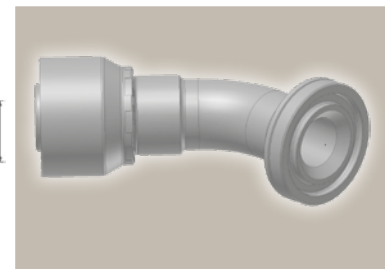
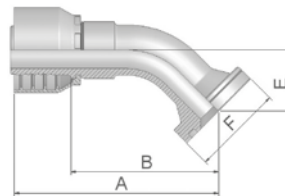

Part Number		Hose I.D.				Flange	A	B	E	F
46 series	48 series	DN	Inch	Size	mm	Inch	mm	mm	mm	mm
16F46-12-12	16F48-12-12	19	3/4	-12	19.1	3/4	88	62	26	41
16F46-16-16	16F48-16-16	25	1	-16	25.4	1	107	78	32	48
	16F48-20-20	31	1 1/4	-20	31.8	1 1/4	141	94	38	54
	16F48-24-24	38	1 1/2	-24	38.1	1 1/2	150	112	44	64
	16F48-32-32	51	2	-32	50.8	2	200	152	56	79

To select corresponding half-flange and O-ring see section Eb.

Approved **fitting series** for **hose types**, depending on size: Also available in stainless steel. Details can be found in CAT 4400.1/UK

46 or 48	441	461LT	462	462TC	462ST	629PU	692PU Twin										
46	463	492	492ST	492TC	692	692Twin	692TC	BCH1									
48	301SN	304	387	387ST	387TC	421RH	421SN	426	421TC	436	441RH	462PU	462PU Twin	BCH2	HT2	...	
	471TC	477	477ST	477TC	477RH	487	487ST	487TC	493	787	787TC	787ST	797	797TC	797ST	811	881

6N ISO 6162-2-Flange 90° Elbow

ISO 12151-3 – E-S – SFS 90°
(42.0 MPa/ 6000 psi)

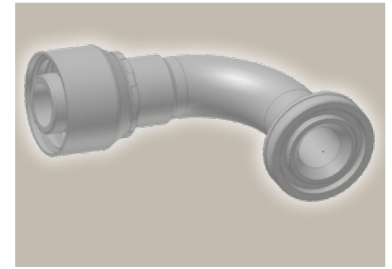
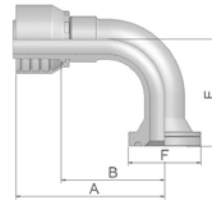

Part Number		Hose I.D.				Flange	A	B	E	F
46 series	48 series	DN	Inch	Size	mm	Inch	mm	mm	mm	mm
16N46-8-12	16N48-8-12	19	3/4	-12	19.1	1/2	70	44	40	32
16N46-12-12	16N48-12-12	19	3/4	-12	19.1	3/4	80	54	54	41
16N46-16-12	16N48-16-12	19	3/4	-12	19.1	1	80	54	53	48
16N46-12-16	16N48-12-16	25	1	-16	25.4	3/4	88	58	70	41
16N46-16-16	16N48-16-16	25	1	-16	25.4	1	98	68	70	48
16N46-20-20		31	1 1/4	-20	31.8	1 1/4	124	86	90	54
	16N48-20-20	31	1 1/4	-20	31.8	1 1/4	129	82	90	54
	16N48-24-24	38	1 1/2	-24	38.1	1 1/2	139	101	104	64
	16N48-32-32	51	2	-32	50.8	2	186	138	138	79

To select corresponding half-flange and O-ring see section Eb.

Approved **fitting series** for hose types, depending on size: Also available in stainless steel. Details can be found in CAT 4400.1/UK

46 or 48	441	461LT	462	462TC	462ST	629PU	692PU Twin										
46	463	492	492ST	492TC	692	692Twin	692TC	BCH1									
48	301SN	304	387	387ST	387TC	421RH	421SN	426	421TC	436	441RH	462PU	462PU Twin	BCH2	HT2	...	
	471TC	477	477ST	477TC	477RH	487	487ST	487TC	493	787	787TC	787ST	797	797TC	797ST	811	881

JC Female ORFS Swivel – Straight Short

ISO 12151-1 – SWSA
SAE J516 – ORFS

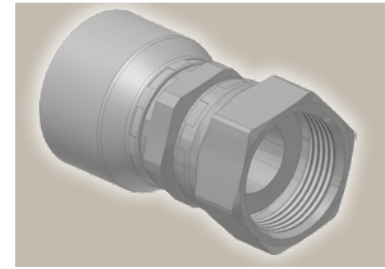
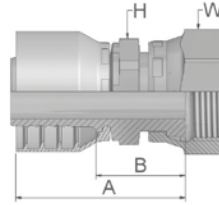

Part Number		Hose I.D.				Thread	A	B	H	W
46 series	48 series	DN	Inch	Size	mm	UNF	mm	mm	mm	mm
1JC46-4-4	1JC48-4-4	6	1/4	-4	6.4	9/16x18	46	22	14	17
1JC46-6-4	1JC48-6-4	6	1/4	-4	6.4	11/16x16	45	23	17	22
1JC46-8-4	1JC48-8-4	6	1/4	-4	6.4	13/16x16	45	22	19	24
1JC46-6-5	1JC48-6-5	8	5/16	-5	7.9	11/16x16	47	23	17	22
1JC46-4-6	1JC48-4-6	10	3/8	-6	9.5	9/16x18	42	19	17	17
1JC46-6-6	1JC48-6-6	10	3/8	-6	9.5	11/16x16	43	21	17	22
1JC46-8-6	1JC48-8-6	10	3/8	-6	9.5	13/16x16	45	22	19	24
1JC46-6-8	1JC48-6-8	12	1/2	-8	12.7	11/16x16	44	20	17	22
1JC46-8-8	1JC48-8-8	12	1/2	-8	12.7	13/16x16	46	22	22	24
1JC46-10-8	1JC48-10-8	12	1/2	-8	12.7	1x14	48	24	24	30
1JC46-12-8	1JC48-12-8	12	1/2	-8	12.7	1 3/16x12	52	29	30	36
1JC46-8-10	1JC48-8-10	16	5/8	-10	15.9	13/16x16	47	22	22	24
1JC46-10-10	1JC48-10-10	16	5/8	-10	15.9	1x14	51	26	24	30
1JC46-12-10	1JC48-12-10	16	5/8	-10	15.9	1 3/16x12	54	28	30	36
1JC46-10-12	1JC48-10-12	19	3/4	-12	19.1	1x14	54	28	24	30
1JC46-12-12	1JC48-12-12	19	3/4	-12	19.1	1 3/16x12	55	29	30	36
1JC46-16-12	1JC48-16-12	19	3/4	-12	19.1	1 7/16x12	59	33	36	41
	1JC48-12-16	25	1	-16	25.4	1 3/16x12	60	30	32	36
1JC46-16-16	1JC48-16-16	25	1	-16	25.4	1 7/16x12	63	33	36	41
1JC46-20-16	1JC48-20-16	25	1	-16	25.4	1 11/16x12	62	32	41	50
1JC46-20-20		31	1 1/4	-20	31.8	1 11/16x12	71	33	41	50
	1JC48-20-20	31	1 1/4	-20	31.8	1 11/16x12	85	36	50	50

Approved **fitting series** for **hose types**, depending on size: Also available in stainless steel. Details can be found in CAT 4400.1/UK

46 or 48	441	461LT	462	462TC	462ST	629PU	692PU Twin										
46	463	492	492ST	492TC	692	692Twin	692TC	BCH1									
48	301SN	304	387	387ST	387TC	421RH	421SN	426	421TC	436	441RH	462PU	462PU Twin	BCH2	HT2	...	
	471TC	477	477ST	477TC	477RH	487	487ST	487TC	493	787	787TC	787ST	797	797TC	797ST	811	881

JS ORFS Swivel Female (Long)

ISO 12151-1-SWSB
SAE J516 – ORFS

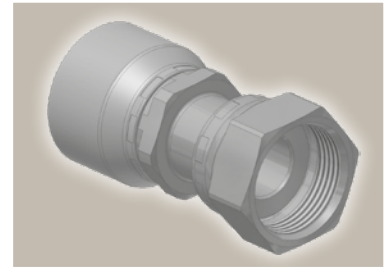
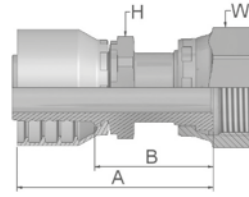

Part Number		Hose I.D.				Thread	A	B	H	W
46 series	48 series	DN	Inch	Size	mm	UNF	mm	mm	mm	mm
1JS46-4-4		6	1/4	-4	6.4	9/16x18	53	29	14	17
	1JS48-4-4	6	1/4	-4	6.4	9/16x18	51	29	14	17
1JS46-6-4		6	1/4	-4	6.4	11/16x16	56	31	17	22
	1JS48-6-4	6	1/4	-4	6.4	11/16x16	54	31	17	22
1JS46-6-5	1JS48-6-5	8	5/16	-5	7.9	11/16x16	55	31	17	22
	1JS48-4-6	10	3/8	-6	9.5	9/16x18	53	31	14	17
1JS46-6-6	1JS48-6-6	10	3/8	-6	9.5	11/16x16	52	29	17	22
1JS46-8-6	1JS48-8-6	10	3/8	-6	9.5	13/16x16	58	35	19	24
1JS46-6-8	1JS48-6-8	12	1/2	-8	12.7	11/16x16	52	29	17	22
1JS46-8-8	1JS48-8-8	12	1/2	-8	12.7	13/16x16	57	33	22	24
1JS46-10-8	1JS48-10-8	12	1/2	-8	12.7	1x14	63	39	24	30
1JS46-10-10	1JS48-10-10	16	5/8	-10	15.9	1x14	65	39	24	30
1JS46-12-10	1JS48-12-10	16	5/8	-10	15.9	1 3/16x12	70	45	30	36
	1JS48-10-12	19	3/4	-12	19.1	1x14	65	39	24	30
1JS46-12-12	1JS48-12-12	19	3/4	-12	19.1	1 3/16x12	71	45	30	36
1JS46-16-12	1JS48-16-12	19	3/4	-12	19.1	1 7/16x12	73	47	36	41
1JS46-16-16	1JS48-16-16	25	1	-16	25.4	1 7/16x12	76	46	36	41
1JS46-20-20		31	1 1/4	-20	31.8	1 11/16x12	88	50	41	50
	1JS48-20-20	31	1 1/4	-20	31.8	1 11/16x12	102	54	46	50
	1JS48-24-24	38	1 1/2	-24	38.1	2x12	99	62	50	60

46/48 Series

Approved **fitting series** for hose types, depending on size: Also available in stainless steel. Details can be found in CAT 4400.1/UK

46 or 48	441	461LT	462	462TC	462ST	629PU	692PU Twin										
46	463	492	492ST	492TC	692	692Twin	692TC	BCH1									
48	301SN	304	387	387ST	387TC	421RH	421SN	426	421TC	436	441RH	462PU	462PU Twin	BCH2	HT2	...	
	471TC	477	477ST	477TC	477RH	487	487ST	487TC	493	787	787TC	787ST	797	797TC	797ST	811	881

J7 Female ORFS – Swivel 45° Elbow

ISO 12151-1 – SWE 45°
SAE J516 – ORFS 45°

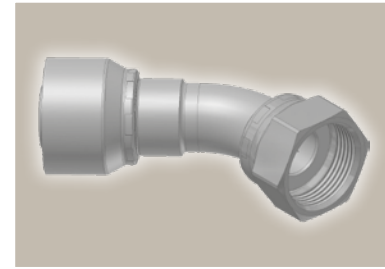
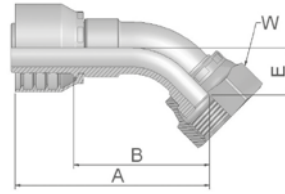

Part Number		Hose I.D.				Thread	A	B	E	W
46 series	48 series	DN	Inch	Size	mm	UNF	mm	mm	mm	mm
1J746-4-4	1J748-4-4	6	1/4	-4	6.4	9/16x18	54	31	10	17
1J746-6-4	1J748-6-4	6	1/4	-4	6.4	11/16x16	53	30	11	22
1J746-8-4	1J748-8-4	6	1/4	-4	6.4	13/16x16	59	34	15	24
1J746-6-5	1J748-6-5	8	5/16	-5	7.9	11/16x16	56	32	11	22
1J746-6-6	1J748-6-6	10	3/8	-6	9.5	11/16x16	54	31	11	22
1J746-8-6	1J748-8-6	10	3/8	-6	9.5	13/16x16	59	36	15	24
1J746-6-8		12	1/2	-8	12.7	11/16x16	57	33	11	22
	1J748-6-8	12	1/2	-8	12.7	11/16	57	33	11	22
1J746-8-8	1J748-8-8	12	1/2	-8	12.7	13/16x16	61	38	15	24
1J746-10-8	1J748-10-8	12	1/2	-8	12.7	1x14	65	41	16	30
1J746-12-8	1J748-12-8	12	1/2	-8	12.7	1 3/16x12	77	53	21	36
1J746-10-10	1J748-10-10	16	5/8	-10	15.9	1x14	67	42	16	30
1J746-12-10	1J748-12-10	16	5/8	-10	15.9	1 3/16x12	80	55	21	36
1J746-10-12	1J748-10-12	19	3/4	-12	19.1	1x14	73	47	16	30
1J746-12-12	1J748-12-12	19	3/4	-12	19.1	1 3/16x12	83	57	21	36
1J746-16-12	1J748-16-12	19	3/4	-12	19.1	1 7/16x12	94	68	24	41
1J746-12-16	1J748-12-16	25	1	-16	25.4	1 3/16x12	91	61	21	36
1J746-16-16	1J748-16-16	25	1	-16	25.4	1 7/16x12	99	69	24	41
1J746-20-16	1J748-20-16	25	1	-16	25.4	1 11/16x12	101	71	25	50
1J746-20-20		31	1 1/4	-20	31.8	1 11/16x12	124	86	26	50
	1J748-20-20	31	1 1/4	-20	31.8	1 11/16x12	130	82	27	50
	1J748-24-24	38	1 1/2	-24	38.1	2x12	148	110	40	60

Approved **fitting series** for **hose types**, depending on size: Also available in stainless steel. Details can be found in CAT 4400.1/UK

46	or	48	441	461LT	462	462TC	462ST	629PU	692PU Twin							
46	463	492	492ST	492TC	692	692Twin	692TC	BCH1								
48	301SN	304	387	387ST	387TC	421RH	421SN	426	421TC	436	441RH	462PU	462PU Twin	BCH2	HT2	...
471TC	477	477ST	477TC	477RH	487	487ST	487TC	493	787	787TC	787ST	797	797TC	797ST	811	881

J9

Female ORFS – Swivel 90° Elbow – Short Drop

ISO 12151-1 – SWES
SAE J516 – ORFS 90°

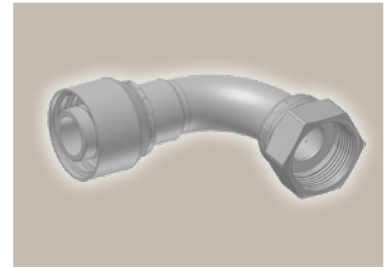
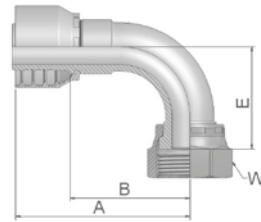

Part Number		Hose I.D.				Thread	A	B	E	W
46 series	48 series	DN	Inch	Size	mm	UNF	mm	mm	mm	mm
1J946-4-4	1J948-4-4	6	1/4	-4	6.4	9/16x18	52	29	21	17
1J946-6-4	1J948-6-4	6	1/4	-4	6.4	11/16x16	51	27	23	22
	1J948-8-4	6	1/4	-4	6.4	13/16x16	50	26	29	24
1J946-6-5	1J948-6-5	8	5/16	-5	7.9	11/16x16	53	29	23	22
1J946-4-6	1J948-4-6	10	3/8	-6	9.5	9/16x18	47	24	21	17
1J946-6-6	1J948-6-6	10	3/8	-6	9.5	11/16x16	52	29	23	22
1J946-8-6	1J948-8-6	10	3/8	-6	9.5	13/16x16	53	30	29	24
1J946-6-8	1J948-6-8	12	1/2	-8	12.7	11/16x16	53	29	23	22
1J946-8-8	1J948-8-8	12	1/2	-8	12.7	13/16x16	55	32	29	24
1J946-10-8	1J948-10-8	12	1/2	-8	12.7	1x14	66	42	32	30
1J946-12-8	1J948-12-8	12	1/2	-8	12.7	1 3/16x12	58	34	48	36
1J946-10-10	1J948-10-10	16	5/8	-10	15.9	1x14	65	39	32	30
1J946-12-10	1J948-12-10	16	5/8	-10	15.9	1 3/16x12	71	45	48	36
1J946-10-12	1J948-10-12	19	3/4	-12	19.1	1x14	69	43	32	30
1J946-12-12	1J948-12-12	19	3/4	-12	19.1	1 3/16x12	80	54	48	36
1J946-16-12		19	3/4	-12	19.1	1 7/16x12	88	62	56	41
1J946-12-16		25	1	-16	25.4	1 3/16x12	88	58	48	36
	1J948-12-16	25	1	-16	25.4	1 3/16 12	88	58	48	36
1J946-16-16	1J948-16-16	25	1	-16	25.4	1 7/16x12	98	68	56	41
1J946-20-16	1J948-20-16	25	1	-16	25.4	1 11/16x12	104	74	64	50
1J946-20-20		31	1 1/4	-20	31.8	1 11/16x12	124	86	64	50
	1J948-20-20	31	1 1/4	-20	31.8	1 11/16x12	129	82	64	50
	1J948-24-24	38	1 1/2	-24	38.1	2x12	140	102	82	60

46/48 Series

Approved **fitting series** for hose types, depending on size: Also available in stainless steel. Details can be found in CAT 4400.1/UK

46 or 48	441	461LT	462	462TC	462ST	629PU	692PU Twin										
46	463	492	492ST	492TC	692	692Twin	692TC	BCH1									
48	301SN	304	387	387ST	387TC	421RH	421SN	426	421TC	436	441RH	462PU	462PU Twin	BCH2	HT2	...	
	471TC	477	477ST	477TC	477RH	487	487ST	487TC	493	787	787TC	787ST	797	797TC	797ST	811	881

J1 Female ORFS – Swivel 90° Elbow – Long Drop

ISO 12151-1 – SWEL
SAE J 516 – ORFS 90° L

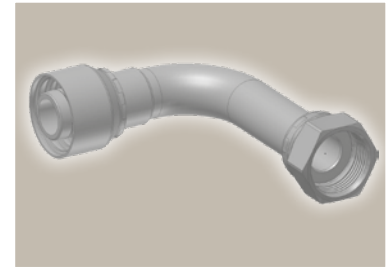
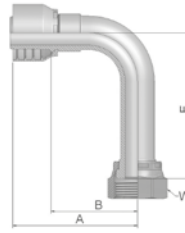

Part Number		Hose I.D.				Thread	A	B	E	W
46 series	48 series	DN	Inch	Size	mm	UNF	mm	mm	mm	mm
1J146-4-4	1J148-4-4	6	1/4	-4	6.4	9/16x18	58	35	46	17
	1J148-6-4	6	1/4	-4	6.4	11/16x16	59	36	54	22
1J146-6-6	1J148-6-6	10	3/8	-6	9.5	11/16x16	58	35	54	22
1J146-8-6	1J148-8-6	10	3/8	-6	9.5	13/16x16	59	37	64	24
1J146-8-8	1J148-8-8	12	1/2	-8	12.7	13/16x16	61	37	64	24
	1J148-10-8	12	1/2	-8	12.7	1x14	66	42	70	30
1J146-10-10	1J148-10-10	16	5/8	-10	15.9	1x14	65	39	70	30
1J146-12-12	1J148-12-12	19	3/4	-12	19.1	1 3/16x12	80	54	96	36
	1J148-16-16	25	1	-16	25.4	1 7/16x12	98	68	114	41

J5 Female ORFS – Swivel 90° Elbow – Medium Drop

ISO 12151-1 – SWEM – ORFS 90° M

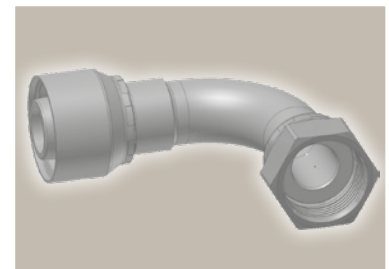
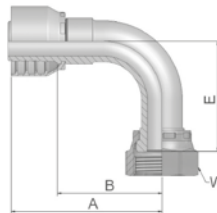

Part Number		Hose I.D.				Thread	A	B	E	W
46 series	48 series	DN	Inch	Size	mm	UNF	mm	mm	mm	mm
1J546-4-4	1J548-4-4	6	1/4	-4	6.4	9/16x18	59	35	32	17
1J546-6-4	1J548-6-4	6	1/4	-4	6.4	11/16x16	62	39	38	22
1J546-6-6	1J548-6-6	10	3/8	-6	9.5	11/16x16	58	35	38	22
1J546-8-6	1J548-8-6	10	3/8	-6	9.5	13/16x16	60	37	41	24
1J546-8-8	1J548-8-8	12	1/2	-8	12.7	13/16x16	60	37	41	24
1J546-10-10	1J548-10-10	16	5/8	-10	15.9	1x14	65	39	47	30
1J546-12-12	1J548-12-12	19	3/4	-12	19.1	1 3/16x12	80	54	58	36

Approved **fitting series** for **hose types**, depending on size: Also available in stainless steel. Details can be found in CAT 4400.1/UK

46 or 48	441	461LT	462	462TC	462ST	629PU	692PU Twin										
46	463	492	492ST	492TC	692	692Twin	692TC	BCH1									
48	301SN	304	387	387ST	387TC	421RH	421SN	426	421TC	436	441RH	462PU	462PU Twin	BCH2	HT2	...	
	471TC	477	477ST	477TC	477RH	487	487ST	487TC	493	787	787TC	787ST	797	797TC	797ST	811	881

JM

ORFS Male

ISO 12151-1-S – SAE J516

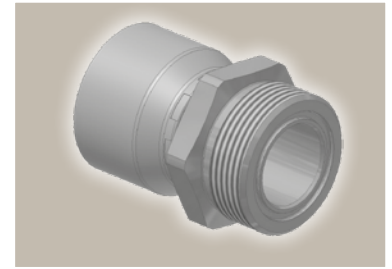
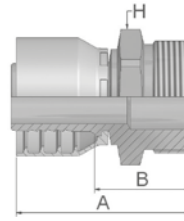

Part Number		Hose I.D.				Thread	A	B	H
46 series	48 series	DN	Inch	Size	mm	UNF	mm	mm	mm
1JM46-4-4		6	1/4	-4	6.4	9/16x18	46	22	17
	1JM48-4-4	6	1/4	-4	6.4	9/16x18	44	22	17
1JM46-6-4		6	1/4	-4	6.4	11/16x16	48	24	19
	1JM48-6-4	6	1/4	-4	6.4	11/16x16	46	24	19
1JM46-6-5	1JM48-6-5	8	5/16	-5	7.9	11/16x16	53	26	19
1JM46-6-6	1JM48-6-6	10	3/8	-6	9.5	11/16x16	47	24	19
1JM46-8-6	1JM48-8-6	10	3/8	-6	9.5	13/16x16	50	27	22
1JM46-8-8	1JM48-8-8	12	1/2	-8	12.7	13/16x16	51	27	22
1JM46-10-8	1JM48-10-8	12	1/2	-8	12.7	1x14	55	32	27
1JM46-10-10	1JM48-10-10	16	5/8	-10	15.9	1x14	57	32	27
1JM46-12-10	1JM48-12-10	16	5/8	-10	15.9	1 3/16x12	59	34	32
1JM46-12-12	1JM48-12-12	19	3/4	-12	19.1	1 3/16x12	60	34	32
1JM46-16-12	1JM48-16-12	19	3/4	-12	19.1	1 7/16x12	64	38	41
1JM46-16-16	1JM48-16-16	25	1	-16	25.4	1 7/16x12	67	37	41
1JM46-20-16	1JM48-20-16	25	1	-16	25.4	1 11/16x12	66	36	46
	1JM48-20-20	31	1 1/4	-20	31.8	1 11/16x12	85	37	46

To select corresponding O-ring see section Eb.

JD

Male ORFS Bulkhead with Locknut Straight (with O-ring)

ISO 12151-1 – SAE J516

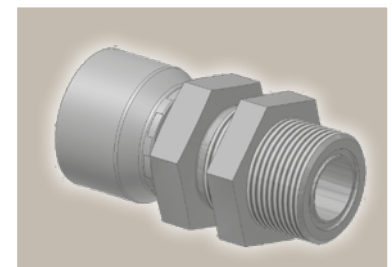
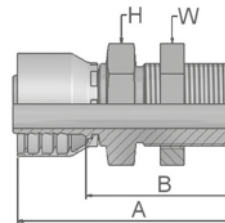

Part Number		Hose I.D.				Thread	A	B	H	W
46 series	48 series	DN	Inch	Size	mm	UNF	mm	mm	mm	mm
1JD46-4-4	1JD48-4-4	6	1/4	-4	6.4	9/16x18	72	48	22	22
1JD46-6-6	1JD48-6-6	10	3/8	-6	9.5	11/16x16	73	51	27	27
1JD46-8-8	1JD48-8-8	12	1/2	-8	12.7	13/16x16	79	56	30	30
1JD46-10-10	1JD48-10-10	16	5/8	-10	15.9	1x14	86	60	32	36
1JD46-12-12	1JD48-12-12	19	3/4	-12	19.1	1 3/16x12	88	63	36	38
	1JD48-16-16	25	1	-16	25.4	1 7/16x12	94	64	46	46

To select corresponding O-ring see section Eb.

Approved **fitting series** for **hose types**, depending on size: Also available in stainless steel. Details can be found in CAT 4400.1/UK

46 or 48	441	461LT	462	462TC	462ST	629PU	692PU Twin										
46	463	492	492ST	492TC	692	692Twin	692TC	BCH1									
48	301SN	304	387	387ST	387TC	421RH	421SN	426	421TC	436	441RH	462PU	462PU Twin	BCH2	HT2	...	
	471TC	477	477ST	477TC	477RH	487	487ST	487TC	493	787	787TC	787ST	797	797TC	797ST	811	881

FU Female BSP Parallel Pipe Swivel – Straight (30° Flare)

ISO 228-1 – JIS B8363 – GUI

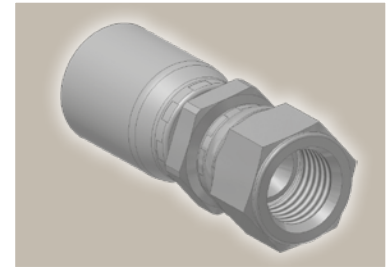
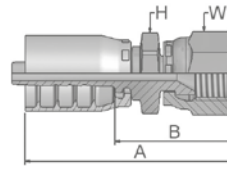

Part Number		Hose I.D.				Thread	A	B	H	W
46 series	48 series	DN	Inch	Size	mm	BSP	mm	mm	mm	mm
1FU46-4-4	1FU48-4-4	6	1/4	-4	6.4	1/4x19	50	32	19	19
1FU46-6-6	1FU48-6-6	10	3/8	-6	9.5	3/8x19	58	35	24	22
1FU46-12-12	1FU48-12-12	19	3/4	-12	19.1	3/4x14	71	45	36	36
1FU46-16-16	1FU48-16-16	25	1	-16	25.4	1x11	76	46	41	41

GU Female BSP Parallel Pipe Swivel – Straight (60° Cone)

ISO 228-1 – JIS B8363 – GUO

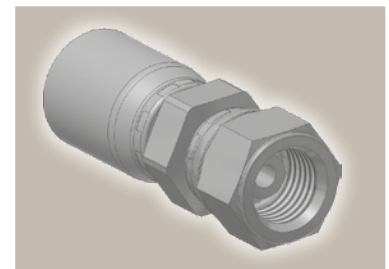
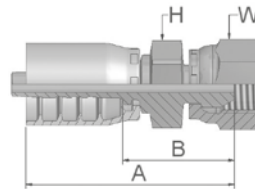

Part Number		Hose I.D.				Thread	A	B	H	W
46 series	48 series	DN	Inch	Size	mm	BSP	mm	mm	mm	mm
1GU46-4-4	1GU48-4-4	6	1/4	-4	6.4	1/4x19	55	33	19	19
1GU46-6-6	1GU48-6-6	10	3/8	-6	9.5	3/8x19	58	35	22	22
1GU46-8-8	1GU48-8-8	12	1/2	-8	12.7	1/2x14	55	32	27	27

Approved **fitting series** for **hose types**, depending on size: Also available in stainless steel. Details can be found in CAT 4400.1/UK

46 or 48	441 461LT 462 462TC 462ST 629PU 692PU Twin
46	463 492 492ST 492TC 692 692Twin 692TC BCH1
48	301SN 304 387 387ST 387TC 421RH 421SN 426 421TC 436 441RH 462PU 462PU Twin BCH2 HT2 ...
	471TC 477 477ST 477TC 477RH 487 487ST 487TC 493 787 787TC 787ST 797 797TC 797ST 811 881

MZ Female Metric – Swivel 90° Elbow (30° Flare)

JIS B8363

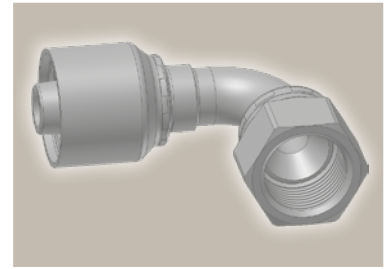
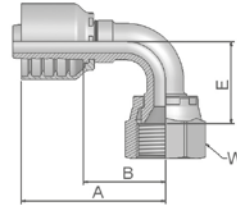

Part Number		Hose I.D.				Thread	A	B	E	W
46 series	48 series	DN	Inch	Size	mm	metric	mm	mm	mm	mm
1MZ46-4-4	1MZ48-4-4	6	1/4	-4	6.4	M14x1.5	48	24	23	19
1MZ46-6-6	1MZ48-6-6	10	3/8	-6	9.5	M18x1.5	51	28	29	24
1MZ46-8-8	1MZ48-8-8	12	1/2	-8	12.7	M22x1.5	55	31	31	27

Approved **fitting series** for hose types, depending on size: Also available in stainless steel. Details can be found in CAT 4400.1/UK

46 or 48	441	461LT	462	462TC	462ST	629PU	692PU Twin										
46	463	492	492ST	492TC	692	692Twin	692TC	BCH1									
48	301SN	304	387	387ST	387TC	421RH	421SN	426	421TC	436	441RH	462PU	462PU Twin	BCH2	HT2	...	
	471TC	477	477ST	477TC	477RH	487	487ST	487TC	493	787	787TC	787ST	797	797TC	797ST	811	881

CW Power Cleaner Connection

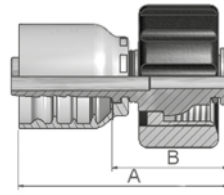

Part Number		Hose I.D.				Thread	Tube O.D.	A	B
46 series	48 series	DN	Inch	Size	mm	metric	mm	mm	mm
1CW46-15-4	1CW48-15-4	6	1/4	-4	6.4	M22x1.5	15	53	29
1CW46-15-5	1CW48-15-5	8	5/16	-5	7.9	M22x1.5	15	53	29
1CW46-15-6	1CW48-15-6	10	3/8	-6	9.5	M22x1.5	15	52	29
1CW46-15-8	1CW48-15-8	12	1/2	-8	12.7	M22x1.5	15	53	29

Rubber hand grip Part-No. WKS-X-XXX in black or blue please find on page Eb-17.

NW Female Kärcher Metric Cleaning Hose Fitting Swivel – Straight

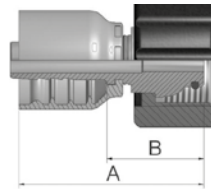

Part Number		Hose I.D.				Thread	A	B
46 series	48 series	DN	Inch	Size	mm	metric	mm	mm
1NW46-15-4	1NW48-15-4	6	1/4	-4	6.4	M22x1.5	52	29
1NW46-15-5	1NW48-15-5	8	5/16	-5	7.9	M22x1.5	52	29
1NW46-15-6	1NW48-15-6	10	3/8	-6	9.5	M22x1.5	48	25

Rubber hand grip Part-No. WKS-X-XXX in black or blue please find on page Eb-17.

Approved **fitting series** for **hose types**, depending on size: Also available in stainless steel. Details can be found in CAT 4400.1/UK

46 or 48	441 461LT 462 462TC 462ST 629PU 692PU Twin
46	463 492 492ST 492TC 692 692Twin 692TC BCH1
48	301SN 304 387 387ST 387TC 421RH 421SN 426 421TC 436 441RH 462PU 462PU Twin BCH2 HT2 ...
	471TC 477 477ST 477TC 477RH 487 487ST 487TC 493 787 787TC 787ST 797 797TC 797ST 811 881

PW **Male Kärcher
Metric Cleaning Hose Fitting
Rigid – Straight**

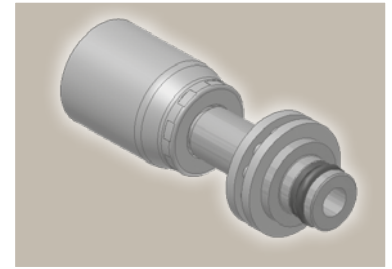
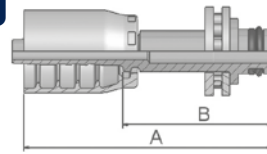

Part Number		Hose I.D.				Tube	A	B
46 series	48 series	DN	Inch	Size	mm	O.D. mm	mm	mm
1PW46-10-4	1PW48-10-4	6	1/4	-4	6.4	10	60	36
1PW46-11-4	1PW48-11-4	6	1/4	-4	6.4	11	60	37
1PW46-10-5	1PW48-10-5	8	5/16	-5	7.9	10	60	36
1PW46-11-5	1PW48-11-5	8	5/16	-5	7.9	11	61	37
1PW46-10-6	1PW48-10-6	10	3/8	-6	9.5	10	60	37

Rubber hand grip Part-No. WKS-X-XXX in black or blue please find on page Eb-17.

1PWxx-11-x = with ball bearing as shown above

1PWxx-10-x = without ball bearing

Approved **fitting series** for hose types, depending on size: Also available in stainless steel. Details can be found in CAT 4400.1/UK

46 or 48	441	461LT	462	462TC	462ST	629PU	692PU Twin										
46	463	492	492ST	492TC	692	692Twin	692TC	BCH1									
48	301SN	304	387	387ST	387TC	421RH	421SN	426	421TC	436	441RH	462PU	462PU Twin	BCH2	HT2	...	
	471TC	477	477ST	477TC	477RH	487	487ST	487TC	493	787	787TC	787ST	797	797TC	797ST	811	881

XU Female Metric – Swivel Straight (30° Flare)

JIS B8363

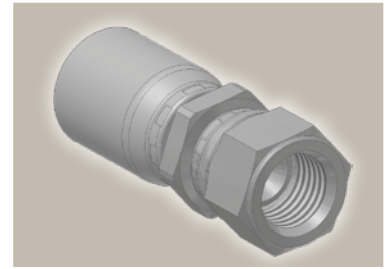
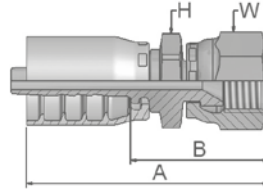



Part Number		Hose I.D.				Thread	A	B	H	W
46 series	48 series	DN	Inch	Size	mm	metric	mm	mm	mm	mm
	1XU48-10-10	16	5/8	-10	15.9	M24x1.5	69	44	30	32
	1XU48-12-12	19	3/4	-12	19.1	M30x1.5	73	47	32	36

Approved **fitting series** for **hose types**, depending on size: Also available in stainless steel. Details can be found in CAT 4400.1/UK

46 or 48	441	461LT	462	462TC	462ST	629PU	692PU Twin										
46	463	492	492ST	492TC	692	692Twin	692TC	BCH1									
48	301SN	304	387	387ST	387TC	421RH	421SN	426	421TC	436	441RH	462PU	462PU Twin	BCH2	HT2	...	
	471TC	477	477ST	477TC	477RH	487	487ST	487TC	493	787	787TC	787ST	797	797TC	797ST	811	881

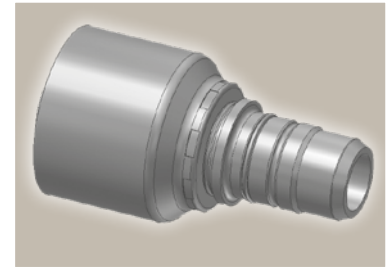
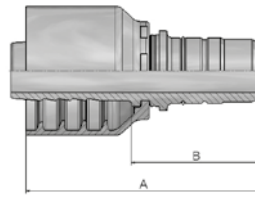
EN UPTC – Male
Straight



Part Number		 Hose I.D.				Tube	A	B
46 series	48 series	DN	Inch	Size	mm	O.D. mm	mm	mm
1EN46-8-4	1EN48-8-4	6	1/4	-4	6.4	8	49	26
1EN46-10-5	1EN48-10-5	8	5/16	-5	7.9	10	50	26
1EN46-12-6	1EN48-12-6	10	3/8	-6	9.5	12	50	27
1EN46-15-8	1EN48-15-8	12	1/2	-8	12.7	15	53	29
1EN46-18-10	1EN48-18-10	16	5/8	-10	15.9	18	56	31
1EN46-22-12	1EN48-22-12	19	3/4	-12	19.1	22	57	32

EU UPTC – Male
45° Elbow

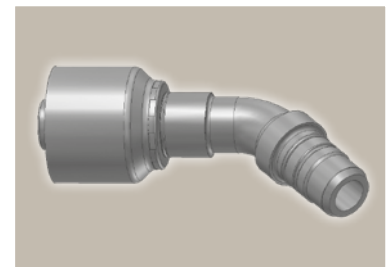
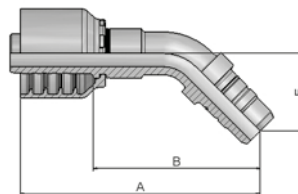

Part Number		 Hose I.D.				Tube	A	B	E
46 series	48 series	DN	Inch	Size	mm	O.D. mm	mm	mm	mm
1EU46-8-4	1EU48-8-4	6	1/4	-4	6.4	8	66	43	23
1EU46-10-5	1EU48-10-5	8	5/16	-5	7.9	10	68	45	23
1EU46-12-6	1EU48-12-6	10	3/8	-6	9.5	12	71	48	23
1EU46-15-8	1EU48-15-8	12	1/2	-8	12.7	15	78	54	25
1EU46-18-10	1EU48-18-10	16	5/8	-10	15.9	18	84	59	32
1EU46-22-12	1EU48-22-12	19	3/4	-12	19.1	22	95	69	33

Approved **fitting series** for hose types, depending on size: Also available in stainless steel. Details can be found in CAT 4400.1/UK

46 or 48	441 461LT 462 462TC 462ST 629PU 692PU Twin
46	463 492 492ST 492TC 692 692Twin 692TC BCH1
48	301SN 304 387 387ST 387TC 421RH 421SN 426 421TC 436 441RH 462PU 462PU Twin BCH2 HT2 ...
	471TC 477 477ST 477TC 477RH 487 487ST 487TC 493 787 787TC 787ST 797 797TC 797ST 811 881

ET **UPTC – Male**
90° Elbow

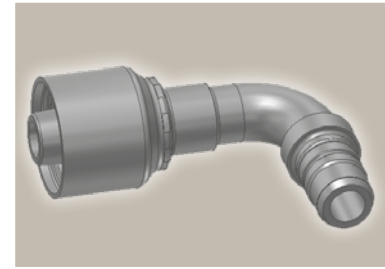
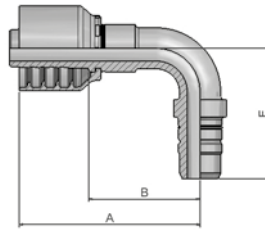

Part Number		Hose I.D.				Tube	A	B	E
46 series	48 series	DN	Inch	Size	mm	O.D. mm	mm	mm	mm
1ET46-8-4	1ET48-8-4	6	1/4	-4	6.4	8	59	36	39
1ET46-10-5	1ET48-10-5	8	5/16	-5	7.9	10	58	35	39
1ET46-12-6	1ET48-12-6	10	3/8	-6	9.5	12	57	34	40
1ET46-15-8	1ET48-15-8	12	1/2	-8	12.7	15	61	38	45
1ET46-18-10	1ET48-18-10	16	5/8	-10	15.9	18	65	39	57
1ET46-22-12	1ET48-22-12	19	3/4	-12	19.1	22	80	54	64

Approved **fitting series** for **hose types**, depending on size: Also available in stainless steel. Details can be found in CAT 4400.1/UK

46 or 48	441	461LT	462	462TC	462ST	629PU	692PU Twin										
46	463	492	492ST	492TC	692	692Twin	692TC	BCH1									
48	301SN	304	387	387ST	387TC	421RH	421SN	426	421TC	436	441RH	462PU	462PU Twin	BCH2	HT2	...	
	471TC	477	477ST	477TC	477RH	487	487ST	487TC	493	787	787TC	787ST	797	797TC	797ST	811	881

Shell

Page Cd-1

10048

Cd-1

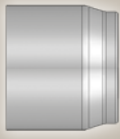

No-Skive shell

SAE

Page Cd-1

01

Cd-1

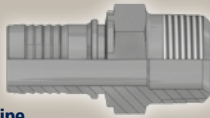

Male NPTF Pipe
Rigid – Straight
SAE J476A / J516 – AGN

Flange

Page Cd-2

15

Cd-2

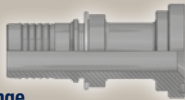

ISO 6162-1-Flange
Straight
ISO 12151-3-S-L – SFL
(21.0 MPa/ 3000 psi)

17

Cd-2

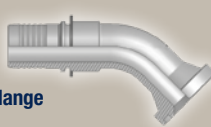

ISO 6162-1 Flange
45° Elbow
ISO 12151-3 – E45 – L – SFL 45°
(21.0 MPa/ 3000 psi)

19

Cd-2



ISO 6162-1-Flange
90° Elbow
ISO 12151-3 – E – L – SFL 90°
(21.0 MPa/ 3000 psi)

Crimp Diameters please find on www.parker.com/crimpsource-euro

10048 No-Skive shell

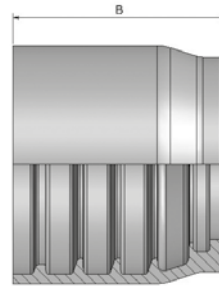





Only for use with adjustable crimpers.

Part Number	 Hose I.D.				B mm
	DN	Inch	Size	mm	
10048-40	63	2 1/2	-40	63.5	67
10048-48	76	3	-48	76.2	75

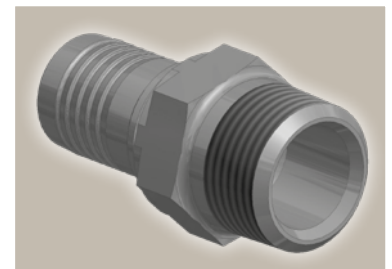
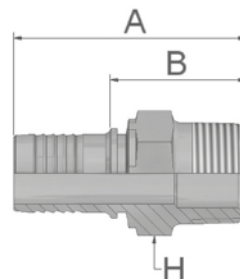
01 Male NPTF Pipe Rigid – Straight

SAE J476A / J516 – AGN



Part Number	 Hose I.D.				 Thread NPTF	A mm	B mm	 H mm
	DN	Inch	Size	mm				
K0147-48-40	63	2 1/2	-40	63.5	3-8	135	73	95
K0147-48-48	76	3	-48	76.2	3-8	143	73	95

2piece – Series 48

Approved fitting series for hose types, depending on size:

48 187 187TC 187ST 462TC

15 ISO 6162-1-Flange Straight

ISO 12151-3-S-L – SFL
(21.0 MPa/ 3000 psi)

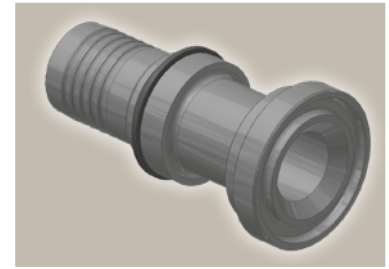
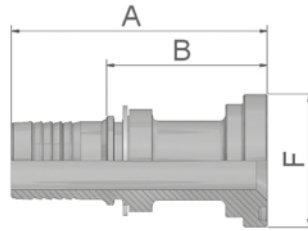

Part Number	Hose I.D.				Flange Inch	A mm	B mm	F mm
	DN	Inch	Size	mm				
K1547-40-40	63	2 1/2	-40	63.5	2 1/2	127	65	84
K1547-48-40	63	2 1/2	-40	63.5	3	137	75	102
K1547-48-48	76	3	-48	76.2	3	155	85.5	102

To select corresponding half-flange and O-ring see section Eb.

17 ISO 6162-1 Flange 45° Elbow

ISO 12151-3 – E45 – L – SFL 45°
(21.0 MPa/ 3000 psi)

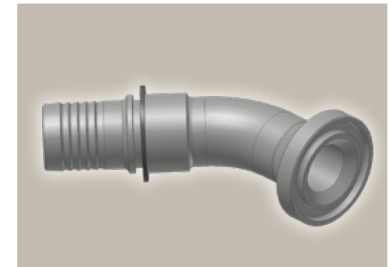
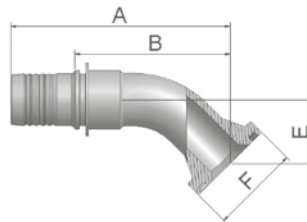

Part Number	Hose I.D.				Flange Inch	A mm	B mm	E mm	F mm
	DN	Inch	Size	mm					
K1747-40-40	63	2 1/2	-40	63.5	2 1/2	179	118	47	84
K1747-48-48	76	3	-48	76.2	3	204	134	53	102

To select corresponding half-flange and O-ring see section Eb.

19 ISO 6162-1-Flange 90° Elbow

ISO 12151-3 – E – L – SFL 90°
(21.0 MPa/ 3000 psi)

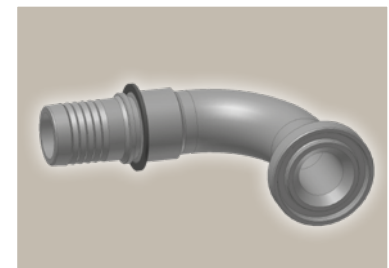
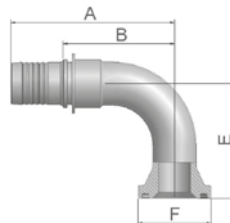

Part Number	Hose I.D.				Flange Inch	A mm	B mm	E mm	F mm
	DN	Inch	Size	mm					
K1947-40-40	63	2 1/2	-40	63.5	2 1/2	177	116	111	84
K1947-48-48	76	3	-48	76.2	3	206	136	131	102

To select corresponding half-flange and O-ring see section Eb.

Approved **fitting series** for hose types, depending on size:

48 187 187TC 187ST 462TC

Shell

Page Ce-1

100IF

Ce-1



No-Skive shell

Flange

Page Ce-2 – Ce-3

15

Ce-2



**ISO 6162-1-Flange
Straight**

ISO 12151-3-S-L – SFL
(21.0 MPa/ 3000 psi)

17

Ce-2

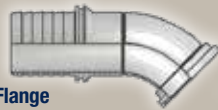

**ISO 6162-1 Flange
45° Elbow**

ISO 12151-3 – E45 – L – SFL 45°
(21.0 MPa/ 3000 psi)

19

Ce-3

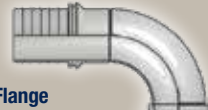

**ISO 6162-1-Flange
90° Elbow**

ISO 12151-3 – E – L – SFL 90°
(21.0 MPa/ 3000 psi)

Crimp Diameters please find on www.parker.com/crimpsource-euro

100IF No-Skive shell



Only for use with adjustable crimpers.

Part Number	 Hose I.D.				B mm
	DN	Inch	Size	mm	
100IF-40	63	2 1/2	-40	63.5	63
100IF-48	76	3	-48	76.2	68
100IF-56	90	3 1/2	-56	88.9	100
100IF-64	100	4	-64	101.6	95
100IF-80	127	5	-80	127.0	110
100IF-96	152	6	-96	152.4	142

2piece – Series IF

Approved **fitting series** for hose types, depending on size:

811 811S

15 ISO 6162-1-Flange Straight

ISO 12151-3-S-L – SFL
(21.0 MPa/ 3000 psi)

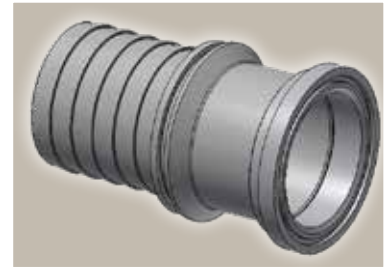
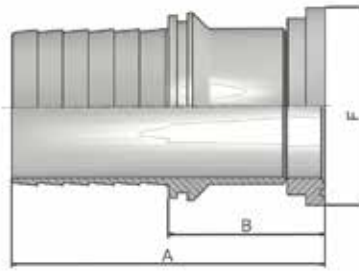

Part Number	Hose I.D.				Flange Inch	A mm	B mm	F mm
	DN	Inch	Size	mm				
K15IF-40-40	63	2 1/2	-40	63.5	2 1/2	120	67	84
K15IF-48-48	76	3	-48	76.2	3	166	95	102
K15IF-56-56	90	3 1/2	-56	88.9	3 1/2	183	91	114
K15IF-64-64	100	4	-64	101.6	4	206	103	127
K15IF-80-80	127	5	-80	127.0	5	221	118	152
K15IF-80-96	152	6	-96	152.4	5	281	151	152

To select corresponding half-flange and O-ring see section Eb.

17 ISO 6162-1 Flange 45° Elbow

ISO 12151-3 – E45 – L – SFL 45°
(21.0 MPa/ 3000 psi)

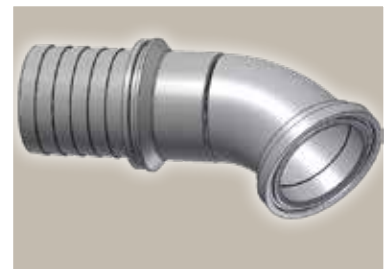
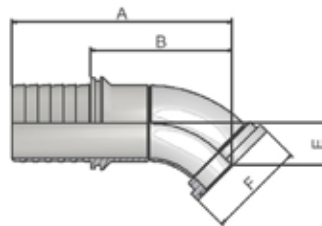

Part Number	Hose I.D.				Flange Inch	A mm	B mm	E mm	F mm
	DN	Inch	Size	mm					
K17IF-40-40	63	2 1/2	-40	63.5	2 1/2	164	111	47	84
K17IF-48-48	76	3	-48	76.2	3	224	153	53	102
K17IF-56-56	90	3 1/2	-56	88.9	3 1/2	258	166	50	114
K17IF-64-64	100	4	-64	101.6	4	294	191	57	127
K17IF-80-80	127	5	-80	127.0	5	341	238	92	152
K17IF-80-96	152	6	-96	152.4	5	401	271	92	152

SAE flange halves see in section Eb.

Fittings with standard O-ring seals can be used for temperatures from -40 °C up to +105 °C.
O-rings see section Eb. Special O-rings are available on request.

Approved **fitting series** for hose types, depending on size:

IF 811 811S

19 ISO 6162-1-Flange 90° Elbow

ISO 12151-3 – E- L – SFL 90°
(21.0 MPa/ 3000 psi)

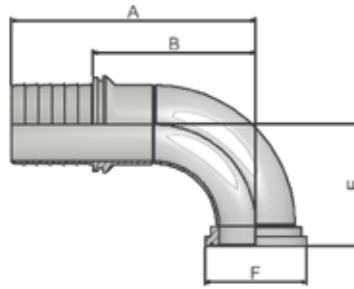

Part Number	Hose I.D.				Flange Inch	A mm	B mm	E mm	F mm
	DN	Inch	Size	mm					
K19IF-40-40	63	2 1/2	-40	63.5	2 1/2	162	109	111	84
K19IF-48-48	76	3	-48	76.2	3	226	155	131	102
K19IF-56-56	90	3 1/2	-56	88.9	3 1/2	275	183	137	114
K19IF-64-64	100	4	-64	101.6	4	314	211	159	127
K19IF-80-80	127	5	-80	127.0	5	361	258	241	152
K19IF-80-96	152	6	-96	152.4	5	421	291	241	152

SAE flange halves see in section Eb.

Fittings with standard O-ring seals can be used for temperatures from -40 °C up to +105 °C.

O-rings see section Eb. Special O-rings are available on request.

Approved **fitting series** for hose types, depending on size:





Hydraulic Hoses and Fittings

High Pressure



ENGINEERING YOUR SUCCESS.

High Pressure Hoses and Fittings

Three systems for heavy duty performers

Multispiral Parkrimp *No-Skive*

Crimpable with
Parkrimp System



Compact Spiral Interlock *No-Skive*

Crimpable with
Parkrimp System



ParLock Interlock Skive

Crimpable with
adjustable crimpers



Applications

The definitive hose range for all
high pressure applications



Crimper systems you can trust

Parkrimp crimpers for *No-Skive* one-piece fittings



KarryKrimp® 2



KarryKrimp® 2
Bench Mount



Parkrimp®

Adjustable crimpers for two-piece ParLock fittings



TH8E-530



TH 8E-380-CM



TH 8E-480-CM



Parkrimp *No-Skive*
one-piece fittings



ParLock
two-piece skive fittings

Good – Better – Best – engineered for your success.

New classification for easier hose and fitting selection

Good

“Good” hoses are cost-effective products – fully meeting the main parameters of the traditional international standards and exceeding them in particular requirements, such as service life, appearance, environmental aspects etc. (BCH braided hoses in combination with fitting series 16, 46, 48 in the medium pressure range and SX spiral hoses with fitting series 73 and 77).

Better

The category “Better” includes hose products which are exceeding the traditional international standards in the main parameters, such as working pressure, temperature, flexibility, impulse pressure resistance etc. These are the main qualities appreciated by the customers at the Parker well known *No-Skive* hoses – *Elite* braided in the medium pressure range and Parkrimp spiral.

Best

Category “Best” contains GLOBALCORE hose products which are meeting or even exceeding the latest and most demanding International Standard ISO 18752. GLOBALCORE is the world’s first high performance, cohesive hose and fitting range GLOBALCORE hoses have constant working pressures of 21.0 or 28.0 MPa in the medium pressure and 35.0 or 42.0 MPa in the high pressure range.

Good High Pressure

SX35, SX42

Fitting Series



* MP (Multipack) only

Better High Pressure

**Parkrimp
701, 731**

Fitting Series



Best High Pressure

**GLOBALCORE™
787, 797**

Fitting Series



Good

Newly developed high performance *No-Skive* hoses

SX spiral hoses – meeting international technical standards – newly developed for demanding small and medium OEMs and general distribution.

SX35 Multispiral

ISO 3862 Type R13



Size -12, -16, -20
-40 °C up to +125 °C

Constant working pressure 35.0 MPa



Parker NO-SKIVE - SX35-12 WP 35,0 MPa (5000 PSI) I[®] ISO 3862 4SP / R13

SX42 Multispiral

ISO 3862 Type R15



Size -12, -16, -20
-40 °C up to +125 °C

Constant working pressure 42.0 MPa



Parker NO-SKIVE - SX42-12 WP 42,0 MPa (6000 PSI) I[®] ISO 3862 R15 - 19 m

Customers choice is the key

Good, Better, Best classification for easier hose and fitting selection

- Different levels for different markets and applications
- Help customers to make better buying decision
- Defined hose and fitting combination on hose layline
- Clear visibility of correct fitting
- Easy to understand
- Ensures quality of hose and fitting combination

Superior performance of Best hoses versus Better and Good hoses

- Bend radius up to 50% smaller
- Flexibility (bending force) up to 30% higher
- Weight up to 20% lower
- Dimensions up to 25% smaller area
- Impulse resistance and service life up to four times higher
- Working temperature up to 25% higher

Construction is one of the typical markets and applications where „Good hose and fittings“ are the preferred product selection.



GLOBALCORE™

The world's first high-performance, cohesive hose and fitting system

722 / 722TC / 722ST *No-Skive* GlobalCore

Resilient 4-wire spiral construction

Primary Applications



Parker's GlobalCore 722 spiral hose provides 28 MPa (4,000 psi) constant working pressure in sizes -6 through -16. Designed for high-pressure, high-impulse applications, 722 hose is offered in Standard, ToughCover and SuperTough cover options. It is one-half the bend radius of 100R12 hose, making it easy to install and reducing the amount of hose needed. Exceeding the ISO 18752 performance specification, Parker's 722 hose excels in multiple applications around the world.

787 / 787TC / 787ST *No-Skive* GlobalCore

Lighter weight, high flexibility make installation easy

Primary Applications



Parker's GlobalCore 787 hose provides 35 MPa (5,000 psi) constant working pressure in all sizes. Compared with conventional spiral hose, 787 hose offers measurably greater advantages in routing and installation, product size and weight, inventory savings and much more. The 787 hose exceeds the ISO 18752 performance specification.

797 / 797TC / 797ST *No-Skive* GlobalCore

Lighter weight, high flexibility make installation easy

Primary Applications

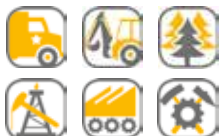

Parker's GlobalCore 797 hose provides 42 MPa (6,000 psi) constant working pressure in all sizes. Compared with conventional spiral hose, 797 hose offers measurably greater advantages in routing and installation, product size and weight, inventory savings and much more. The 797 hose exceeds the ISO 18752 performance specification.



GlobalCore significantly reduces system complexity



- ½ ISO 18752 minimum bend radius
- 28 MPa (4,000 psi) constant working pressure
- Exceeds ISO 18752 performance specification (BC and CC)
- 4-spiral construction for longer life in high-impulse, heavy-duty cycle applications
- TC cover provides 80 times the abrasion resistance compared to Standard rubber cover hoses
- ST cover provides 450 times the abrasion resistance compared to Standard rubber cover hoses



- ½ ISO 18752 minimum bend radius
- 35 MPa (5,000 psi) constant working pressure in all sizes
- Exceeds ISO 18752 performance specification (BC/DC)
- Nearly 30 % smaller O.D. by area than SAE spiral
- Twice the impulse/life – tested to 2,000,000 cycles
- Flex impulse tested, providing a hose superior in both performance and service life
- 30 % less hose weight than SAE spiral
- TC cover provides 80 times the abrasion resistance compared to Standard rubber cover hoses
- ST cover provides 450 times the abrasion resistance compared to Standard rubber cover hoses



- ½ the bend radius of SAE spiral
- 42 MPa (6,000 psi) constant working pressure in all sizes
- Exceeds ISO 18752 performance specification (BC/CC/DC)
- Nearly 30 % smaller O.D. by area than SAE spiral
- Twice the impulse/life – tested to 2,000,000 cycles
- Flex impulse tested, providing a hose superior in both performance and service life
- 30 % less hose weight than SAE spiral
- TC cover provides 80 times the abrasion resistance compared to Standard rubber cover hoses
- ST cover provides 450 times the abrasion resistance compared to Standard rubber cover hoses

Full Flange System

Provides full flange mounting option for ISO 6162-1 (35.0 MPa/5000 psi) and ISO 6162-2 (42.0 MPa/ 6000 psi) flanges – system flexibility reduces inventory investment.

The full flange system addresses the needs of customers by:

- Being easier to assemble
- Providing one-piece integrity
- Being easier to handle
- Being easier to route in tight spaces
- Enabling assemblies to be sent to customers with the flange in place
- Easing bent tube installation (displacement angle) with a freely rotating flange



The full flange system can be used repeatedly because of its patent-pending attachment system – the flange is not permanently locked onto the fitting.

- This is not a captive flange – it can easily be removed
- Flange can be reused if necessary
- Flange is not scrapped on a mis-crimp

Fitting Configuration

This fitting configuration is specifically designed for Parker's full flange system, and will accept either a ISO 6162-1 or ISO 6162-2 flange. The X5, X7 and X9 fittings are designed to work with all Parkrimp crimpers. These fittings can replace multiple existing fittings and help to reduce inventory.

Reduction of Inventory

Parker's full flange system requires less inventory than the existing split flange system.

By using the new X5, X7 and X9 fittings, distributors can streamline inventory and can still respond to customer needs. Before the introduction of the full flange system, distributors needed to stock both ISO 6162 fittings to be prepared.

For more information about Full Flange System please refer to pages *Dd-18, Dd-19, Df-19, Df-20, Eb-4 and Eb-5*



1X577-20-20

Straight
ISO 6162-1 or ISO 6162-2 fitting
Alternative to 15, 4A and 6A

1X777-20-20

45°
ISO 6162-1 or ISO 6162-2 fitting
Alternative to 17, 4F and 6F

1X977-20-20

90°
ISO 6162-1 or ISO 6162-2 fitting
Alternative to 19, 4N and 6N

High Pressure GLOBALCORE™

Hoses			Page
Best	722 <i>No-Skive</i>	Standard	Daa-1
Best	722TC <i>No-Skive</i>	High abrasion resistance	Daa-2
Best	722ST <i>No-Skive</i>	Extreme abrasion resistance	Daa-3
Best	787 <i>No-Skive</i>	Compact Spiral	Daa-4
Best	787TC <i>No-Skive</i>	Compact Spiral – High abrasion resistance	Daa-5
Best	787ST <i>No-Skive</i>	Compact Spiral – Extreme abrasion resistance	Daa-6
Best	797 <i>No-Skive</i>	Compact Spiral	Daa-7
Best	797TC <i>No-Skive</i>	Compact Spiral – High abrasion resistance	Daa-8
Best	797ST <i>No-Skive</i>	Compact Spiral – Extreme abrasion resistance	Daa-9

Fittings Series	77
Chapter	Dd
DIN – Metric	1 – 4
BSP	5 – 6
SAE	7 – 9
Flange	10 – 20
ORFS	21 – 23
French Standard	24
Special Fittings	25

Parkrimp

Standard

722 **Best**

Daa-1 

No-Skive GlobalCore
Exceeds ISO 18752-BC

High abrasion resistance

722TC **Best**

Daa-2 

No-Skive GlobalCore Tough Cover
Supérieur à ISO 18752-BC

Extreme abrasion resistance

722ST **Best**

Daa-3 

No-Skive GlobalCore Super Tough
Exceeds ISO 18752-BC

Compact Spiral

787 **Best**

Daa-4 

No-Skive GlobalCore Compact Spiral™
Sizes -4 to -6 exceed ISO 18752-AC

797 **Best**

Daa-7 

No-Skive GlobalCore Compact Spiral™
Size -4 exceeds ISO 18752-AC

Compact Spiral – High abrasion resistance

787TC **Best**

Daa-5 

No-Skive GlobalCore Compact Spiral™
Tough Cover

797TC **Best**

Daa-8 

No-Skive GlobalCore Compact Spiral™
Tough Cover

Compact Spiral – Extreme abrasion resistance

787ST **Best**

Daa-6 

No-Skive GlobalCore Compact Spiral™
Super Tough

797ST **Best**

Daa-9 

No-Skive GlobalCore Compact Spiral™
Super Tough

722

No-Skive GlobalCore

Exceeds ISO 18752-BC

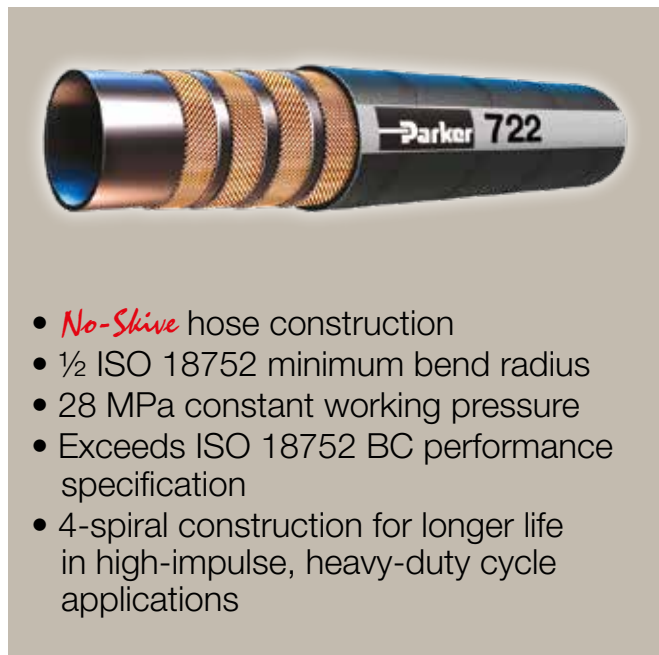

- *No-Skive* hose construction
- ½ ISO 18752 minimum bend radius
- 28 MPa constant working pressure
- Exceeds ISO 18752 BC performance specification
- 4-spiral construction for longer life in high-impulse, heavy-duty cycle applications

Primary Applications

General high pressure hydraulic applications

Applicable Specifications

Exceed ISO 18752-BC

Construction

Inner tube: Synthetic rubber
Reinforcement: Four spiral high-tensile steel wire
Cover: Synthetic rubber

Temperature Range -40 °C up to +100 °C

Exception: Air max. +70 °C
Water max. +85 °C

Recommended Fluids

Hydraulic fluids on a mineral-oil basis, water-glycol and lubricating oils, air and water. For air and gas applications with a pressure exceeding 1.7 MPa, the cover must be pin-pricked. Consult the chemical compatibility section on pages **Ab-26** to **Ab-34** for more detailed information.

Fitting Series



Series 43 you'll find in the Medium Pressure chapter Cb

Part Number	Hose I.D.				Hose O.D. mm	Pressure Rating				min. bend radius mm	weight kg
	DN	Inch	Size	mm		max. working pressure MPa	psi	min. burst pressure MPa	psi		
722-6	10	3/8	-6	9.5	19.9	28.0	4000	112.0	16000	65	0.60
722-8	12	1/2	-8	12.7	22.7	28.0	4000	112.0	16000	90	0.80
722-10	16	5/8	-10	15.9	26.4	28.0	4000	112.0	16000	100	1.10
722-12	19	3/4	-12	19.1	30.7	28.0	4000	112.0	16000	120	1.40
722-16	25	1	-16	25.4	37.8	28.0	4000	112.0	16000	150	1.99

The combination of high temperature and high pressure could reduce the hose life.

Hose layline example



722TC

No-Skive GlobalCore Tough Cover

Exceeds ISO 18752-BC

Primary Applications

General high pressure hydraulic applications

Type Approvals

Details please find on pages **Ab-16** to **Ab-19**

Applicable Specifications

SAE 100R12 – EN 856 Type R12 –

ISO 3862 Type R12

Construction

- Inner tube: Nitrile (NBR)
- Reinforcement: Four spiral high-tensile steel wire
- Cover: Highly abrasion resistance
MSHA approved synthetic rubber

Temperature Range -40 °C up to +125 °C

Exception: Air max. +70 °C

Water max. +85 °C

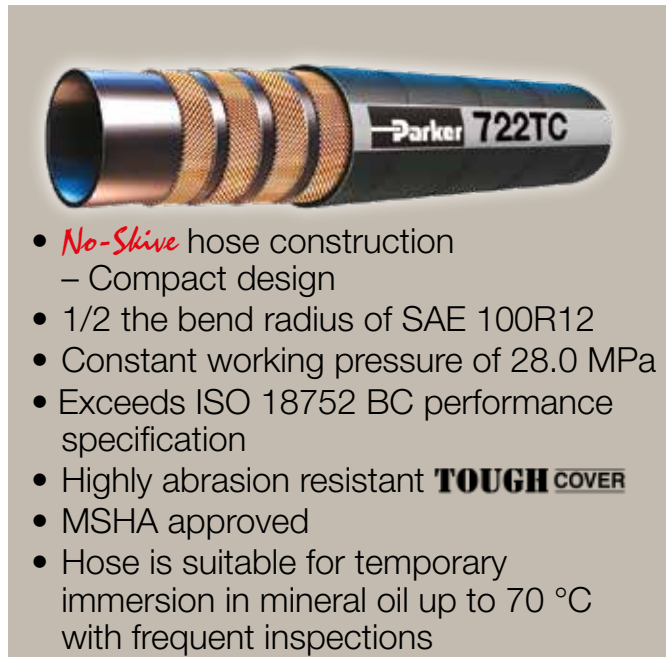

- **No-Skive** hose construction
– Compact design
- 1/2 the bend radius of SAE 100R12
- Constant working pressure of 28.0 MPa
- Exceeds ISO 18752 BC performance specification
- Highly abrasion resistant **TOUGH COVER**
- MSHA approved
- Hose is suitable for temporary immersion in mineral oil up to 70 °C with frequent inspections

Recommended Fluids

Hydraulic fluids on a mineral-oil basis, water-glycol and lubricating oils, air and water. For air and gas applications with a pressure exceeding 1.7 MPa, the cover must be pin-pricked. Consult the chemical compatibility section on pages **Ab-26** to **Ab-34** for more detailed information.

Fitting Series



Series 43 you'll find in the Medium Pressure chapter Cb

Part Number	Hose I.D.				Hose O.D. mm	Pressure Rating				min. bend radius mm	weight kg
	DN	Inch	Size	mm		max. working pressure MPa	psi	min. burst pressure MPa	psi		
722TC-6	10	3/8	-6	9.5	19.9	28.0	4000	112.0	16000	65	0.60
722TC-8	12	1/2	-8	12.7	22.7	28.0	4000	112.0	16000	90	0.80
722TC-10	16	5/8	-10	15.9	26.4	28.0	4000	112.0	16000	100	1.10
722TC-12	19	3/4	-12	19.1	30.7	28.0	4000	112.0	16000	120	1.40
722TC-16	25	1	-16	25.4	37.8	28.0	4000	112.0	16000	150	1.99

Replace the hose when any deformation or damage on the hose cover are visible.
The combination of high temperature and high pressure could reduce the hose life.

Hose layline example

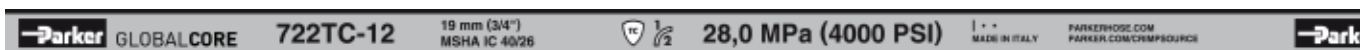

722ST

No-Skive GlobalCore Super Tough

Exceeds ISO 18752-BC



- *No-Skive* hose construction
- ½ ISO 18752 minimum bend radius
- 28 MPa constant working pressure
- Exceeds ISO 18752 BC performance specification
- Extreme abrasion resistant **SUPER TOUGH** cover
- 4-spiral construction for longer life in high-impulse, heavy-duty cycle applications

Primary Applications

General high pressure hydraulic applications

Applicable Specifications

Exceeds ISO 18752-BC

Construction

- Inner tube: Synthetic rubber
- Reinforcement: Four spiral high-tensile steel wire
- Cover: Synthetic rubber with a special polyethylene coating

Temperature Range -40 °C up to +125 °C

Exception: Air max. +70 °C

Water max. +85 °C

Recommended Fluids

Hydraulic fluids on a mineral-oil basis, water-glycol and lubricating oils, air and water. For air and gas applications with a pressure exceeding 1.7 MPa, the cover must be pin-pricked. Consult the chemical compatibility section on pages **Ab-26** to **Ab-34** for more detailed information.

Fitting Series



Series 43 you'll find in the Medium Pressure chapter Cb

Part Number	Hose I.D.				Hose O.D. mm	Pressure Rating				min. bend radius mm	weight kg
	DN	Inch	Size	mm		max. working pressure MPa	psi	min. burst pressure MPa	psi		
722ST-6	10	3/8	-6	9.5	19.9	28.0	4000	112.0	16000	65	0.60
722ST-8	12	1/2	-8	12.7	22.7	28.0	4000	112.0	16000	90	0.80
722ST-10	16	5/8	-10	15.9	26.4	28.0	4000	112.0	16000	100	1.10
722ST-12	19	3/4	-12	19.1	30.7	28.0	4000	112.0	16000	120	1.40
722ST-16	25	1	-16	25.4	37.8	28.0	4000	112.0	16000	150	1.99

The combination of high temperature and high pressure could reduce the hose life.

Hose layline example



787

No-Skive GlobalCore Compact Spiral™

Sizes -4 to -6 exceed ISO 18752-AC
 Sizes -8 to -32 exceed ISO 18752-BC



- 1/2 the bend radius of SAE 100R13
- Constant working pressure of 35.0 MPa
- Reduced O.D. and new construction lead to superior flexibility
- 1/3 less effort to bend
- Weight reduction – up to 26 %

Primary Applications

On- & offshore, construction, injection moulding, mining

Applicable Specifications

Exceeds ISO 18752-AC/BC

Construction

Inner tube: Proprietary synthetic rubber
 Reinforcement: Two braid steel wire for sizes -4 to -6,
 four or six compact spiral steel wire
 for sizes - 8 to -32
 Cover: Synthetic rubber

Recommended Fluids

Petroleum based hydraulic fluids and lubricating oils.
 Wide Compatibility exceeding Column III, with additional
 chemical resistance, especially for diesel and biodiesel.
 Consult the chemical compatibility section on
 pages **Ab-26 to Ab-34** for more detailed information.

Temperature Range -40 °C up to +100 °C

Exception: Air max. +70 °C
 Water max. +85 °C

Fitting Series

Series 43/48 for sizes -4 and -6
 Series 77 for sizes -8 up to -32



Part Number	Hose I.D.				Hose O.D. mm	Pressure Rating				min. bend radius mm	weight kg
	DN	Inch	Size	mm		max. working pressure MPa	psi	min. burst pressure MPa	psi		
787-4	6	1/4	4	6.3	13.0	35.0	5000	140.0	20000	50	0.31
787-6	10	3/8	-6	10.0	17.2	35.0	5000	140.0	20000	63	0.42
787-8	12	1/2	-8	12.7	21.1	35.0	5000	140.0	20000	90	0.67
787-10	16	5/8	-10	15.9	23.9	35.0	5000	140.0	20000	100	0.80
787-12	19	3/4	-12	19.1	27.9	35.0	5000	140.0	20000	120	1.16
787-16	25	1	-16	25.4	35.7	35.0	5000	140.0	20000	150	1.74
787-20	31	1 1/4	-20	31.8	44.9	35.0	5000	140.0	20000	210	2.89
787-24	38	1 1/2	-24	38.1	52.8	35.0	5000	140.0	20000	255	3.96
787-32	51	2	-32	50.8	67.6	35.0	5000	140.0	20000	318	6.50

Replace the hose when any deformation or damage on the hose cover are visible.
 The combination of high temperature and high pressure could reduce the hose life.

Hose layline example

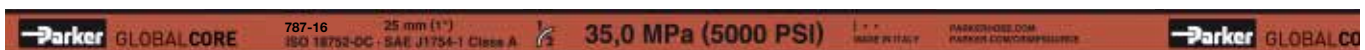

787TC

No-Skive GlobalCore Compact Spiral™

Tough Cover

Sizes -4 to -6 exceed ISO 18752-AC
Sizes -8 to -32 exceed ISO 18752-DC

Primary Applications

On- & offshore, construction, injection moulding, mining

Type Approvals

Details please find on pages **Ab-16** to **Ab-19**

Applicable Specifications

Exceeds SAE 100R13 – ISO 3862 Type R13 –
EN 856 Type R13 – ISO 18752-AC/DC

Construction

Inner tube: Proprietary synthetic rubber
Reinforcement: Two braid steel wire for sizes -4 to -6,
four or six compact spiral steel wire
for sizes - 8 to -32
Cover: Highly abrasion resistance
MSHA approved synthetic rubber

Temperature Range -40 °C up to +125 °C
(sizes -4 to -6 up to +100 °C)

Exception: Air max. +70 °C
Water max. +85 °C



- 1/2 the bend radius of SAE 100R13
- Constant working pressure of 35.0 MPa
- Reduced O.D. and new construction lead to superior flexibility
- 1/3 less effort to bend
- Weight reduction – up to 26 %
- Highly abrasion resistant **TOUGH COVER**
- MSHA approved
- Hose is suitable for temporary immersion in mineral oil up to 70 °C with frequent inspections

Recommended Fluids

Petroleum based hydraulic fluids and lubricating oils.
Wide Compatibility exceeding Column III, with additional chemical resistance, especially for diesel and biodiesel.
Consult the chemical compatibility section on pages **Ab-26** to **Ab-34** for more detailed information.

Fitting Series

Series 43/48 for sizes -4 and -6



Series 77 for sizes -8 up to -32

Part Number	Hose I.D.				Hose O.D. mm	Pressure Rating				min. bend radius mm	weight kg
	DN	Inch	Size	mm		max. working pressure MPa	psi	min. burst pressure MPa	psi		
787TC-4	6	1/4	4	6.3	13.0	35.0	5000	140.0	20000	50	0.31
787TC-6	10	3/8	-6	10.0	17.2	35.0	5000	140.0	20000	63	0.42
787TC-8	12	1/2	-8	12.7	21.1	35.0	5000	140.0	20000	90	0.67
787TC-10	16	5/8	-10	15.9	23.9	35.0	5000	140.0	20000	100	0.80
787TC-12	19	3/4	-12	19.1	27.9	35.0	5000	140.0	20000	120	1.16
787TC-16	25	1	-16	25.4	35.7	35.0	5000	140.0	20000	150	1.74
787TC-20	31	1 1/4	-20	31.8	44.9	35.0	5000	140.0	20000	210	2.89
787TC-24	38	1 1/2	-24	38.1	52.8	35.0	5000	140.0	20000	255	3.96
787TC-32	51	2	-32	50.8	67.6	35.0	5000	140.0	20000	318	6.50

Replace the hose when any deformation or damage on the hose cover are visible.
The combination of high temperature and high pressure could reduce the hose life.

Hose layline example



787ST

No-Skive GlobalCore Compact Spiral™

Super Tough

Sizes -4 to -6 exceed ISO 18752-AC
Sizes -8 to -32 exceed ISO 18752-DC

Primary Applications

On- & offshore, construction, injection moulding, mining

Type Approvals

Details please find on pages **Ab-16** to **Ab-19**

Applicable Specifications

Exceeds SAE 100R13 – ISO 3862 Type R13 –
EN 856 Type R13 – ISO 18752-AC/DC

Construction

Inner tube: Proprietary synthetic rubber
Reinforcement: Two braid steel wire for sizes -4 to -6,
four or six compact spiral steel wire
for sizes - 8 to -32
Cover: Synthetic rubber
with a special polyethylene coating

Temperature Range -40 °C up to +125 °C
(sizes -4 to -6 up to +100 °C)

Exception: Air max. +70 °C
Water max. +85 °C



- 1/2 the bend radius of SAE 100R13
 - Constant working pressure of 35.0 MPa
 - Reduced O.D. and new construction lead to superior flexibility
 - 1/3 less effort to bend
 - Weight reduction – up to 26 %
 - Extreme abrasion resistant
- SUPER TOUGH** cover

Recommended Fluids

Petroleum based hydraulic fluids and lubricating oils.
Wide Compatibility exceeding Column III, with additional
chemical resistance, especially for diesel and biodiesel.
Consult the chemical compatibility section on
pages **Ab-26** to **Ab-34** for more detailed information.

Fitting Series

Series 43/48 for sizes -4 and -6



Series 77 for sizes -8 up to -32



Part Number	Hose I.D.				Hose O.D. mm	Pressure Rating				min. bend radius mm	weight kg
	DN	Inch	Size	mm		max. working pressure MPa	psi	min. burst pressure MPa	psi		
787ST-4	6	1/4	4	6.3	13.0	35.0	5000	140.0	20000	50	0.31
787ST-6	10	3/8	-6	10.0	17.2	35.0	5000	140.0	20000	63	0.42
787ST-8	12	1/2	-8	12.7	21.1	35.0	5000	140.0	20000	90	0.67
787ST-10	16	5/8	-10	15.9	23.9	35.0	5000	140.0	20000	100	0.80
787ST-12	19	3/4	-12	19.1	27.9	35.0	5000	140.0	20000	120	1.16
787ST-16	25	1	-16	25.4	35.7	35.0	5000	140.0	20000	150	1.74
787ST-20	31	1 1/4	-20	31.8	44.9	35.0	5000	140.0	20000	210	2.89
787ST-24	38	1 1/2	-24	38.1	52.8	35.0	5000	140.0	20000	255	3.96
787ST-32	51	2	-32	50.8	67.6	35.0	5000	140.0	20000	318	6.50

Replace the hose when any deformation or damage on the hose cover are visible.
The combination of high temperature and high pressure could reduce the hose life.

Hose layline example



797

No-Skive GlobalCore Compact Spiral™

Size -4 exceeds ISO 18752-AC
Sizes -6 to -32 exceed ISO 18752-BC



- 1/2 the bend radius of SAE 100R15
- Constant working pressure of 42.0 MPa
- Reduced O.D. and new construction lead to superior flexibility
- 1/3 less effort to bend
- Weight reduction – up to 26 %

Primary Applications

On- & offshore, construction, injection moulding, mining

Applicable Specifications

Exceed ISO 18752-AC/CC/DC

Construction

Inner tube: Proprietary synthetic rubber
Reinforcement: Two braid steel wire for size -4,
four or six compact spiral steel wire
for sizes - 6 to -32
Cover: Synthetic rubber

Recommended Fluids

Petroleum based hydraulic fluids and lubricating oils.
Wide Compatibility exceeding Column III, with additional
chemical resistance, especially for diesel and biodiesel.
Consult the chemical compatibility section on
pages **Ab-26** to **Ab-34** for more detailed information.

Temperature Range -40 °C up to +100 °C
Exception: Air max. +70 °C
Water max. +85 °C

Fitting Series

Series 43/48 for size -4



Series 43 for size -6



Series 77 for sizes -8 up to -32



Part Number	Hose I.D.				Hose O.D. mm	Pressure Rating				min. bend radius mm	weight kg
	DN	Inch	Size	mm		max. working pressure MPa	psi	min. burst pressure MPa	psi		
797-4	6	1/4	4	6.3	13.0	42.0	6000	168.0	24000	50	0.31
797-6	10	3/8	-6	10.0	17.0	42.0	6000	168.0	24000	63	0.46
797-8	12	1/2	-8	12.7	21.1	42.0	6000	168.0	24000	100	0.67
797-10	16	5/8	-10	15.9	23.9	42.0	6000	168.0	24000	115	0.80
797-12	19	3/4	-12	19.1	27.9	42.0	6000	168.0	24000	135	1.16
797-16	25	1	-16	25.4	35.7	42.0	6000	168.0	24000	165	1.74
797-20	31	1 1/4	-20	31.8	44.9	42.0	6000	168.0	24000	225	2.89
797-24	38	1 1/2	-24	38.1	52.8	42.0	6000	168.0	24000	305	3.96
797-32	51	2	-32	50.8	67.6	42.0	6000	168.0	24000	380	6.50

Replace the hose when any deformation or damage on the hose cover are visible.
The combination of high temperature and high pressure could reduce the hose life.

Hose layline example



797TC

No-Skive GlobalCore Compact Spiral™

Tough Cover

Size -4 exceeds ISO 18752-AC
 Sizes -8 to -20 exceed ISO 18752-DC
 Sizes -6, -24, -32 exceed ISO 18752-CC

Primary Applications

On- & offshore, construction, injection moulding, mining

Type Approvals

Details please find on pages **Ab-16** to **Ab-19**

Applicable Specifications

Exceeds SAE 100R15 – ISO 3862 Type R15 –
 ISO 18752-AC/CC/DC

Construction

Inner tube: Proprietary synthetic rubber
 Reinforcement: Two braid steel wire for size -4,
 four or six compact spiral steel wire
 for sizes - 6 to -32
 Cover: Highly abrasion resistance
 MSHA approved synthetic rubber

Temperature Range -40 °C up to +125 °C
 (size -4 up to +100 °C)

Exception: Air max. +70 °C
 Water max. +85 °C

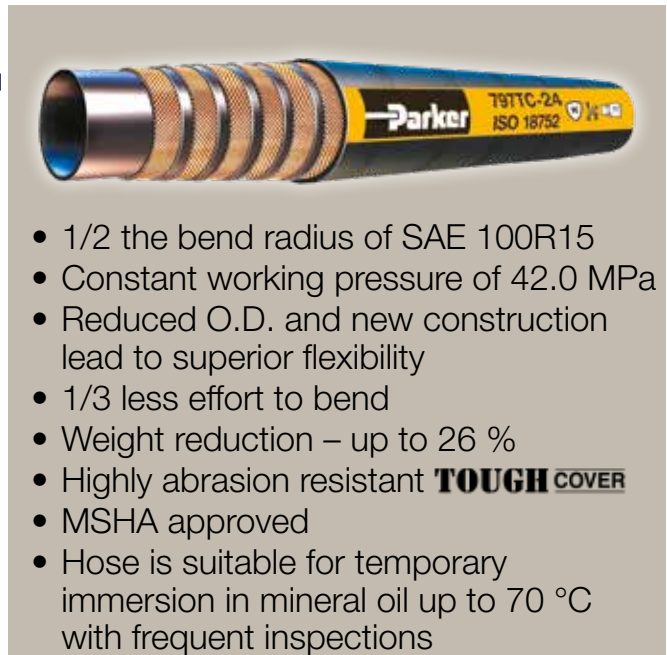

- 1/2 the bend radius of SAE 100R15
- Constant working pressure of 42.0 MPa
- Reduced O.D. and new construction lead to superior flexibility
- 1/3 less effort to bend
- Weight reduction – up to 26 %
- Highly abrasion resistant **TOUGH COVER**
- MSHA approved
- Hose is suitable for temporary immersion in mineral oil up to 70 °C with frequent inspections

Recommended Fluids

Petroleum based hydraulic fluids and lubricating oils.
 Wide Compatibility exceeding Column III, with additional chemical resistance, especially for diesel and biodiesel.
 Consult the chemical compatibility section on pages **Ab-26** to **Ab-34** for more detailed information.

Fitting Series

Series 43/48 for size-4



Series 43 for size -6



Series 77 for sizes -8 up to -32



Part Number	Hose I.D.				Hose O.D. mm	Pressure Rating				min. bend radius mm	weight kg
	DN	Inch	Size	mm		max. working pressure MPa	psi	min. burst pressure MPa	psi		
797TC-4	6	1/4	4	6.3	13.0	42.0	6000	168.0	24000	50	0.31
797TC-6	10	3/8	-6	10.0	17.0	42.0	6000	168.0	24000	63	0.46
797TC-8	12	1/2	-8	12.7	21.1	42.0	6000	168.0	24000	100	0.67
797TC-10	16	5/8	-10	15.9	23.9	42.0	6000	168.0	24000	115	0.80
797TC-12	19	3/4	-12	19.1	27.9	42.0	6000	168.0	24000	135	1.16
797TC-16	25	1	-16	25.4	35.7	42.0	6000	168.0	24000	165	1.74
797TC-20	31	1 1/4	-20	31.8	44.9	42.0	6000	168.0	24000	225	2.89
797TC-24	38	1 1/2	-24	38.1	52.8	42.0	6000	168.0	24000	305	3.96
797TC-32	51	2	-32	50.8	67.6	42.0	6000	168.0	24000	380	6.50

Replace the hose when any deformation or damage on the hose cover are visible.
 The combination of high temperature and high pressure could reduce the hose life.

Hose layline example



797ST

No-Skive GlobalCore Compact Spiral™

Super Tough

Size -4 exceeds ISO 18752-AC
 Sizes -8 to -20 exceed ISO 18752-DC
 Sizes -6, -24, -32 exceed ISO 18752-CC

Primary Applications

On- & offshore, construction, injection moulding, mining

Type Approvals

Details please find on pages **Ab-16** to **Ab-19**

Applicable Specifications

Exceeds SAE 100R15 – ISO 3862 Type R15 –
 ISO 18752-AC/CC/DC

Construction

Inner tube: Proprietary synthetic rubber
 Reinforcement: Two braid steel wire for size -4,
 four or six compact spiral steel wire
 for sizes - 6 to -32
 Cover: Synthetic rubber
 with a special polyethylene coating

Temperature Range -40 °C up to +125 °C
 (size -4 up to +100 °C)

Exception: Air max. +70 °C
 Water max. +85 °C



- 1/2 the bend radius of SAE 100R15
- Constant working pressure of 42.0 MPa
- Reduced O.D. and new construction lead to superior flexibility
- 1/3 less effort to bend
- Weight reduction – up to 26 %
- Extreme abrasion resistant

SUPER TOUGH cover

Recommended Fluids

Petroleum based hydraulic fluids and lubricating oils.
 Wide Compatibility exceeding Column III, with additional
 chemical resistance, especially for diesel and biodiesel.
 Consult the chemical compatibility section on
 pages **Ab-26** to **Ab-34** for more detailed information.

Fitting Series

Series 43/48 for size -4



Series 43 for size -6



Series 77 for sizes -8 up to -32



Part Number	Hose I.D.				Hose O.D. mm	Pressure Rating				min. bend radius mm	weight kg
	DN	Inch	Size	mm		max. working pressure MPa	psi	min. burst pressure MPa	psi		
797ST-4	6	1/4	4	6.3	13.0	42.0	6000	168.0	24000	50	0.31
797ST-6	10	3/8	-6	10.0	17.0	42.0	6000	168.0	24000	63	0.46
797ST-8	12	1/2	-8	12.7	21.1	42.0	6000	168.0	24000	100	0.67
797ST-10	16	5/8	-10	15.9	23.9	42.0	6000	168.0	24000	115	0.80
797ST-12	19	3/4	-12	19.1	27.9	42.0	6000	168.0	24000	135	1.16
797ST-16	25	1	-16	25.4	35.7	42.0	6000	168.0	24000	165	1.74
797ST-20	31	1 1/4	-20	31.8	44.9	42.0	6000	168.0	24000	225	2.89
797ST-24	38	1 1/2	-24	38.1	52.8	42.0	6000	168.0	24000	305	3.96
797ST-32	51	2	-32	50.8	67.6	42.0	6000	168.0	24000	380	6.50

Replace the hose when any deformation or damage on the hose cover are visible.
 The combination of high temperature and high pressure could reduce the hose life.

Hose layline example



High Pressure

Hoses		Page		
Parkrimp	371LT <i>No-Skive</i>	3-braids low temperature	Dab-1	
	372 <i>No-Skive</i>	3-braids standard	Dab-2	
	372RH <i>No-Skive</i>	3-braids railway	Dab-3	
	372TC <i>No-Skive</i>	3-braids high abrasion resistance	Dab-4	
	Good SX35 <i>No-Skive</i>	Standard	Dab-5	
	SX35LT <i>No-Skive</i>	Low temperature	Dab-6	
	Good SX35TC <i>No-Skive</i>	High abrasion resistance	Dab-7	
	Good SX42 <i>No-Skive</i>	Standard	Dab-8	
	SX42LT <i>No-Skive</i>	Low temperature	Dab-9	
	Good SX42TC <i>No-Skive</i>	High abrasion resistance	Dab-10	
	Better 701 <i>No-Skive</i>	Standard	Dab-11	
	701TC <i>No-Skive</i>	High abrasion resistance	Dab-12	
	Better 731 <i>No-Skive</i>	Standard	Dab-13	
	731TC <i>No-Skive</i>	High abrasion resistance	Dab-14	
	774 <i>No-Skive</i>	Phosphate Ester	Dab-15	
	797RH	Railway	Dab-16	
	F42 <i>No-Skive</i>	Phosphate Ester	Dab-17	
	ParLock	H29	Standard	Dab-18
		H29TC	High abrasion resistance	Dab-19
		H29ST	Extreme abrasion resistance	Dab-20
H31		Standard	Dab-21	
H31TC		High abrasion resistance	Dab-22	
H31ST		Extreme abrasion resistance	Dab-23	
R35		Standard	Dab-24	
R35TC/RS35TC-48		High abrasion resistance	Dab-25	
R42		Standard	Dab-26	
R42TC		High abrasion resistance	Dab-27	
R42ST		Extreme abrasion resistance	Dab-28	
R50TC/R56TC		High abrasion resistance	Dab-29	
BPK		Water-Blasting	Dab-30	
FA35		Firearmor Blowout Preventer	Dab-31	
RD35TC		High abrasion resistance	Dab-32	
CEM69TC		Cementing hose	Dab-33	

Fittings Series	Parkrimp			ParLock			
	70	73	77	VS	V4/V6	V5	WB
Chapter	Db	Dc	Dd	De	Df	Dg	Dh
Shell				1	1	1	1
DIN – Metric	1–4	1–4	1–4	2–5	2–5	2–3	2
BSP	5–7	5–6	5–6	6–7	6–8		3
SAE	8–10	7–9	7–9	8–10	9–11		4
Flange	11–14	10–15	10–20	11–13	12–22		
ORFS	15–17	16–18	21–23	14–15	23–25		
French Standard			24				
Others	18	19					
Special Fittings		20	25				

Parker Hannifin assumes no liability for typographical errors or other errors

Parkrimp

3-braids standard



3-braids low temperature



3-braids high abrasion resistance





3-braids railway



Parkrimp

Standard

<p>SX35 Good</p> <p>Dab-5 </p> <p><i>No-Skive Multispiral</i> ISO 3862 Type R13 – Parker Specifications</p>	<p>SX42 Good</p> <p>Dab-8 </p> <p><i>No-Skive Multispiral</i> ISO 3862 Type R15 – Parker Specifications</p>	<p>701 Better</p> <p>Dab-11 </p> <p><i>No-Skive Multispiral</i> Exceeds ISO 3862 Type 4SP – EN 856 Type 4SP</p>	<p>731 Better</p> <p>Dab-13 </p> <p><i>No-Skive Multispiral</i> Exceeds ISO 3862 Type 4SH – EN 856 Type 4SH</p>
---	---	--	---

Low temperature

<p>SX35LT</p> <p>Dab-6 </p> <p><i>No-Skive Multispiral</i> Parker Specification</p>	<p>SX42LT</p> <p>Dab-9 </p> <p><i>No-Skive Multispiral</i> Parker Specification</p>
---	---

Phosphate Ester

<p>774</p> <p>Dab-15 </p> <p><i>No-Skive Multispiral</i> For phosphate ester base fluids</p>	<p>F42</p> <p>Dab-17 </p> <p><i>No-Skive Multispiral</i> For phosphate ester base fluids</p>
---	---

High abrasion resistance

<p>SX35TC Good</p> <p>Dab-7 </p> <p><i>No-Skive Multispiral Tough Cover</i> ISO 3862 Type R13 – Parker Specifications</p>	<p>SX42TC Good</p> <p>Dab-10 </p> <p><i>No-Skive Multispiral Tough Cover</i> ISO 3862 Type R15 – Parker Specifications</p>	<p>701TC</p> <p>Dab-12 </p> <p><i>No-Skive Multispiral Tough Cover</i> ISO 3862 Type 4SP – EN 856 Type 4SP</p>	<p>731TC</p> <p>Dab-14 </p> <p><i>No-Skive Multispiral</i> ISO 3862 Type 4SH – EN 856 Type 4SH</p>
---	--	---	--

Railway

797RH

Dab-16 

No-Skive Compact Spiral™
Fire-retardant cover

Hose

ParLock

Standard

<p>H29 Dab-18</p>  <p>ParLock Multispiral Exceeds ISO 3862 Type 4SH – EN 856 Type 4SH</p>	<p>H31 Dab-21</p>  <p>ParLock Multispiral Exceeds ISO 3862 Type 4SP – EN 856 Type 4SP</p>	<p>R35 Dab-24</p>  <p>ParLock Multispiral Exceeds ISO 3862 Type R13 – Parker Specifications</p>	<p>R42 Dab-26</p>  <p>ParLock Multispiral Exceeds ISO 3862 Type R15 – Parker Specifications</p>
--	--	---	--

High abrasion resistance

<p>H29TC Dab-19</p>  <p>ParLock Multispiral Exceeds ISO 3862 Type 4SH – EN 856 Type 4SH</p>	<p>H31TC Dab-22</p>  <p>ParLock Multispiral Exceeds ISO 3862 Type 4SP – EN 856 Type 4SP</p>	<p>R35TC/RS35TC-48 Dab-25</p>  <p>ParLock Multispiral Exceeds ISO 3862 Type R13 – Parker Specifications</p>	<p>R42TC Dab-27</p>  <p>ParLock Multispiral Exceeds ISO 3862 Type R15 – Parker Specifications</p>
<p>R50TC/R56TC Dab-29</p>  <p>ParLock Multispiral Exceeds ISO 3862 Type R15 – Parker Specifications</p>	<p>RD35TC Dab-32</p>  <p>ParLock Multispiral Drilling Application API 7K Grade D/ISO 14693</p>	<p>CEM69TC Dab-33</p>  <p>Parlock Multispiral Cementing Hose According to API 7K</p>	

Extreme abrasion resistance

<p>H29ST Dab-20</p>  <p>ParLock Multispiral Exceeds ISO 3862 Type 4SH – EN 856 Type 4SH</p>	<p>H31ST Dab-23</p>  <p>ParLock Multispiral Exceeds ISO 3862 Type 4SP – EN 856 Type 4SP</p>	<p>R42ST Dab-28</p>  <p>ParLock Multispiral Exceeds ISO 3862 Type R15 – Parker Specifications</p>
--	--	---

Water-Blasting

BPK
Dab-30



Blastopak ParLock Multispiral
DIN EN 1829-2

Firearmor Blowout Preventer

FA35
Dab-31



**ParLock Multispiral Firearmor Blowout
Preventer Application**
Meets API 16D – Lloyd's 1000/499 fire test

371LT

No-Skive Compact

3-wire braid low-temperature compact hose with 4SP working pressures

Primary Applications

Mobile applications in low temperature environments:
Forestry machines, refrigerated warehouses

Applicable Specifications

Parker Specification

Construction

Inner tube: Synthetic rubber
Reinforcement: Three high-tensile steel wire braids
Cover: Synthetic rubber

Temperature Range -50 °C up to +100 °C

Exception: Air max. +70 °C
Water max. +85 °C



- *No-Skive* hose construction – Compact design
- Excellent ozone resistance
- Temperature range from -50 °C up to +100 °C

Recommended Fluids

Hydraulic fluids on a mineral-oil basis, water-glycol and lubricating oils, air and water. For air and gas applications with a pressure exceeding 1.7 MPa, the cover must be pin-pricked. Consult the chemical compatibility section on pages **Ab-26** to **Ab-34** for more detailed information.

Fitting Series



Part Number	Hose I.D.				Hose O.D. mm	Pressure Rating				min. bend radius mm	weight kg
	DN	Inch	Size	mm		max. working pressure MPa	psi	min. burst pressure MPa	psi		
371LT-6	10	3/8	-6	9.5	21.4	44.5	6500	178.0	25800	120	0.73
371LT-8	12	1/2	-8	12.7	24.6	41.5	6000	166.0	24000	160	0.90
371LT-10	16	5/8	-10	15.9	28.2	35.0	5000	140.0	20000	210	1.09
371LT-12	19	3/4	-12	19.1	32.2	35.0	5000	140.0	20000	260	1.36
371LT-16	25	1	-16	25.4	39.7	28.0	4000	112.0	16000	310	1.78

The combination of high temperature and high pressure could reduce the hose life.

Hose layline example



372

No-Skive Compact

3-wire braid compact hose with
4SP working pressures

Primary Applications

General high pressure small bending radii hydraulic applications

Type Approvals

Details please find on pages **Ab-16** to **Ab-19**

Applicable Specifications

Parker Specification

Construction

Inner tube: Nitrile (NBR)
Reinforcement: Three high-tensile steel wire braids
Cover: Synthetic rubber

Temperature Range -40 °C up to +100 °C

Exception: Air max. +70 °C

Water max. +85 °C



- *No-Skive* hose construction – Compact design
- Nitrile (NBR) inner tube for extended fluid compatibility

Recommended Fluids

Hydraulic fluids on a mineral-oil basis, water-glycol and lubricating oils, air and water. For air and gas applications with a pressure exceeding 1.7 MPa, the cover must be pin-pricked. Consult the chemical compatibility section on pages **Ab-26** to **Ab-34** for more detailed information.

Fitting Series



Part Number	Hose I.D.				Hose O.D. mm	Pressure Rating				min. bend radius mm	weight kg
	DN	Inch	Size	mm		max. working pressure		min. burst pressure			
						MPa	psi	MPa	psi		
372-6	10	3/8	-6	9.5	21.4	44.5	6500	178.0	25800	120	0.73
372-8	12	1/2	-8	12.7	24.6	41.5	6000	166.0	24000	160	0.90
372-10	16	5/8	-10	15.9	28.2	35.0	5000	140.0	20000	210	1.09
372-12	19	3/4	-12	19.1	32.2	35.0	5000	140.0	20000	260	1.36
372-16	25	1	-16	25.4	39.7	28.0	4000	112.0	16000	310	1.78

The combination of high temperature and high pressure could reduce the hose life.

Hose layline example



372RH

No-Skive Compact

3-wire braid with fire-retardant cover

Primary Applications

Dynamic and static high-pressure hydraulic systems

Type Approvals

Details please find on pages **Ab-16** to **Ab-19**

Applicable Specifications

Parker Specification

Working pressure and O.D. to EN 856-4SP

Construction

Inner tube: Nitrile (NBR)

Reinforcement: Three high-tensile steel wire braids

Cover: Fire retardant synthetic rubber

Temperature Range -40 °C up to +100 °C

Exception: Air max. +70 °C

Water max. +85 °C



- **No-Skive** hose construction
- Nitrile (NBR) inner tube – high chemical resistance
- Small bend radii
- Fire-retardant cover
- Railway approved:
 - European Standard EN45545 HL2 for R22 (internal) and HL3 for R23 (external)
 - ISO 15540

Recommended Fluids

Hydraulic fluids on a mineral-oil basis, water-glycol and lubricating oils, air and water. For air and gas applications with a pressure exceeding 1.7 MPa, the cover must be pin-pricked. Consult the chemical compatibility section on pages **Ab-26** to **Ab-34** for more detailed information.

Fitting Series



Part Number	Hose I.D.				Hose O.D. mm	Pressure Rating				min. bend radius mm	weight kg
	DN	Inch	Size	mm		max. working pressure MPa	psi	min. burst pressure MPa	psi		
372RH-6	10	3/8	-6	9.5	21.4	44.5	6500	178.0	25800	120	0.73
372RH-8	12	1/2	-8	12.7	24.6	41.5	6000	166.0	24000	160	0.90
372RH-10	16	5/8	-10	15.9	28.2	35.0	5000	140.0	20000	210	1.09
372RH-12	19	3/4	-12	19.1	32.2	35.0	5000	140.0	20000	260	1.36
372RH-16	25	1	-16	25.4	39.7	28.0	4000	112.0	16000	310	1.78

The combination of high temperature and high pressure could reduce the hose life.

Hose layline example

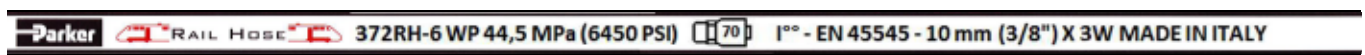

372TC

No-Skive Compact

3-wire braid compact hose with 4SP working pressures

Primary Applications

General high pressure hydraulic applications (typically in the mobile industry)

Type Approvals

Details please find on pages **Ab-16** to **Ab-19**

Applicable Specifications

Parker Specification – working pressures and outside diameters according to EN 856-4SP

Construction

Inner tube: Nitrile (NBR)
Reinforcement: Three high-tensile steel wire braids
Cover: Highly abrasion resistance
MSHA approved synthetic rubber

Temperature Range -40 °C up to +100 °C

Exception: Air max. +70 °C
Water max. +85 °C

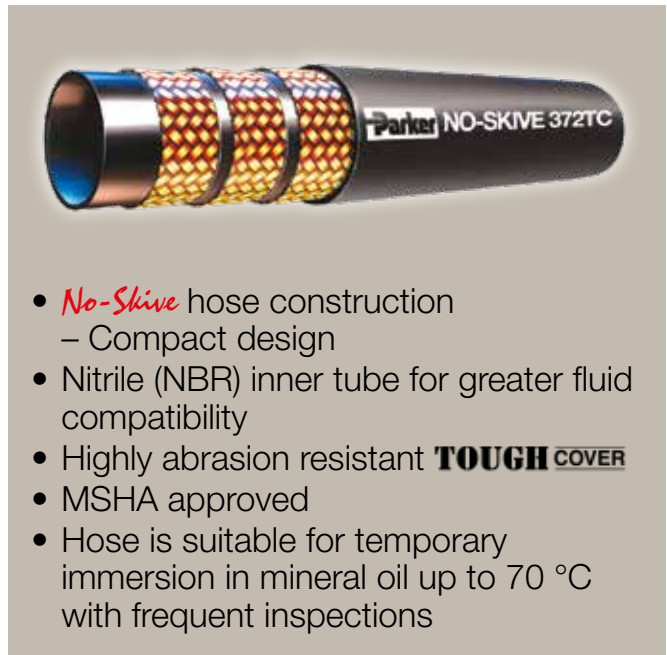

- *No-Skive* hose construction – Compact design
- Nitrile (NBR) inner tube for greater fluid compatibility
- Highly abrasion resistant **TOUGH COVER**
- MSHA approved
- Hose is suitable for temporary immersion in mineral oil up to 70 °C with frequent inspections

Recommended Fluids

Hydraulic fluids on a mineral-oil basis, water-glycol and lubricating oils, air and water. For air and gas applications with a pressure exceeding 1.7 MPa, the cover must be pin-pricked. Consult the chemical compatibility section on pages **Ab-26** to **Ab-34** for more detailed information.

Fitting Series



Part Number	Hose I.D.				Hose O.D. mm	Pressure Rating				min. bend radius mm	weight kg
	DN	Inch	Size	mm		max. working pressure MPa	psi	min. burst pressure MPa	psi		
372TC-6	10	3/8	-6	9.5	21.4	44.5	6500	178.0	25800	120	0.73
372TC-8	12	1/2	-8	12.7	24.6	41.5	6000	166.0	24000	160	0.90
372TC-10	16	5/8	-10	15.9	28.2	35.0	5000	140.0	20000	210	1.09
372TC-12	19	3/4	-12	19.1	32.2	35.0	5000	140.0	20000	260	1.36
372TC-16	25	1	-16	25.4	39.7	28.0	4000	112.0	16000	310	1.78

Replace the hose when any deformation or damage on the hose cover are visible. The combination of high temperature and high pressure could reduce the hose life.

Hose layline example



SX35

No-Skive Multispiral

ISO 3862 Type R13 – Parker Specifications



- *No-Skive* hose construction
- High performance
- Reinforcement of four spiral high-tensile steel wire
- Constant working pressure of 35.0 MPa
- Temperature range up to +125 °C

Primary Applications

General high pressure hydraulic applications

Applicable Specifications

ISO 3862 Type R13 – Parker Specification

Construction

Inner tube: Synthetic rubber
 Reinforcement: Four spiral high-tensile steel wire
 Cover: Synthetic rubber

Temperature Range -40 °C up to +125 °C

Exception: Air max. +70 °C
 Water max. +85 °C

Recommended Fluids

Hydraulic fluids on a mineral-oil basis, water-glycol and lubricating oils, air and water. For air and gas applications with a pressure exceeding 1.7 MPa, the cover must be pin-pricked. Consult the chemical compatibility section on pages **Ab-26** to **Ab-34** for more detailed information.

Fitting Series



Part Number	Hose I.D.				Hose O.D. mm	Pressure Rating				min. bend radius mm	weight kg
	DN	Inch	Size	mm		max. working pressure MPa	psi	min. burst pressure MPa	psi		
SX35-12	20	3/4	-12	19.1	32.4	35.0	5000	140.0	20000	240	1.72
SX35-16	25	1	-16	25.4	38.2	35.0	5000	140.0	20000	300	2.14
SX35-20	32	1 1/4	-20	31.5	46.3	35.0	5000	140.0	20000	420	2.96

The combination of high temperature and high pressure could reduce the hose life.

Hose layline example

Parker NO-SKIVE - SX35-12 WP 35,0 MPa (5000 PSI) 1° ISO 3862 4SP / R13 - 19 mm (3/4") MADE IN ITALY



SX35LT

No-Skive Multispiral

Parker Specification

Primary Applications

General high pressure hydraulic applications for very low temperature environments

Applicable Specifications

Parker Specification

Construction

Inner tube: Synthetic rubber
Reinforcement: Four high-tensile steel wires
Cover: Synthetic rubber

Temperature Range -57 °C up to +100 °C

Exception: Air max. +70 °C

Water max. +85 °C



- **No-Skive** hose construction
- Superior performances in extreme cold conditions
- Reinforcement of four high tensile steel wires
- Constant working pressure of 35.0 MPa
- Low Temperature range up to -57 °C (-70 °F)

Recommended Fluids

Hydraulic fluids on a mineral-oil basis, water-glycol and lubricating oils, air and water. For air and gas applications with a pressure exceeding 1.7 MPa, the cover must be pin-pricked. Consult the chemical compatibility section on pages **Ab-26** to **Ab-34** for more detailed information.

Fitting Series



Part Number	Hose I.D.				Hose O.D. mm	Pressure Rating				min. bend radius mm	weight kg
	DN	Inch	Size	mm		max. working pressure		min. burst pressure			
						MPa	psi	MPa	psi		
SX35LT-12	20	3/4	-12	19.1	32.4	35.0	5000	140.0	20000	240	1.72
SX35LT-16	25	1	-16	25.4	38.2	35.0	5000	140.0	20000	300	2.14
SX35LT-20	32	1 1/4	-20	31.5	46.3	35.0	5000	140.0	20000	420	2.96

The combination of high temperature and high pressure could reduce the hose life.

Hose layline example



SX35TC

No-Skive Multispiral Tough Cover

ISO 3862 Type R13 – Parker Specifications



- *No-Skive* hose construction
- High performance
- Highly abrasion resistant **TOUGH COVER**
- MSHA approved
- Reinforcement of four spiral high-tensile steel wire
- Constant working pressure of 35.0 MPa
- Temperature range up to +125 °C

Primary Applications

General high pressure hydraulic applications

Applicable Specifications

ISO 3862 Type R13 – Parker Specification

Construction

Inner tube: Synthetic rubber
 Reinforcement: Four spiral high-tensile steel wire
 Cover: Highly abrasion resistance
 MSHA approved synthetic rubber

Recommended Fluids

Hydraulic fluids on a mineral-oil basis, water-glycol and lubricating oils, air and water. For air and gas applications with a pressure exceeding 1.7 MPa, the cover must be pin-pricked. Consult the chemical compatibility section on pages **Ab-26** to **Ab-34** for more detailed information.

Temperature Range -40 °C up to +125 °C

Exception: Air max. +70 °C

Water max. +85 °C

Fitting Series



Part Number	Hose I.D.				Hose O.D. mm	Pressure Rating				min. bend radius mm	weight kg
	DN	Inch	Size	mm		max. working pressure MPa	psi	min. burst pressure MPa	psi		
SX35TC-12	20	3/4	-12	19.1	32.4	35.0	5000	140.0	20000	240	1.72
SX35TC-16	25	1	-16	25.4	38.2	35.0	5000	140.0	20000	300	2.14
SX35TC-20	32	1 1/4	-20	31.5	46.3	35.0	5000	140.0	20000	420	2.96

The combination of high temperature and high pressure could reduce the hose life.

Hose layline example



SX42

No-Skive Multispiral

ISO 3862 Type R15 – Parker Specifications



- *No-Skive* hose construction
- High performance
- Reinforcement of four or six spiral high-tensile steel wire
- Constant working pressure of 42.0 MPa
- Temperature range up to +125 °C

Primary Applications

General high pressure hydraulic applications

Applicable Specifications

ISO 3862 Type R15 – Parker Specification

Construction

Inner tube: Synthetic rubber
 Reinforcement: Four or six spiral high-tensile steel wire
 Cover: Synthetic rubber

Temperature Range -40 °C up to +125 °C

Exception: Air max. +70 °C

Water max. +85 °C

Recommended Fluids

Hydraulic fluids on a mineral-oil basis, water-glycol and lubricating oils, air and water. For air and gas applications with a pressure exceeding 1.7 MPa, the cover must be pin-pricked. Consult the chemical compatibility section on pages **Ab-26** to **Ab-34** for more detailed information.

Fitting Series

Size -12

Size -16 and -20



Part Number	Hose I.D.				Hose O.D. mm	Pressure Rating				min. bend radius mm	weight kg
	DN	Inch	Size	mm		max. working pressure MPa	psi	min. burst pressure MPa	psi		
SX42-12	20	3/4	-12	19.1	32.4	42.0	6000	168.0	24000	260	1.72
SX42-16	25	1	-16	25.4	38.2	42.0	6000	168.0	24000	330	1.74
SX42-20	32	1 1/4	-20	31.5	46.3	42.0	6000	168.0	24000	400	2.98

The combination of high temperature and high pressure could reduce the hose life.

Hose layline example



SX42LT

No-Skive Multispiral

Parker Specification



- **No-Skive** hose construction
- Superior performances in extreme cold conditions
- Reinforcement of four or six high tensile steel wires
- Constant working pressure of 42.0 MPa
- Low Temperature range up to -57 °C (-70 °F)

Primary Applications

General high pressure hydraulic applications for very low temperature environments

Applicable Specifications

Parker Specification

Construction

Inner tube: Synthetic rubber
Reinforcement: Four or six spiral high-tensile steel wires
Cover: Synthetic rubber

Temperature Range -57 °C up to +100 °C

Exception: Air max. +70 °C
Water max. +85 °C

Recommended Fluids

Hydraulic fluids on a mineral-oil basis, water-glycol and lubricating oils, air and water. For air and gas applications with a pressure exceeding 1.7 MPa, the cover must be pin-pricked. Consult the chemical compatibility section on pages **Ab-26** to **Ab-34** for more detailed information.

Fitting Series

Size -12

Size -16 and -20



Part Number	Hose I.D.				Hose O.D. mm	Pressure Rating				min. bend radius mm	weight kg
	DN	Inch	Size	mm		max. working pressure MPa	psi	min. burst pressure MPa	psi		
SX42LT-12	20	3/4	-12	19.1	32.4	42.0	6000	168.0	24000	260	1.72
SX42LT-16	25	1	-16	25.4	38.2	42.0	6000	168.0	24000	330	1.74
SX42LT-20	32	1 1/4	-20	31.5	46.3	42.0	6000	168.0	24000	400	2.98

The combination of high temperature and high pressure could reduce the hose life.

Hose layline example



SX42TC

No-Skive Multispiral Tough Cover

ISO 3862 Type R15 – Parker Specifications



- *No-Skive* hose construction
- High performance
- Highly abrasion resistant **TOUGH COVER**
- MSHA approved
- Reinforcement of four or six spiral high-tensile steel wire
- Constant working pressure of 42.0 MPa
- Temperature range up to +125 °C

Primary Applications

General high pressure hydraulic applications

Applicable Specifications

ISO 3862 Type R15 – Parker Specification

Construction

Inner tube: Synthetic rubber
 Reinforcement: Four or six spiral high-tensile steel wire
 Cover: Highly abrasion resistance
 MSHA approved synthetic rubber

Temperature Range -40 °C up to +125 °C

Exception: Air max. +70 °C
 Water max. +85 °C

Recommended Fluids

Hydraulic fluids on a mineral-oil basis, water-glycol and lubricating oils, air and water. For air and gas applications with a pressure exceeding 1.7 MPa, the cover must be pin-pricked. Consult the chemical compatibility section on pages **Ab-26** to **Ab-34** for more detailed information.

Fitting Series

Size -12

Size -16 and -20



Part Number	Hose I.D.				Hose O.D. mm	Pressure Rating				min. bend radius mm	weight kg
	DN	Inch	Size	mm		max. working pressure MPa	psi	min. burst pressure MPa	psi		
SX42TC-12	20	3/4	-12	19.1	32.4	42.0	6000	168.0	24000	260	1.72
SX42TC-16	25	1	-16	25.4	38.2	42.0	6000	168.0	24000	330	1.74
SX42TC-20	32	1 1/4	-20	31.5	46.3	42.0	6000	168.0	24000	400	2.98

The combination of high temperature and high pressure could reduce the hose life.

Hose layline example



701

No-Skive Multispiral

Exceeds ISO 3862 Type 4SP –
EN 856 Type 4SP

Primary Applications

General high pressure hydraulic applications

Type Approvals

Details please find on pages **Ab-16** to **Ab-19**

Applicable Specifications

Exceed ISO 3862 Type 4SP – EN 856 Type 4SP

Construction

Inner tube: Synthetic rubber
Reinforcement: Four spiral high-tensile steel wire
Cover: Synthetic rubber

Temperature Range -40 °C up to +100 °C

Exception: Air max. +70 °C
Water max. +85 °C



- **No-Skive** hose construction
- Reinforcement of four spiral high-tensile steel wire

Recommended Fluids

Hydraulic fluids on a mineral-oil basis, water-glycol and lubricating oils, air and water. For air and gas applications with a pressure exceeding 1.7 MPa, the cover must be pin-pricked. Consult the chemical compatibility section on pages **Ab-26** to **Ab-34** for more detailed information.

Fitting Series



Part Number	Hose I.D.				Hose O.D. mm	Pressure Rating				min. bend radius mm	weight kg
	DN	Inch	Size	mm		max. working pressure MPa	psi	min. burst pressure MPa	psi		
701-6	10	3/8	-6	9.5	21.4	45.0	6500	180.0	26000	180	0.78
701-8	12	1/2	-8	12.7	24.6	41.5	6000	166.0	24000	230	0.93
701-10	16	5/8	-10	15.9	28.2	35.0	5000	140.0	20000	250	1.15
701-12	19	3/4	-12	19.1	32.2	35.0	5000	140.0	20000	300	1.58
701-16	25	1	-16	25.4	39.7	28.0	4000	112.0	16000	340	2.04

The combination of high temperature and high pressure could reduce the hose life.

Hose layline example



701TC

No-Skive Multispiral Tough Cover

ISO 3862 Type 4SP – EN 856 Type 4SP

Primary Applications

General high pressure hydraulic applications

Type Approvals

Details please find on pages **Ab-16** to **Ab-19**

Applicable Specifications

ISO 3862 Type 4SP – EN 856 Type 4SP

Construction

- Inner tube: Synthetic rubber
- Reinforcement: Four spiral high-tensile steel wire
- Cover: Highly abrasion resistance
MSHA approved synthetic rubber

Temperature Range -40 °C up to +100 °C

- Exception: Air max. +70 °C
- Water max. +85 °C



- **No-Skive** hose construction
- Reinforcement of four spiral high-tensile steel wire
- Highly abrasion resistant **TOUGH COVER**
- MSHA approved
- Hose is suitable for temporary immersion in mineral oil up to 70 °C with frequent inspections

Recommended Fluids

Hydraulic fluids on a mineral-oil basis, water-glycol and lubricating oils, air and water. For air and gas applications with a pressure exceeding 1.7 MPa, the cover must be pin-pricked. Consult the chemical compatibility section on pages **Ab-26** to **Ab-34** for more detailed information.

Fitting Series



Part Number	Hose I.D.				Hose O.D. mm	Pressure Rating				min. bend radius mm	weight kg
	DN	Inch	Size	mm		max. working pressure MPa	psi	min. burst pressure MPa	psi		
701TC-6	10	3/8	-6	9.5	21.4	45.0	6500	180.0	26000	180	0.78
701TC-8	12	1/2	-8	12.7	24.6	41.5	6000	166.0	24000	230	0.93
701TC-10	16	5/8	-10	15.9	28.2	35.0	5000	140.0	20000	250	1.15
701TC-12	19	3/4	-12	19.1	32.2	35.0	5000	140.0	20000	300	1.58
701TC-16	25	1	-16	25.4	39.7	28.0	4000	112.0	16000	340	2.04

The combination of high temperature and high pressure could reduce the hose life.

Hose layline example



731

No-Skive Multispiral

Exceeds ISO 3862 Type 4SH –
EN 856 Type 4SH

Primary Applications

General high pressure hydraulic applications

Applicable Specifications

Exceed ISO 3862 Type 4SH – EN 856 Type 4SH

Construction

Inner tube: Synthetic rubber
Reinforcement: Four spiral high-tensile steel wire
Cover: Synthetic rubber

Temperature Range -40 °C up to +100 °C

Exception: Air max. +70 °C
Water max. +85 °C



- *No-Skive* hose construction
- Reinforcement of four spiral high-tensile steel wire

Recommended Fluids

Hydraulic fluids on a mineral-oil basis, water-glycol and lubricating oils, air and water. For air and gas applications with a pressure exceeding 1.7 MPa, the cover must be pin-pricked. Consult the chemical compatibility section on pages **Ab-26** to **Ab-34** for more detailed information.

Fitting Series



Part Number	Hose I.D.				Hose O.D. mm	Pressure Rating				min. bend radius mm	weight kg
	DN	Inch	Size	mm		max. working pressure MPa	psi	min. burst pressure MPa	psi		
731-12	19	3/4	-12	19.1	32.0	42.0	6000	168.0	24000	280	1.72
731-16	25	1	-16	25.4	39.0	38.0	5500	152.0	22000	340	2.14
731-20	31	1 1/4	-20	31.8	45.0	32.0	4700	130.0	18800	460	2.96
731-24	38	1 1/2	-24	38.1	53.0	29.0	4200	116.0	16800	560	3.20
731-32	51	2	-32	50.8	68.0	25.0	3600	100.0	14400	700	5.30

The combination of high temperature and high pressure could reduce the hose life.

Hose layline example



731TC

No-Skive Multispiral

ISO 3862 Type 4SH – EN 856 Type 4SH

Primary Applications

General high pressure hydraulic applications

Type Approvals

Details please find on pages **Ab-16** to **Ab-19**

Applicable Specifications

ISO 3862 Type 4SH – EN 856 Type 4SH

Construction

- Inner tube: Synthetic rubber
- Reinforcement: Four spiral high-tensile steel wire
- Cover: Highly abrasion resistance
MSHA approved synthetic rubber

Temperature Range -40 °C up to +100 °C

- Exception: Air max. +70 °C
- Water max. +85 °C



- **No-Skive** hose construction
- Reinforcement of four spiral high-tensile steel wire
- Highly abrasion resistant **TOUGH COVER**
- MSHA approved
- Hose is suitable for temporary immersion in mineral oil up to 70 °C with frequent inspections

Recommended Fluids

Hydraulic fluids on a mineral-oil basis, water-glycol and lubricating oils, air and water. For air and gas applications with a pressure exceeding 1.7 MPa, the cover must be pin-pricked. Consult the chemical compatibility section on pages **Ab-26** to **Ab-34** for more detailed information.

Fitting Series



Part Number	Hose I.D.				Hose O.D. mm	Pressure Rating				min. bend radius mm	weight kg
	DN	Inch	Size	mm		max. working pressure		min. burst pressure			
						MPa	psi	MPa	psi		
731TC-12	19	3/4	-12	19.1	32.0	42.0	6000	168.0	24000	280	1.72
731TC-16	25	1	-16	25.4	39.0	38.0	5500	152.0	22000	340	2.14
731TC-20	31	1 1/4	-20	31.8	45.0	32.0	4700	130.0	18800	460	2.96
731TC-24	38	1 1/2	-24	38.1	53.0	29.0	4200	116.0	16800	560	3.20
731TC-32	51	2	-32	50.8	68.0	25.0	3600	100.0	14400	700	5.30

Replace the hose when any deformation or damage on the hose cover are visible.
The combination of high temperature and high pressure could reduce the hose life.

Hose layline example

Parker TOUGH COVER 731TC-12 WP 42.0 MPa (6000 PSI) MSHA IC 40/26 | • • 19 mm (3/4) X 4S EN856-4SH

774

No-Skive Multispiral

For phosphate ester base fluids

Primary Applications

Test stands for aerospace, foundries, steel mills
High pressure hydraulic applications with phosphate ester fluids

Restrictions

Do not allow tube to contact any petroleum base fluids.
Use liquid soap as hose lubricant.

Applicable Specifications

Parker Specification

Construction

Inner tube: Phosphate ester resistant
EPDM synthetic rubber
Reinforcement: Four spiral high-tensile steel wire
Cover: EPDM synthetic rubber, green,
phosphate ester and weather resistant

Temperature Range -40 °C up to +80 °C



- *No-Skive* hose construction
- Phosphate ester and weather resistant, green, EPDM synthetic rubber cover

Recommended Fluids

Phosphate ester base hydraulic fluids.
Consult the chemical compatibility section on pages **Ab-26** to **Ab-34** for more detailed information.

Fitting Series

on request

Part Number	Hose I.D.				Hose O.D. mm	Pressure Rating				min. bend radius mm	weight kg
	DN	Inch	Size	mm		max. working pressure MPa	psi	min. burst pressure MPa	psi		
774-12	19	3/4	-12	19.1	31.0	28.0	4000	112.0	16000	240	1.40
774-16	25	1	-16	25.4	38.0	28.0	4000	112.0	16000	300	1.99
774-20	31	1 1/4	-20	31.8	47.0	21.0	3000	84.0	12000	420	2.59
774-24	38	1 1/2	-24	38.1	53.0	17.5	2500	70.0	10000	500	2.99
774-32	51	2	-32	50.8	67.0	17.5	2500	70.0	10000	630	4.09

The combination of high temperature and high pressure could reduce the hose life.

Hose layline example

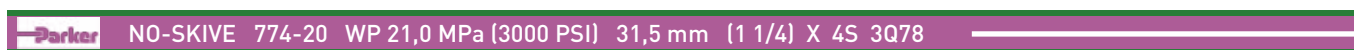

797RH

No-Skive Compact Spiral™

Fire-retardant cover

Primary Applications

General high pressure hydraulic circuits for railway applications.

Type Approvals

Details please find on pages **Ab-16** to **Ab-19**

Applicable Specifications

Exceed SAE 100R15 - ISO 3862 Type R15 - ISO 18752-DC

Construction

Inner tube: Proprietary synthetic rubber
Reinforcement: Four spiral high-tensile steel wire
Cover: Fire retardant synthetic rubber

Temperature Range -40 °C up to +125 °C

Exception: Air max. +70 °C
Water max. +85 °C



- 1/2 the bend radius of SAE 100R15
- Constant working pressure of 42.0 MPa
- Reduced O.D. and new construction lead to superior flexibility
- 1/3 less effort to bend
- Weight reduction – up to 26 %
- Railway approved:
 - European Standard EN45545 HL2 for R22 (internal) and R23 (external)

Recommended Fluids

Petroleum base hydraulic fluids and lubricating oils.
Wide Compatibility exceeding Column III, with additional chemical resistance, especially for diesel and biodiesel.
Consult the chemical compatibility section on pages **Ab-26** to **Ab-34** for more detailed information.

Fitting Series



Part Number	Hose I.D.				Hose O.D. mm	Pressure Rating				min. bend radius mm	weight kg
	DN	Inch	Size	mm		max. working pressure		min. burst pressure			
						MPa	psi	MPa	psi		
797RH-8	12	1/2	-8	12.7	21.1	42.0	6000	168.0	24000	100	0.67
797RH-10	16	5/8	-10	15.9	23.9	42.0	6000	168.0	24000	115	0.80
797RH-12	19	3/4	-12	19.1	27.9	42.0	6000	168.0	24000	135	1.16
797RH-16	25	1	-16	25.4	35.7	42.0	6000	168.0	24000	165	1.74

Replace the hose when any deformation or damage on the hose cover are visible.
The combination of high temperature and high pressure could reduce the hose life.

Hose layline example



F42

No-Skive Multispiral

For phosphate ester base fluids

Primary Applications

Test stands for aerospace, foundries, steel mills, high pressure hydraulic applications with phosphate ester fluids

Applicable Specifications

Parker Specification

Restrictions

Do not allow tube to contact any petroleum base fluids. Use liquid soap as hose lubricant.

Construction

Inner tube: Phosphate ester resistant EPDM synthetic rubber
Reinforcement: Four or six spiral high-tensile steel wire
Cover: EPDM synthetic rubber, green, phosphate ester and weather resistant

Temperature Range -40 °C up to +80 °C

Exception: Air max. +70 °C
Water max. +85 °C



- *No-Skive* hose construction
- Phosphate ester and weather resistant, green, EPDM synthetic rubber cover
- Constant working pressure of 42.0 MPa

Recommended Fluids

Phosphate ester based hydraulic fluids, water-glycol based fluids, air and water.

Consult the chemical compatibility section on pages **Ab-26** to **Ab-34** for more detailed information.

Fitting Series

Series 70 only for size -8
Size -12 up to size -20 on request



Part Number	Hose I.D.				Hose O.D. mm	Pressure Rating				min. bend radius mm	weight kg
	DN	Inch	Size	mm		max. working pressure MPa	psi	min. burst pressure MPa	psi		
F42-8	12	1/2	-8	12.7	25.0	42.0	6000	168.0	24000	200	0.83
F42-12	19	3/4	-12	19.1	31.9	42.0	6000	168.0	24000	265	1.53
F42-16	25	1	-16	25.4	38.5	42.0	6000	168.0	24000	330	2.08
F42-20	31	1 1/4	-20	31.8	50	42.0	6000	168.0	24000	445	3.96

The combination of high temperature and high pressure could reduce the hose life.

Hose layline example

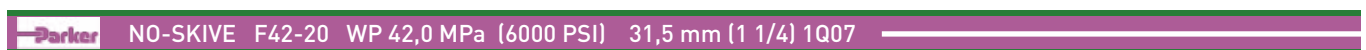

H29

ParLock Multispiral

Exceeds ISO 3862 Type 4SH –
EN 856 Type 4SH

Primary Applications

General high pressure hydraulic applications

Type Approvals

Details please find on pages **Ab-16** to **Ab-19**

Applicable Specifications

Exceed ISO 3862 Type 4SH – EN 856 Type 4SH

Construction

Inner tube: Synthetic rubber
Reinforcement: Four spiral high-tensile steel wire
Cover: Synthetic rubber

Temperature Range -40 °C up to +100 °C

Exception: Air max. +70 °C

Water max. +85 °C



- Interlock technology
- Reinforcement of four spiral high-tensile steel wire

Recommended Fluids

Hydraulic fluids on a mineral-oil basis, water-glycol and lubricating oils, air and water. For air and gas applications with a pressure exceeding 1.7 MPa, the cover must be pin-pricked. Consult the chemical compatibility section on pages **Ab-26** to **Ab-34** for more detailed information.

Fitting Series

Internal and external skiving



Part Number	Hose I.D.				Hose O.D. mm	Pressure Rating				min. bend radius mm	weight kg
	DN	Inch	Size	mm		max. working pressure MPa	psi	min. burst pressure MPa	psi		
H29-12	19	3/4	-12	19.1	32.2	43.0	6250	172.0	25000	280	1.7
H29-16	25	1	-16	25.4	38.7	40.0	5800	160.0	23200	340	2.2
H29-20	31	1 1/4	-20	31.8	45.5	35.0	5000	140.0	20000	460	2.6
H29-24	38	1 1/2	-24	38.1	53.5	31.0	4500	124.0	18000	560	3.4
H29-32	51	2	-32	50.8	68.1	28.0	4050	112.0	16200	700	4.8

The combination of high temperature and high pressure could reduce the hose life.

Hose layline example

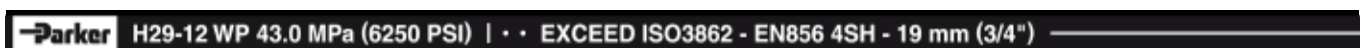

H29TC

ParLock Multispiral

Exceeds ISO 3862 Type 4SH – EN 856 Type 4SH

Primary Applications

General high pressure hydraulic applications

Type Approvals

Details please find on pages **Ab-16** to **Ab-19**

Applicable Specifications

Exceed ISO 3862 Type 4SH – EN 856 Type 4SH

Construction

- Inner tube: Synthetic rubber
- Reinforcement: Four spiral high-tensile steel wire
- Cover: Highly abrasion resistance
MSHA approved synthetic rubber

Temperature Range -40 °C up to +100 °C

- Exception: Air max. +70 °C
- Water max. +85 °C



- Interlock technology
- Reinforcement of four spiral high-tensile steel wire
- Highly abrasion resistant **TOUGH COVER**
- MSHA approved
- Hose is suitable for temporary immersion in mineral oil up to 70 °C with frequent inspections

Recommended Fluids

Hydraulic fluids on a mineral-oil basis, water-glycol and lubricating oils, air and water. For air and gas applications with a pressure exceeding 1.7 MPa, the cover must be pin-pricked. Consult the chemical compatibility section on pages **Ab-26** to **Ab-34** for more detailed information.

Fitting Series

Internal and external skiving



Part Number	Hose I.D.				Hose O.D. mm	Pressure Rating				min. bend radius mm	weight kg
	DN	Inch	Size	mm		max. working pressure MPa	psi	min. burst pressure MPa	psi		
H29TC-12	19	3/4	-12	19.1	32.2	43.0	6250	172.0	25000	280	1.7
H29TC-16	25	1	-16	25.4	38.7	40.0	5800	160.0	23200	340	2.2
H29TC-20	31	1 1/4	-20	31.8	45.5	35.0	5000	140.0	20000	460	2.6
H29TC-24	38	1 1/2	-24	38.1	53.5	31.0	4500	124.0	18000	560	3.4
H29TC-32	51	2	-32	50.8	68.1	28.0	4050	112.0	16200	700	4.8

The combination of high temperature and high pressure could reduce the hose life.

Hose layline example

Parker TOUGH COVER H29TC-12 WP 43,0 MPa (6250 PSI) MSHA IC 40/26 | • EXCEED ISO3862 - EN856



H29ST

ParLock Multispiral

Exceeds ISO 3862 Type 4SH – EN 856 Type 4SH

Primary Applications

General high pressure hydraulic applications

Type Approvals

Details please find on pages **Ab-16** to **Ab-19**

Applicable Specifications

Exceed ISO 3862 Type 4SH – EN 856 Type 4SH

Construction

Inner tube: Synthetic rubber
Reinforcement: Four spiral high-tensile steel wire
Cover: Synthetic rubber with a special polyethylene coating

Temperature Range -40 °C up to +100 °C

Exception: Air max. +70 °C

Water max. +85 °C



- Interlock technology
- Extreme abrasion resistant **SUPER TOUGH** cover
- Reinforcement of four spiral high-tensile steel wire

Recommended Fluids

Hydraulic fluids on a mineral-oil basis, water-glycol and lubricating oils, air and water. For air and gas applications with a pressure exceeding 1.7 MPa, the cover must be pin-pricked. Consult the chemical compatibility section on pages **Ab-26** to **Ab-34** for more detailed information.

Fitting Series

Internal and external skiving



Part Number	Hose I.D.				Hose O.D. mm	Pressure Rating				min. bend radius mm	weight kg
	DN	Inch	Size	mm		max. working pressure		min. burst pressure			
						MPa	psi	MPa	psi		
H29ST-12	19	3/4	-12	19.1	32.2	43.0	6250	172.0	25000	280	1.7
H29ST-16	25	1	-16	25.4	38.7	40.0	5800	160.0	23200	340	2.2
H29ST-20	31	1 1/4	-20	31.8	45.5	35.0	5000	140.0	20000	460	2.6
H29ST-24	38	1 1/2	-24	38.1	53.5	31.0	4500	124.0	18000	560	3.4
H29ST-32	51	2	-32	50.8	68.1	28.0	4050	112.0	16200	700	4.8

Replace the hose when any deformation or damage on the hose cover are visible.
The combination of high temperature and high pressure could reduce the hose life.

Hose layline example

Parker SUPER TOUGH H29ST-12 WP 43,0 MPa (6250 PSI) | · · EXCEED ISO3862 - EN856 4SH

H31

ParLock Multispiral

Exceeds ISO 3862 Type 4SP –
EN 856 Type 4SP

Primary Applications

General high pressure hydraulic applications

Type Approvals

Details please find on pages **Ab-16** to **Ab-19**

Applicable Specifications

Exceed ISO 3862 Type 4SP – EN 856 Type 4SP

Construction

Inner tube: Synthetic rubber
Reinforcement: Four spiral high-tensile steel wire
Cover: Synthetic rubber

Temperature Range -40 °C up to +100 °C

Exception: Air max. +70 °C
Water max. +85 °C



- Interlock technology
- Reinforcement of four spiral high-tensile steel wire

Recommended Fluids

Hydraulic fluids on a mineral-oil basis, water-glycol and lubricating oils, air and water. For air and gas applications with a pressure exceeding 1.7 MPa, the cover must be pin-pricked. Consult the chemical compatibility section on pages **Ab-26** to **Ab-34** for more detailed information.

Fitting Series

External skiving (size -4 up to -8)

Internal and external skiving (size -10 up to -16)



Part Number	Hose I.D.				Hose O.D. mm	Pressure Rating				min. bend radius mm	weight kg
	DN	Inch	Size	mm		max. working pressure MPa	psi	min. burst pressure MPa	psi		
H31-4	6	1/4	-4	6.4	17.8	50.0	7250	200.0	29000	120	0.73
H31-6	10	3/8	-6	9.5	21.4	44.5	6450	178.0	25800	130	0.91
H31-8	12	1/2	-8	12.7	24.6	41.5	6000	166.0	24000	180	1.08
H31-10	16	5/8	-10	15.9	28.5	39.0	5650	156.0	22600	225	1.39
H31-12	19	3/4	-12	19.1	32.0	35.0	5000	140.0	20300	280	1.73
H31-16	25	1	-16	25.4	39.7	31.0	4500	124.0	18000	355	2.31

The combination of high temperature and high pressure could reduce the hose life.

Hose layline example



H31TC

ParLock Multispiral

Exceeds ISO 3862 Type 4SP – EN 856 Type 4SP

Primary Applications

General high pressure hydraulic applications

Type Approvals

Details please find on pages **Ab-16** to **Ab-19**

Applicable Specifications

Exceed ISO 3862 Type 4SP – EN 856 Type 4SP

Construction

- Inner tube: Synthetic rubber
- Reinforcement: Four spiral high-tensile steel wire
- Cover: Highly abrasion resistance
MSHA approved synthetic rubber

Temperature Range -40 °C up to +100 °C

- Exception: Air max. +70 °C
- Water max. +85 °C



- Interlock technology
- Reinforcement of four spiral high-tensile steel wire
- Highly abrasion resistant **TOUGH COVER**
- MSHA approved
- Hose is suitable for temporary immersion in mineral oil up to 70 °C with frequent inspections

Recommended Fluids

Hydraulic fluids on a mineral-oil basis, water-glycol and lubricating oils, air and water. For air and gas applications with a pressure exceeding 1.7 MPa, the cover must be pin-pricked. Consult the chemical compatibility section on pages **Ab-26** to **Ab-34** for more detailed information.

Fitting Series

External skiving (size -4 up to -8)

Internal and external skiving (size -10 up to -16)



Part Number	Hose I.D.				Hose O.D. mm	Pressure Rating				min. bend radius mm	weight kg
	DN	Inch	Size	mm		max. working pressure		min. burst pressure			
						MPa	psi	MPa	psi		
H31TC-4	6	1/4	-4	6.4	17.8	50.0	7250	200.0	29000	120	0.73
H31TC-6	10	3/8	-6	9.5	21.4	44.5	6450	178.0	25800	130	0.91
H31TC-8	12	1/2	-8	12.7	24.6	41.5	6000	166.0	24000	180	1.08
H31TC-10	16	5/8	-10	15.9	28.5	39.0	5650	156.0	22600	225	1.39
H31TC-12	19	3/4	-12	19.1	32.0	35.0	5000	140.0	20300	280	1.73
H31TC-16	25	1	-16	25.4	39.7	31.0	4500	124.0	18000	355	2.31

Replace the hose when any deformation or damage on the hose cover are visible. The combination of high temperature and high pressure could reduce the hose life.

Hose layline example

Parker TOUGH COVER H31TC-6 WP 44,5 MPa (6450 PSI) MSHA IC 40/26 | · · EXCEED ISO3862 - EN856 45

H31ST

ParLock Multispiral

Exceeds ISO 3862 Type 4SP – EN 856 Type 4SP

Primary Applications

General high pressure hydraulic applications

Type Approvals

Details please find on pages **Ab-16** to **Ab-19**

Applicable Specifications

Exceed ISO 3862 Type 4SP – EN 856 Type 4SP

Construction

- Inner tube: Synthetic rubber
- Reinforcement: Four spiral high-tensile steel wire
- Cover: Synthetic rubber with a special polyethylene coating

Temperature Range -40 °C up to +100 °C

- Exception: Air max. +70 °C
- Water max. +85 °C



- Interlock technology
- Extreme abrasion resistant **SUPER TOUGH** cover
- Reinforcement of four spiral high-tensile steel wire

Recommended Fluids

Hydraulic fluids on a mineral-oil basis, water-glycol and lubricating oils, air and water. For air and gas applications with a pressure exceeding 1.7 MPa, the cover must be pin-pricked. Consult the chemical compatibility section on pages **Ab-26** to **Ab-34** for more detailed information.

Fitting Series

External skiving (size -4 up to -8)

Internal and external skiving (size -10 up to -16)



Part Number	Hose I.D.				Hose O.D. mm	Pressure Rating				min. bend radius mm	weight kg
	DN	Inch	Size	mm		max. working pressure MPa	psi	min. burst pressure MPa	psi		
H31ST-4	6	1/4	-4	6.4	17.8	50.0	7250	200.0	29000	120	0.73
H31ST-6	10	3/8	-6	9.5	21.4	44.5	6450	178.0	25800	130	0.91
H31ST-8	12	1/2	-8	12.7	24.6	41.5	6000	166.0	24000	180	1.08
H31ST-10	16	5/8	-10	15.9	28.5	39.0	5650	156.0	22600	225	1.39
H31ST-12	19	3/4	-12	19.1	32.0	35.0	5000	140.0	20300	280	1.73
H31ST-16	25	1	-16	25.4	39.7	31.0	4500	124.0	18000	355	2.31

The combination of high temperature and high pressure could reduce the hose life.

Hose layline example

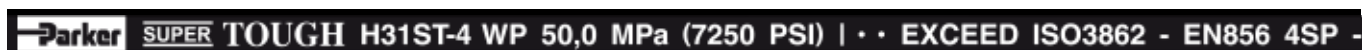

R35

ParLock Multispiral

Exceeds ISO 3862 Type R13 – Parker Specifications

Primary Applications

General high pressure hydraulic applications

Type Approvals

Details please find on pages **Ab-16** to **Ab-19**

Applicable Specifications

Exceed ISO 3862 Type R13 – Parker Specification

Construction

- Inner tube: Synthetic rubber
- Reinforcement: Four or six spiral high-tensile steel wire
- Cover: Synthetic rubber

Temperature Range -40 °C up to +125 °C

- Exception: Air max. +70 °C
- Water max. +85 °C



- Interlock technology
- Reinforcement of four or six spiral high-tensile steel wire
- Constant working pressure of 35.0 MPa

Recommended Fluids

Hydraulic fluids on a mineral-oil basis, water-glycol and lubricating oils, air and water. For air and gas applications with a pressure exceeding 1.7 MPa, the cover must be pin-pricked. Consult the chemical compatibility section on pages **Ab-26** to **Ab-34** for more detailed information.

Fitting Series

Internal and external skiving (size -12, -16, -20)



Internal and external skiving (size -24, -32)



Part Number	Hose I.D.				Hose O.D. mm	Pressure Rating				min. bend radius mm	weight kg
	DN	Inch	Size	mm		max. working pressure		min. burst pressure			
						MPa	psi	MPa	psi		
R35-12	19	3/4	-12	19.1	32.00	35.0	5000	140.0	20000	220	1.5
R35-16	25	1	-16	25.4	39.35	35.0	5000	140.0	20000	280	2.2
R35-20	31	1 1/4	-20	31.8	45.50	35.0	5000	140.0	20000	380	2.6
R35-24	38	1 1/2	-24	38.1	57.30	35.0	5000	140.0	20000	480	4.8
R35-32	51	2	-32	50.8	71.10	35.0	5000	140.0	20000	600	6.7

The combination of high temperature and high pressure could reduce the hose life.

Hose layline example



R35TC/RS35TC-48

ParLock Multispiral

Exceeds ISO 3862 Type R13 – Parker Specifications

Primary Applications

General high pressure hydraulic applications

Type Approvals

Details please find on pages **Ab-16** to **Ab-19**

Applicable Specifications

Exceed ISO 3862 Type R13 – Parker Specification

Construction

- Inner tube: Synthetic rubber
- Reinforcement: Four or six spiral high-tensile steel wire
- Cover: Highly abrasion resistance
MSHA approved synthetic rubber

Temperature Range -40 °C up to +125 °C

- Exception: Air max. +70 °C
- Water max. +85 °C

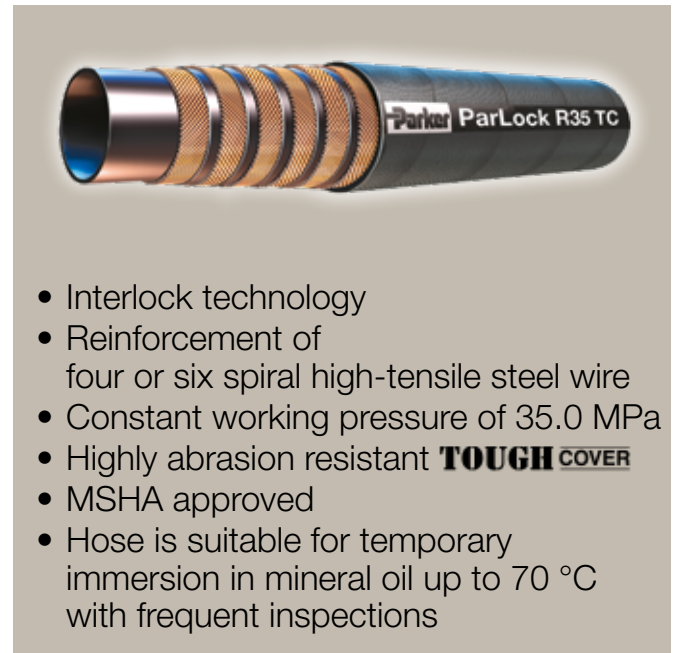

- Interlock technology
- Reinforcement of four or six spiral high-tensile steel wire
- Constant working pressure of 35.0 MPa
- Highly abrasion resistant **TOUGH COVER**
- MSHA approved
- Hose is suitable for temporary immersion in mineral oil up to 70 °C with frequent inspections

Recommended Fluids

Hydraulic fluids on a mineral-oil basis, water-glycol and lubricating oils, air and water. For air and gas applications with a pressure exceeding 1.7 MPa, the cover must be pin-pricked. Consult the chemical compatibility section on pages **Ab-26** to **Ab-34** for more detailed information.

Fitting Series

- Internal and external skiving (size -12 up to -20) **V4**
- Internal and external skiving (size -24 up to -48) **V6**

Part Number	Hose I.D.				Hose O.D. mm	Pressure Rating				min. bend radius mm	weight kg
	DN	Inch	Size	mm		max. working pressure MPa	psi	min. burst pressure MPa	psi		
R35TC-12	19	3/4	-12	19.1	32.00	35.0	5000	140.0	20000	220	1.5
R35TC-16	25	1	-16	25.4	39.35	35.0	5000	140.0	20000	280	2.2
R35TC-20	31	1 1/4	-20	31.8	45.50	35.0	5000	140.0	20000	380	2.6
R35TC-24	38	1 1/2	-24	38.1	57.30	35.0	5000	140.0	20000	480	4.8
R35TC-32	51	2	-32	50.8	71.10	35.0	5000	140.0	20000	600	6.7
R35TC-40	63	2 1/2	-40	63.5	84.50	35.0	5000	140.0	20000	800	9.0
RS35TC-48	76	3	-48	76.2	96.00	35.0*	5000*	88.0	12750	900	10.0
RS35TC-48	76	3	-48	76.2	96.00	21.0**	3040**	88.0	12750	900	10.0

Replace the hose when any deformation or damage on the hose cover are visible. The combination of high temperature and high pressure could reduce the hose life.

* 35 MPa: Static applications according to ISO 6807-D

** 21 MPa: Dynamic hydraulic application design factor > 4:1

Hose layline example



R42

ParLock Multispiral

Exceeds ISO 3862 Type R15 – Parker Specifications

Primary Applications

General high pressure hydraulic applications

Type Approvals

Details please find on pages **Ab-16** to **Ab-19**

Applicable Specifications

Exceed ISO 3862 Type R15 – Parker Specification

Construction

- Inner tube: Synthetic rubber
- Reinforcement: Four or six spiral high-tensile steel wire
- Cover: Synthetic rubber

Temperature Range -40 °C up to +125 °C

Exception: Air max. +70 °C

Water max. +85 °C



- Interlock technology
- Reinforcement of four or six spiral high-tensile steel wire
- Constant working pressure of 42.0 MPa

Recommended Fluids

Hydraulic fluids on a mineral-oil basis, water-glycol and lubricating oils, air and water. For air and gas applications with a pressure exceeding 1.7 MPa, the cover must be pin-pricked. Consult the chemical compatibility section on pages **Ab-26** to **Ab-34** for more detailed information.

Fitting Series

Internal and external skiving (size -10, -12, -16)



Internal and external skiving (size -20, -24, -32)



Part Number	Hose I.D.				Hose O.D. mm	Pressure Rating				min. bend radius mm	weight kg
	DN	Inch	Size	mm		max. working pressure MPa	psi	min. burst pressure MPa	psi		
R42-10	16	5/8	-10	15.9	28.50	42.0	6000	168.0	24000	225	1.39
R42-12	19	3/4	-12	19.1	32.00	42.0	6000	168.0	24000	280	1.70
R42-16	25	1	-16	25.4	39.00	42.0	6000	168.0	24000	300	2.30
R42-20	31	1 1/4	-20	31.8	50.75	42.0	6000	168.0	24000	400	3.80
R42-24	38	1 1/2	-24	38.1	57.00	42.0	6000	168.0	24000	500	4.80
R42-32	51	2	-32	50.8	71.50	42.0	6000	168.0	24000	700	7.00

The combination of high temperature and high pressure could reduce the hose life.

Hose layline example



R42TC

ParLock Multispiral

Exceeds ISO 3862 Type R15 – Parker Specifications

Primary Applications

General high pressure hydraulic applications

Type Approvals

Details please find on pages **Ab-16** to **Ab-19**

Applicable Specifications

Exceed ISO 3862 Type R15 – Parker Specification

Construction

- Inner tube: Synthetic rubber
- Reinforcement: Four or six spiral high-tensile steel wire
- Cover: Highly abrasion resistance
MSHA approved synthetic rubber

Temperature Range -40 °C up to +125 °C

- Exception: Air max. +70 °C
- Water max. +85 °C



- Interlock technology
- Reinforcement of four or six spiral high-tensile steel wire
- Constant working pressure of 42.0 MPa
- Highly abrasion resistant **TOUGH COVER**
- MSHA approved
- Hose is suitable for temporary immersion in mineral oil up to 70 °C with frequent inspections

Recommended Fluids

Hydraulic fluids on a mineral-oil basis, water-glycol and lubricating oils, air and water. For air and gas applications with a pressure exceeding 1.7 MPa, the cover must be pin-pricked. Consult the chemical compatibility section on pages **Ab-26** to **Ab-34** for more detailed information.

Fitting Series

Internal and external skiving (size -10, -12, -16)



Internal and external skiving (size -20, -24, -32)



Part Number	Hose I.D.				Hose O.D. mm	Pressure Rating				min. bend radius mm	weight kg
	DN	Inch	Size	mm		max. working pressure MPa	psi	min. burst pressure MPa	psi		
R42TC-10	16	5/8	-10	15.9	28.50	42.0	6000	168.0	24000	225	1.39
R42TC-12	19	3/4	-12	19.1	32.00	42.0	6000	168.0	24000	280	1.70
R42TC-16	25	1	-16	25.4	39.00	42.0	6000	168.0	24000	300	2.30
R42TC-20	31	1 1/4	-20	31.8	50.75	42.0	6000	168.0	24000	400	3.80
R42TC-24	38	1 1/2	-24	38.1	57.00	42.0	6000	168.0	24000	500	4.80
R42TC-32	51	2	-32	50.8	71.50	42.0	6000	168.0	24000	700	7.00

Replace the hose when any deformation or damage on the hose cover are visible. The combination of high temperature and high pressure could reduce the hose life.

Hose layline example

Parker TOUGH COVER R42TC-32 WP 42.0 MPa (6000 PSI) MSHA IC 40/26 | · · ISO 3862 - SAE100R

R42ST

ParLock Multispiral

Exceeds ISO 3862 Type R15 – Parker Specifications

Primary Applications

General high pressure hydraulic applications

Type Approvals

Details please find on pages **Ab-16** to **Ab-19**

Applicable Specifications

Exceed ISO 3862 Type R15 – Parker Specification

Construction

Inner tube: Synthetic rubber
Reinforcement: Four or six spiral high-tensile steel wire
Cover: Synthetic rubber with a special polyethylene coating

Temperature Range -40 °C up to +125 °C

Exception: Air max. +70 °C

Water max. +85 °C





- Interlock technology
- Extreme abrasion resistant **SUPER TOUGH** cover
- Reinforcement of four or six spiral high-tensile steel wire
- Constant working pressure of 42.0 MPa

Recommended Fluids

Hydraulic fluids on a mineral-oil basis, water-glycol and lubricating oils, air and water. For air and gas applications with a pressure exceeding 1.7 MPa, the cover must be pin-pricked. Consult the chemical compatibility section on pages **Ab-26** to **Ab-34** for more detailed information.

Fitting Series

Internal and external skiving (size -10, -12, -16) 

Internal and external skiving (size -20, -24, -32) 

Part Number	Hose I.D.				Hose O.D. mm	Pressure Rating				min. bend radius mm	weight kg
	DN	Inch	Size	mm		max. working pressure MPa	psi	min. burst pressure MPa	psi		
R42ST-10	16	5/8	-10	15.9	28.50	42.0	6000	168.0	24000	225	1.39
R42ST-12	19	3/4	-12	19.1	32.00	42.0	6000	168.0	24000	280	1.70
R42ST-16	25	1	-16	25.4	39.00	42.0	6000	168.0	24000	300	2.30
R42ST-20	31	1 1/4	-20	31.8	50.75	42.0	6000	168.0	24000	400	3.80
R42ST-24	38	1 1/2	-24	38.1	57.00	42.0	6000	168.0	24000	500	4.80
R42ST-32	51	2	-32	50.8	71.50	42.0	6000	168.0	24000	700	7.00

The combination of high temperature and high pressure could reduce the hose life.

Hose layline example



R50TC/R56TC

ParLock Multispiral

Exceeds ISO 3862 Type R15 – Parker Specifications

Primary Applications

Mobile hydraulic equipment and agricultural machines with typically large constructions.

Type Approvals

Details please find on pages **Ab-16** to **Ab-19**

Applicable Specifications

Exceed ISO 3862 Type R15 – Parker Specification

Construction

- Inner tube: Synthetic rubber
- Reinforcement: Four or six spiral high-tensile steel wire
- Cover: Highly abrasion resistance
MSHA approved synthetic rubber

Temperature Range -40 °C up to +100 °C

- Exception: Air max. +70 °C
- Water max. +85 °C



- Interlock technology
- Reinforcement of four or six spiral high-tensile steel wire
- Constant working pressure of 50.0 MPa (R50TC) and 56.0 MPa (R56TC)
- Highly abrasion resistant **TOUGH COVER**
- MSHA approved
- Hose is suitable for temporary immersion in mineral oil up to 70 °C with frequent inspections

Recommended Fluids

Hydraulic fluids on a mineral-oil basis, water-glycol and lubricating oils, air and water. For air and gas applications with a pressure exceeding 1.7 MPa, the cover must be pin-pricked. Consult the chemical compatibility section on pages **Ab-26** to **Ab-34** for more detailed information.

Fitting Series Internal and external skiving

- R56TC-4 up to R56TC-8
- R50TC-10 up to -16
- R50TC-20



Part Number	Hose I.D.				Hose O.D. mm	Pressure Rating				min. bend radius mm	weight kg
	DN	Inch	Size	mm		max. working pressure MPa	psi	min. burst pressure MPa	psi		
R56TC-4	6	1/4	-4	6.4	17.9	56.0	8100	224.0	32400	120	0.65
R56TC-6	10	3/8	-6	9.5	21.8	56.0	8100	224.0	32400	130	0.95
R56TC-8	12	1/2	-8	12.7	25.5	56.0	8100	224.0	32400	180	1.25
R50TC-10	16	5/8	-10	15.9	28.50	50.0	7250	200.0	29000	225	1.48
R50TC-12	19	3/4	-12	19.1	32.00	50.0	7250	200.0	29000	270	1.85
R50TC-16	25	1	-16	25.4	38.40	50.0	7250	200.0	29000	300	2.70
R50TC-20	31	1 1/4	-20	31.8	52.60	50.0	7250	200.0	29000	450	5.00

Replace the hose when any deformation or damage on the hose cover are visible. The combination of high temperature and high pressure could reduce the hose life.

Hose layline example

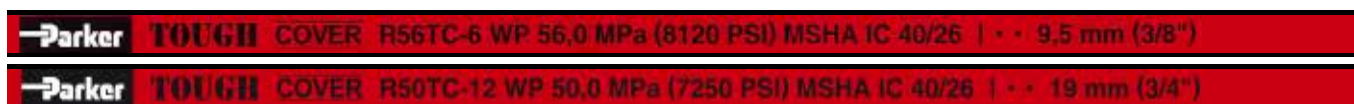

BPK

Blastopak ParLock Multispiral

DIN EN 1829-2



Primary Applications

Water blasting applications, water cutting applications, cleaning and paint or corrosion removal.

Not recommended for dynamic hydraulic applications

Applicable Specifications

Exceed ISO 3862 Type R15 – Parker Specification

Construction

Inner tube: Synthetic rubber

Reinforcement: Four or six spiral high-tensile steel wire

Cover: Synthetic rubber

Continuous Service Temperature Range

-10 °C up to +70 °C

Max. Service Temperature Range

-40 °C up to +93 °C



- Interlock technology
- Reinforcement of four or six spiral high-tensile steel wire
- DIN EN 1829-2
- Each hose assembly have to be proof tested at 1.5 WP with test report

Applicable Specifications

DIN EN 1829-2

Recommended Fluids

Water, water-soap emulsion

Fitting Series

Internal and external skiving



Part Number	Hose I.D.				Hose O.D. mm	Pressure Rating				min. bend radius mm	weight kg
	DN	Inch	Size	mm		max. working pressure		min. burst pressure			
						MPa	psi	MPa	psi		
BPK-6	10	3/8	-6	9.5	21.8	110.0	15900	275.0	39800	130	1.10
BPK-8	12	1/2	-8	12.7	25.5	110.0	15900	275.0	39800	200	1.40
BPK-12	20	3/4	-12	19.1	35.2	110.0	15900	275.0	39800	250	2.50
BPK-16	25	1	-16	25.4	41.8	80.0	11600	200.0	29000	300	3.00

Replace the hose when any deformation or damage on the hose cover are visible.
The combination of high temperature and high pressure could reduce the hose life.

Hose layline example



FA35

ParLock Multispiral Firearmor Blowout Preventer Application

Meets API 16D – Lloyd’s 1000/499 fire test

Primary Applications

Hydraulic system that operates the BOP security valve, both armored and without external protection. To be used on all rigs where fire resistance acc. to API 16D specifications are required.

Applicable Specifications

Meets API 16D – Lloyd’s 1000/499 fire test

Construction

- Inner tube: Synthetic rubber
- Reinforcement: Four or six spiral high-tensile steel wire
- Cover: Special red flame resistant compound

Temperature Range -40 °C up to +100 °C

- Exception: Air max. +70 °C
- Water max. +85 °C



- Interlock Technology
- Fire armored as blowout preventer
- Special red flame resistant cover compound
- Constant working pressure of 35.0 MPa
- Design factor 4:1
- Very flexible
- Size -6 and -8 only to use with special sleeve FS-R-6 and FS-R-8
- Can be assembled only by Parker BOP certified distributors

Recommended Fluids

Hydraulic fluids on a mineral-oil basis, water-glycol and lubricating oils, air and water. For air and gas applications with a pressure exceeding 1.7 MPa, the cover must be pin-pricked. Consult the chemical compatibility section on pages **Ab-26** to **Ab-34** for more detailed information.

Fitting Series

External skiving (size -6 and -8)

Internal and external skiving (size -10 up to -20)

Internal and external skiving (size -24 and -32)



Part Number	Hose I.D.				Hose O.D. mm	Pressure Rating				min. bend radius mm	weight kg
	DN	Inch	Size	mm		max. working pressure MPa	psi	min. burst pressure MPa	psi		
FA35-6	10	3/8	-6	9.5	22.8	35.0	5000	140.0	20000	130	0.91
FA35-8	12	1/2	-8	12.7	25.2	35.0	5000	140.0	20000	180	1.08
FA35-10	16	5/8	-10	15.9	29.5	35.0	5000	140.0	20000	225	1.39
FA35-12	19	3/4	-12	19.1	32.4	35.0	5000	140.0	20000	280	1.70
FA35-16	25	1	-16	25.4	39.0	35.0	5000	140.0	20000	340	2.20
FA35-20	31	1 1/4	-20	31.8	46.6	35.0	5000	140.0	20000	460	2.60
FA35-24	38	1 1/2	-24	38.1	58.7	35.0	5000	140.0	20000	480	4.80
FA35-32	51	2	-32	50.8	72.0	35.0	5000	140.0	20000	600	6.70

Replace the hose when any deformation or damage on the hose cover are visible. The combination of high temperature and high pressure could reduce the hose life.

Parker BOP FS-R

is a red PKR rubber flame resistant sleeve that must be used for BOP hose assembly in order to protect the fitting area and be approved in accordance with the API 16D flame test. The sleeve has to be fit over the fitting and doesn't need any clamp to be fixed.



Part Numbers: FS-R-6, FS-R-8

Hose layline example



RD35TC

ParLock Multispiral Drilling Application

API 7K Grade D/ISO 14693

Primary Applications

Rotary drilling and vibrator high pressure hydraulic applications

Type Approvals

Details please find on pages **Ab-16** to **Ab-19**

Applicable Specifications

API 7K Grade D/ISO 14693

Construction

Inner tube: Synthetic rubber
Reinforcement: Six spiral high-tensile steel wire
Cover: Highly abrasion resistance
MSHA approved synthetic rubber

Temperature Range -20 °C up to +100 °C

Exception: Air max. +70 °C
Water max. +85 °C



- Interlock Technology
- Reinforcement of six spiral high-tensile steel wire
- Constant working pressure of 35.0 MPa
- Design factor 2.5:1
- Highly abrasion resistant **TOUGH COVER**
- MSHA approved
- Hose is suitable for temporary immersion in mineral oil up to 70 °C with frequent inspections
- Antistatic properties

Recommended Fluids

Water, mud and cement, mineral oils, glycols and polyglycols, mineral oils in aqueous emulsion. Consult the chemical compatibility section on pages **Ab-26** to **Ab-34** for more detailed information.

Fitting Series

Internal and external skiving



Part Number	Hose I.D.				Hose O.D. mm	Pressure Rating				min. bend radius mm	weight kg
	DN	Inch	Size	mm		max. working pressure		min. burst pressure			
						MPa	psi	MPa	psi		
RD35TC-32	51	2	-32	50.8	71.10	35.0	5000	88.0*	12750	600	6.7
RD35TC-40	63	2 1/2	-40	63.5	84.50	35.0	5000	88.0*	12750	800	9.0
RD35TC-48	76	3	-48	76.2	96.00	35.0	5000	88.0*	12750	900	10.0

Replace the hose when any deformation or damage on the hose cover are visible. The combination of high temperature and high pressure could reduce the hose life.

Hose layline example

Parker ROTARY DRILLING VIBRATOR **RD35TC-48** WP 34,5 MPa (5000 PSI) TEST PRESS. 69,0 MPa (10000 PSI) ISO 14693 GRADE D MSHA IC 40/26 -20°C TO +100°C -4°F TO +212°F DN 76 mm (3") 1st MADE IN ITALY

CEM69TC

ParLock Multispiral Cementing Hose

According to API 7K

Primary Applications

Dedicated for cementing hose applications with flexible connection between the cementing pump manifold and cementing head for conveyance of cement slurries at high pressure.

Type Approvals

DNV-GL type examination certificate in accordance with API 7K.

Applicable Specifications

API 7K FSL0, ISO 14693

Construction

Inner Tube: Synthetic rubber
Reinforcement: Six spirals high-tensile steel wire
Cover: Highly abrasion resistance
MSHA approved synthetic rubber

Temperature Range -20 °C up to +100 °C

Exception: Air max. +70 °C
Water max. +85 °C



- Interlock technology
- Reinforcement of six high tensile steel wire
- Design factor 1:2,25
- Highly abrasion resistant **TOUGH COVER**
- MSHA approved
- Antistatic properties

Recommended Fluids

Water and mud, mineral oils, glycols, polyglycol, mineral oils in aqueous emulsion and liquid cement.

Fitting Series

Internal and external skiving



Part Number	Hose I.D.				Hose O.D. mm	max. working pressure MPa psi	Pressure Rating		min. burst pressure MPa psi	min. bend radius mm	weight kg
	DN	Inch	Size	mm			test pressure MPa psi	MPa psi			
CEM69TC-32	51	2	-32	50.8	71.5	69.0 10000	103.4 15000	155.3 22500	1000	7.00	

Replace the hose when any deformation or damage on the hose cover are visible. The combination of high temperature and high pressure could reduce the hose life.







Hose layline example

	CEMENTING HOSE NOT FOR SOUR SERVICE	CEM69TC-32	WP 69,0 MPA (10000 PSI) TEST PRESS. 103,4 MPA (15000 PSI)	API 7K - FSL 0 MSHA IC 40/26	-20°C TO +100 °C -4 °F TO +212 °F	DN 51 mm (2") 1" MADE IN ITALY
--	--	-------------------	--	---------------------------------	--------------------------------------	-----------------------------------

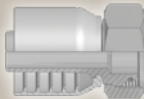

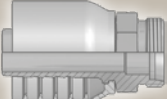

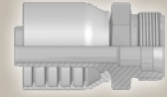

DIN – Metric

Page Db-1 – Db-4

<p>CA Db-1 Female Metric 24° Light Series with O-Ring Swivel – Straight ISO 12151-2-SWS-L – DKOL</p> 	<p>CE Db-1 Female Metric 24° Light Series with O-Ring Swivel – 45° Elbow ISO 12151-2-SWE-L – DKOL 45°</p> 	<p>CF Db-2 Female Metric 24° Light Series with O-Ring Swivel – 90° Elbow ISO 12151-2-SWE-L – DKOL 90°</p> 	<p>D0 Db-2 Male Metric 24° Light Series – Rigid Straight ISO 12151-2-S-L – CEL</p> 
<p>C9 Db-3 Female Metric 24° – Swivel Heavy Series with O-Ring Straight ISO 12151-2-SWS-S – DKOS</p> 	<p>0C Db-3 Female Metric 24° – Swivel Heavy Series with O-Ring 45° Elbow ISO 12151-2 – SWE-S – DKOS 45°</p> 	<p>1C Db-4 Female Metric 24° – Swivel Heavy Series with O-Ring 90° Elbow ISO 12151-2-SWE-S – DKOS 90°</p> 	<p>D2 Db-4 Male Metric 24° – Rigid Heavy Series – Straight ISO 12151-2-S-S – CES</p> 

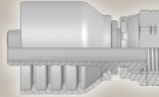
BSP

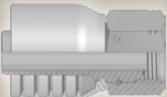
Page Db-5 – Db-7

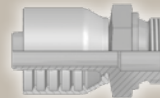
<p>92 Db-5 Female BSP Parallel Pipe Swivel – Straight (60° Cone) BS5200-A – DKR</p> 	<p>B1 Db-5 Female BSP Parallel Pipe Swivel 45° Elbow (60° Cone) BS 5200-D – DKR 45°</p> 	<p>B2 Db-6 Female BSP Parallel Pipe Swivel 90° Elbow (60° Cone) BS 5200-B – DKR 90°</p> 	<p>EA Db-6 BSP Swivel Female with O-Ring (60° Cone) BS 5200 – ISO 12151-6 – DKOR</p> 
<p>EC Db-7 BSP Swivel Female with O-Ring 90° Elbow (60° Cone) BS 5200 – ISO 12151-6 – DKOR 90°</p> 	<p>D9 Db-7 Male BSP Parallel Pipe Rigid – Straight (60° Cone) BS5200 – AGR</p> 		

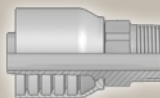
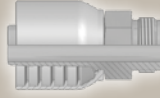
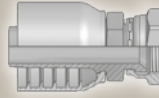
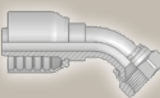
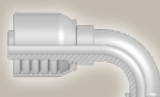

SAE

Page Db-8 – Db-10

<p>01 Db-8 Male NPTF Pipe Rigid – Straight SAE J476A / J516 – AGN</p> 	<p>03 Db-8 Male JIC 37° – Rigid Straight ISO12151-5-S – AGJ</p> 	<p>06 Db-9 Female JIC 37° – Swivel Straight ISO12151-5-SWS – DKJ</p> 	<p>37 Db-10 Female JIC 37° – Swivel 45° Elbow ISO 12151-5-SWE 45° – DKJ 45°</p> 
<p>39/3W Db-10 Female JIC 37° SAE 45° – Dual Flare Swivel Female 90° Elbow ISO 12151-5-SWES – DKJ 90°</p> 			

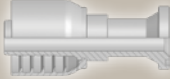
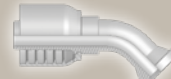
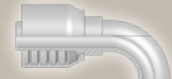
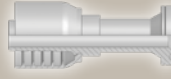
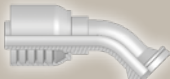
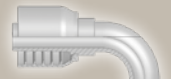

Flange

Page Db-11 – Db-14

<p>15 Db-11 ISO 6162-1-Flange Straight ISO 12151-3-S-L – SFL (21.0 MPa/ 3000 psi)</p> 	<p>17 Db-11 ISO 6162-1 Flange 45° Elbow ISO 12151-3 – E45 – L – SFL 45° (21.0 MPa/ 3000 psi)</p> 	<p>19 Db-12 ISO 6162-1-Flange 90° Elbow ISO 12151-3 – E – L – SFL 90° (21.0 MPa/ 3000 psi)</p> 	<p>6A Db-12 ISO 6162-2-Flange Straight ISO 12151-3-S-S – SFS (42.0 MPa/ 6000 psi)</p> 
<p>6F Db-13 ISO 6162-2-Flange 45° Elbow – Heavy Series ISO 12151-3 – E45-S – SFS 45° (42.0 MPa/ 6000 psi)</p> 	<p>6N Db-13 ISO 6162-2-Flange 90° Elbow ISO 12151-3 – E-S – SFS 90° (42.0 MPa/ 6000 psi)</p> 	<p>PY Db-14 Flange – 24° Male French Gas Straight</p> 	

ORFS

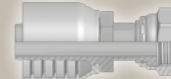
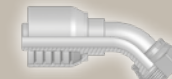
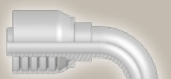
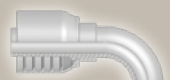
Page Db-15 – Db-17

<p>JC Db-15 Female ORFS Swivel – Straight Short ISO 12151-1 – SWSA SAE J516 – ORFS</p> 	<p>JS Db-15 ORFS Swivel Female (Long) ISO 12151-1-SWSB SAE J516 – ORFS</p> 	<p>J7 Db-16 Female ORFS – Swivel 45° Elbow ISO 12151-1 – SWE 45° SAE J516 – ORFS 45°</p> 	<p>J9 Db-16 Female ORFS – Swivel 90° Elbow – Short Drop ISO 12151-1 – SWES SAE J516 – ORFS 90°</p> 
<p>J1 Db-17 Female ORFS – Swivel 90° Elbow – Long Drop ISO 12151-1 – SWEL SAE J516 – ORFS 90° L</p> 	<p>JM Db-17 ORFS Male ISO 12151-1-S – SAE J516</p> 		

Others

Page Db-18

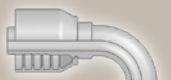
<p>XU Db-18 Female Metric – Swivel Straight (30° Flare) JIS B8363</p> 	<p>XY Db-18 Female Metric – Swivel 90° Elbow (30° Flare) JIS B8363</p> 
---	--

CA **Female Metric 24°
Light Series with O-Ring
Swivel – Straight**
ISO 12151-2-SWS-L – DKOL

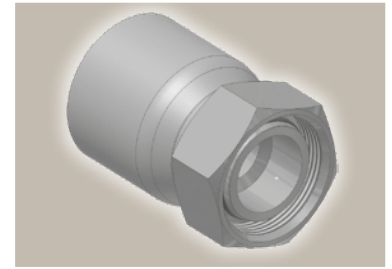
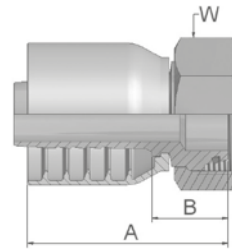

Part Number	Hose I.D.				Thread metric	Tube O.D. mm	A mm	B mm	W mm
	DN	Inch	Size	mm					
1CA70-10-6	10	3/8	-6	9.5	M16x1.5	10	54	25	19
1CA70-12-6	10	3/8	-6	9.5	M18x1.5	12	54	24	22
1CA70-15-8	12	1/2	-8	12.7	M22x1.5	15	62	27	27
1CA70-18-8	12	1/2	-8	12.7	M26x1.5	18	57	22	32
1CA70-15-10	16	5/8	-10	15.9	M22x1.5	15	67	28	27
1CA70-18-10	16	5/8	-10	15.9	M26x1.5	18	62	25	32
1CA70-22-10	16	5/8	-10	15.9	M30x2	22	64	24	36
1CA70-18-12	19	3/4	-12	19.1	M26x1.5	18	65	26	32
1CA70-22-12	19	3/4	-12	19.1	M30x2	22	63	24	36
1CA70-28-12	19	3/4	-12	19.1	M36x2	28	66	26	41
1CA70-28-16	25	1	-16	25.4	M36x2	28	78	33	41
1CA70-35-16	25	1	-16	25.4	M45x2	35	76	31	50

Fittings with standard O-ring seals can be used for temperatures from -40 °C up to +105 °C.
O-rings see section Eb. Special O-rings are available on request.

CE **Female Metric 24°
Light Series with O-Ring
Swivel – 45° Elbow**
ISO 12151-2-SWE -L – DKOL 45°

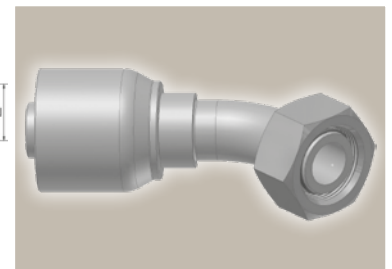
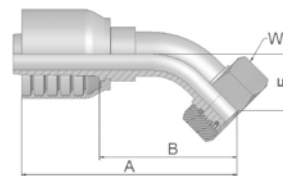

Part Number	Hose I.D.				Thread metric	Tube O.D. mm	A mm	B mm	E mm	W mm
	DN	Inch	Size	mm						
1CE70-12-6	10	3/8	-6	9.5	M18x1.5	12	70	40	20	22
1CE70-15-8	12	1/2	-8	12.7	M22x1.5	15	85	50	24	27
1CE70-18-10	16	5/8	-10	15.9	M26x1.5	18	89	49	23	32
1CE70-22-12	19	3/4	-12	19.1	M30x2	22	98	58	26	36
1CE70-28-16	25	1	-16	25.4	M36x2	28	127	80	34	41

Fittings with standard O-ring seals can be used for temperatures from -40 °C up to +105 °C.
O-rings see section Eb. Special O-rings are available on request.

Approved **fitting series** for hose types, depending on size:

70 | 371LT | 372 | 372RH | 372TC | 701 | 701 TC | F42-8

CF Female Metric 24° Light Series with O-Ring Swivel – 90° Elbow

ISO 12151-2-SWE-L – DKOL 90°

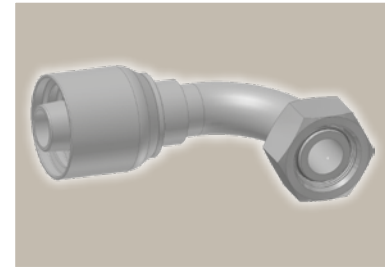
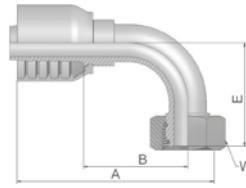

Part Number	Hose I.D.				Thread metric	Tube O.D. mm	A mm	B mm	E mm	W mm
	DN	Inch	Size	mm						
1CF70-10-6	10	3/8	-6	9.5	M16x1.5	10	67	38	39	19
1CF70-12-6	10	3/8	-6	9.5	M18x1.5	12	67	38	37	22
1CF70-15-8	12	1/2	-8	12.7	M22x1.5	15	73	39	45	27
1CF70-18-8	12	1/2	-8	12.7	M26x1.5	18	71	36	40	32
1CF70-15-10	16	5/8	-10	15.9	M22x1.5	15	79	42	51	27
1CF70-18-10	16	5/8	-10	15.9	M26x1.5	18	79	42	49	32
1CF70-18-12	19	3/4	-12	19.1	M26x1.5	18	89	49	56	32
1CF70-22-12	19	3/4	-12	19.1	M30x2	22	89	49	55	36
1CF70-28-16	25	1	-16	25.4	M36x2	28	114	68	78	41
1CF70-35-16	25	1	-16	25.4	M45x2	35	115	68	69	50

Fittings with standard O-ring seals can be used for temperatures from -40 °C up to +105 °C.
O-rings see section Eb. Special O-rings are available on request.

DO Male Metric 24° Light Series – Rigid Straight

ISO 12151-2-S-L – CEL

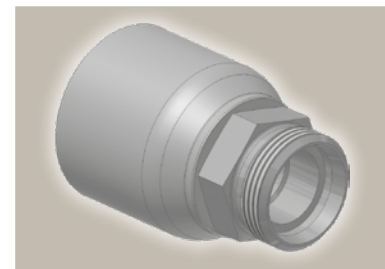
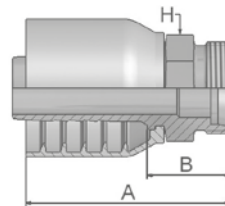

Part Number	Hose I.D.				Thread metric	Tube O.D. mm	A mm	B mm	H mm
	DN	Inch	Size	mm					
1D070-15-8	12	1/2	-8	12.7	M22x1.5	15	60	26	22
1D070-18-10	16	5/8	-10	15.9	M26x1.5	18	65	28	27
1D070-22-12	19	3/4	-12	19.1	M30x2	22	69	30	30
1D070-28-16	25	1	-16	25.4	M36x2	28	79	32	36

Approved **fitting series** for hose types, depending on size:

70 371LT 372 372RH 372TC 701 701 TC F42-8

C9 Female Metric 24° – Swivel Heavy Series with O-Ring Straight

ISO 12151-2-SWS-S – DKOS

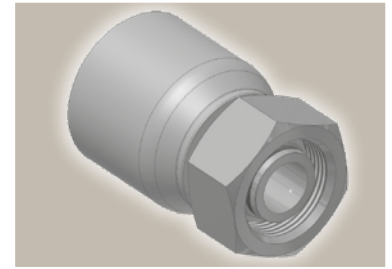
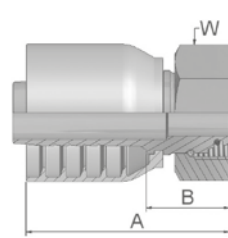

Part Number	Hose I.D.				Thread metric	Tube O.D. mm	A mm	B mm	W mm
	DN	Inch	Size	mm					
1C970-8-6	10	3/8	-6	9.5	M16x1.5	8	53	24	19
1C970-12-6	10	3/8	-6	9.5	M20x1.5	12	52	22	24
1C970-14-6	10	3/8	-6	9.5	M22x1.5	14	53	24	27
1C970-12-8	12	1/2	-8	12.7	M20x1.5	12	60	25	24
1C970-16-8	12	1/2	-8	12.7	M24x1.5	16	59	24	30
1C970-20-8	12	1/2	-8	12.7	M30x2	20	59	24	36
1C970-16-10	16	5/8	-10	15.9	M24x1.5	16	66	27	30
1C970-20-10	16	5/8	-10	15.9	M30x2	20	64	27	36
1C970-25-10	16	5/8	-10	15.9	M36x2	25	65	29	46
1C970-20-12	19	3/4	-12	19.1	M30x2	20	66	27	36
1C970-25-12	19	3/4	-12	19.1	M36x2	25	68	28	46
1C970-25-16	25	1	-16	25.4	M36x2	25	78	33	46
1C970-30-16	25	1	-16	25.4	M42x2	30	80	33	50

Fittings with standard O-ring seals can be used for temperatures from -40 °C up to +105 °C.
O-rings see section Eb. Special O-rings are available on request.

OC Female Metric 24° – Swivel Heavy Series with O-Ring 45° Elbow

ISO 12151-2 – SWE -S – DKOS 45°

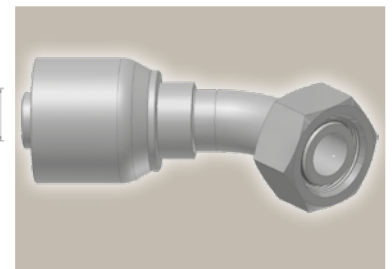
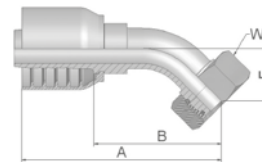

Part Number	Hose I.D.				Thread metric	Tube O.D. mm	A mm	B mm	E mm	W mm
	DN	Inch	Size	mm						
10C70-12-6	10	3/8	-6	9.5	M20x1.5	12	69	40	20	24
10C70-14-6	10	3/8	-6	9.5	M22x1.5	14	76	46	20	27
10C70-16-8	12	1/2	-8	12.7	M24x1.5	16	83	48	24	30
10C70-16-10	16	5/8	-10	15.9	M24x1.5	16	88	49	22	30
10C70-20-10	16	5/8	-10	15.9	M30x2	20	91	51	25	36
10C70-25-10	16	5/8	-10	15.9	M36x2	25	92	56	27	46
10C70-20-12	19	3/4	-12	19.1	M30x2	20	99	60	28	36
10C70-25-12	19	3/4	-12	19.1	M36x2	25	100	61	29	46
10C70-25-16	25	1	-16	25.4	M36x2	25	123	76	33	46
10C70-30-16	25	1	-16	25.4	M42x2	30	126	79	36	50

Fittings with standard O-ring seals can be used for temperatures from -40 °C up to +105 °C.
O-rings see section Eb. Special O-rings are available on request.

Approved **fitting series** for hose types, depending on size:

70 371LT 372 372RH 372TC 701 701 TC F42-8

1C Female Metric 24° – Swivel Heavy Series with O-Ring 90° Elbow

ISO 12151-2-SWE-S – DKOS 90°

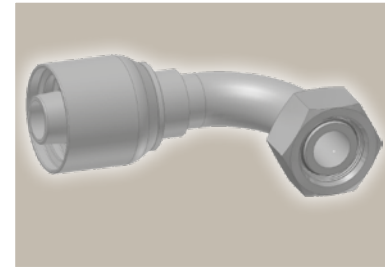
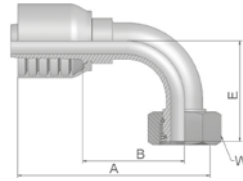

Part Number	Hose I.D.				Thread metric	Tube O.D. mm	A mm	B mm	E mm	W mm
	DN	Inch	Size	mm						
11C70-8-6	10	3/8	-6	9.5	M16x1.5	8	67	38	37	19
11C70-12-6	10	3/8	-6	9.5	M20x1.5	12	67	38	37	24
11C70-14-6	10	3/8	-6	9.5	M22x1.5	14	64	35	37	27
11C70-16-8	12	1/2	-8	12.7	M24x1.5	16	72	37	45	30
11C70-20-8	12	1/2	-8	12.7	M30x2	20	75	40	46	36
11C70-16-10	16	5/8	-10	15.9	M24x1.5	16	79	40	45	30
11C70-20-10	16	5/8	-10	15.9	M30x2	20	79	40	48	36
11C70-25-10	16	5/8	-10	15.9	M36x2	25	85	45	52	46
11C70-20-12	19	3/4	-12	19.1	M30x2	20	89	50	58	36
11C70-25-12	19	3/4	-12	19.1	M36x2	25	89	49	59	46
11C70-30-12	19	3/4	-12	19.1	M42x2	30	89	50	60	50
11C70-25-16	25	1	-16	25.4	M36x2	25	109	64	69	46
11C70-30-16	25	1	-16	25.4	M42x2	30	115	68	76	50

Fittings with standard O-ring seals can be used for temperatures from -40 °C up to +105 °C.
O-rings see section Eb. Special O-rings are available on request.

D2 Male Metric 24° – Rigid Heavy Series – Straight

ISO 12151-2-S-S – CES

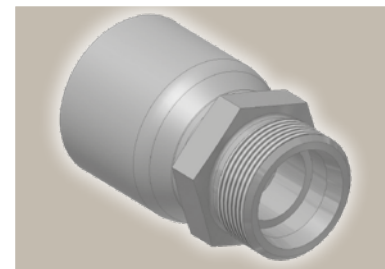
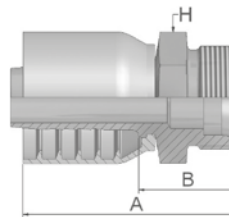

Part Number	Hose I.D.				Thread metric	Tube O.D. mm	A mm	B mm	H mm
	DN	Inch	Size	mm					
1D270-12-6	10	3/8	-6	9.5	M20x1.5	12	53	24	22
1D270-14-6	10	3/8	-6	9.5	M22x1.5	14	55	25	22
1D270-16-8	12	1/2	-8	12.7	M24x1.5	16	62	28	24
1D270-20-8	12	1/2	-8	12.7	M30x2	20	67	32	30
1D270-20-10	16	5/8	-10	15.9	M30x2	20	75	32	30
1D270-20-12	19	3/4	-12	19.1	M30x2	20	72	33	30
1D270-25-12	19	3/4	-12	19.1	M36x2	25	74	35	36
1D270-25-16	25	1	-16	25.4	M36x2	25	84	37	36
1D270-30-16	25	1	-16	25.4	M42x2	30	85	40	46

Approved **fitting series** for hose types, depending on size:

70 371LT 372 372RH 372TC 701 701 TC F42-8

92 Female BSP Parallel Pipe Swivel – Straight (60° Cone)

BS5200-A – DKR

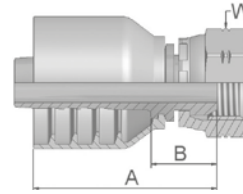

Part Number	Hose I.D.				Thread BSP	A mm	B mm	W mm
	DN	Inch	Size	mm				
19270-6-6	10	3/8	-6	9.5	3/8x19	49	20	22
19270-8-6	10	3/8	-6	9.5	1/2x14	51	22	27
19270-8-8	12	1/2	-8	12.7	1/2x14	57	22	27
19270-10-8	12	1/2	-8	12.7	5/8x14	55	20	30
19270-10-10	16	5/8	-10	15.9	5/8x14	57	21	30
19270-12-10	16	5/8	-10	15.9	3/4x14	61	22	32
19270-12-12	19	3/4	-12	19.1	3/4x14	61	22	32
19270-16-12	19	3/4	-12	19.1	1x11	63	24	41
19270-16-16	25	1	-16	25.4	1x11	72	25	41

B1 Female BSP Parallel Pipe Swivel 45° Elbow (60° Cone)

BS 5200-D – DKR 45°

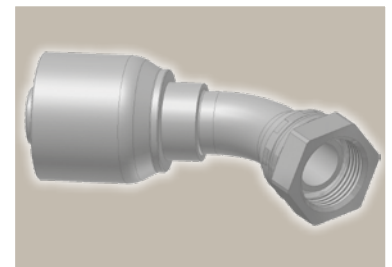
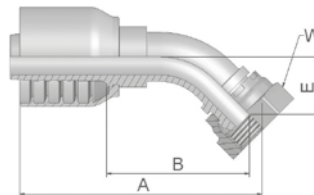

Part Number	Hose I.D.				Thread BSP	A mm	B mm	E mm	W mm
	DN	Inch	Size	mm					
1B170-4-6	10	3/8	-6	9.5	1/4x19	68	39	19	19
1B170-6-6	10	3/8	-6	9.5	3/8x19	67	37	17	22
1B170-8-6	10	3/8	-6	9.5	1/2x14	68	39	19	27
1B170-8-8	12	1/2	-8	12.7	1/2x14	79	45	20	27
1B170-10-8	12	1/2	-8	12.7	5/8x14	78	43	19	30
1B170-10-10	16	5/8	-10	15.9	5/8x14	89	50	23	30
1B170-12-10	16	5/8	-10	15.9	3/4x14	88	49	22	32
1B170-12-12	19	3/4	-12	19.1	3/4x14	96	57	25	32
1B170-16-12	19	3/4	-12	19.1	1x11	95	56	24	41
1B170-16-16	25	1	-16	25.4	1x11	121	77	33	41

Approved **fitting series** for hose types, depending on size:

70 371LT 372 372RH 372TC 701 701 TC F42-8

B2 Female BSP Parallel Pipe Swivel 90° Elbow (60° Cone)

BS 5200-B – DKR 90°

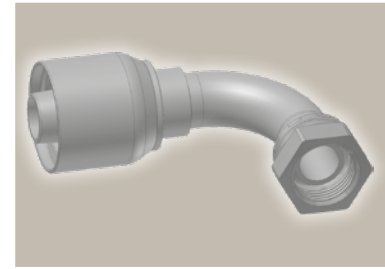
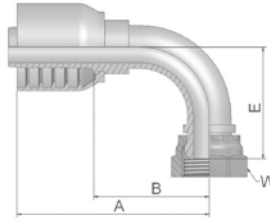

Part Number	Hose I.D.				Thread BSP	A mm	B mm	E mm	W mm
	DN	Inch	Size	mm					
1B270-6-6	10	3/8	-6	9.5	3/8x19	66	37	33	22
1B270-8-6	10	3/8	-6	9.5	1/2x14	66	37	35	27
1B270-8-8	12	1/2	-8	12.7	1/2x14	70	35	39	27
1B270-10-8	12	1/2	-8	12.7	5/8x14	74	39	38	30
1B270-10-10	16	5/8	-10	15.9	5/8x14	81	41	46	30
1B270-12-10	16	5/8	-10	15.9	3/4x14	92	52	59	32
1B270-16-10	16	5/8	-10	15.9	1x11	86	46	44	41
1B270-12-12	19	3/4	-12	19.1	3/4x14	89	50	53	32
1B270-16-12	19	3/4	-12	19.1	1x11	89	49	51	41
1B270-16-16	25	1	-16	25.4	1x11	116	69	69	41

EA BSP Swivel Female with O-Ring (60° Cone)

BS 5200 – ISO 12151-6 – DKOR

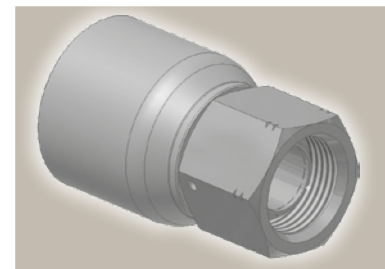
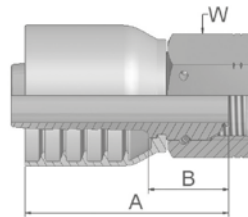

Part Number	Hose I.D.				Thread BSP	A mm	B mm	W mm
	DN	Inch	Size	mm				
1EA70-8-8	12	1/2	-8	12.7	1/2x14	56	21	27
1EA70-12-12	19	3/4	-12	19.1	3/4x14	63	23	32
1EA70-16-16	25	1	-16	25.4	1x11	77	31	41

Fittings with standard O-ring seals can be used for temperatures from -40 °C up to +105 °C. O-rings see section Eb. Special O-rings are available on request.

Approved **fitting series** for hose types, depending on size:

70 371LT 372 372RH 372TC 701 701 TC F42-8

EC

**BSP Swivel Female
with O-Ring
90° Elbow (60° Cone)**

BS 5200 – ISO 12151-6 – DKOR 90°

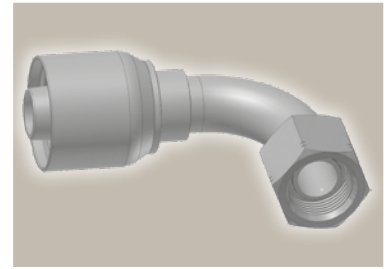
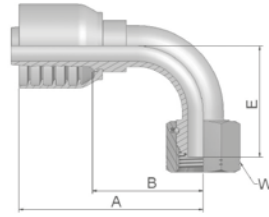

Part Number	Hose I.D.				Thread BSP	A mm	B mm	E mm	W mm
	DN	Inch	Size	mm					
1EC70-8-8	12	1/2	-8	12.7	1/2x14	71	36	40	27
1EC70-12-12	19	3/4	-12	19.1	3/4x14	89	49	55	32
1EC70-16-16	25	1	-16	25.4	1x11	115	68	71	41

Fittings with standard O-ring seals can be used for temperatures from -40 °C up to +105 °C.
O-rings see section Eb. Special O-rings are available on request.

D9

**Male BSP Parallel Pipe
Rigid – Straight (60° Cone)**

BS5200 – AGR

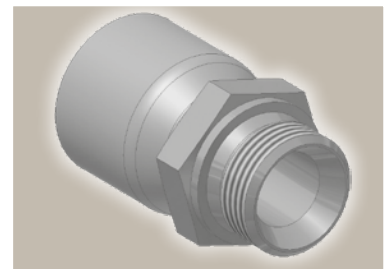
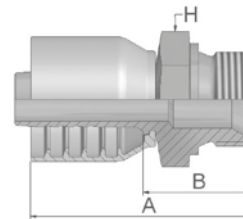

Part Number	Hose I.D.				Thread BSP	A mm	B mm	H mm
	DN	Inch	Size	mm				
1D970-6-6	10	3/8	-6	9.5	3/8x19	57	28	22
1D970-8-6	10	3/8	-6	9.5	1/2x14	60	31	27
1D970-8-8	12	1/2	-8	12.7	1/2x14	62	28	27
1D970-10-8	12	1/2	-8	12.7	5/8x14	70	36	30
1D970-12-8	12	1/2	-8	12.7	3/4x14	69	35	32
1D970-10-10	16	5/8	-10	15.9	5/8x14	75	36	30
1D970-12-10	16	5/8	-10	15.9	3/4x14	72	35	32
1D970-12-12	19	3/4	-12	19.1	3/4x14	72	33	32
1D970-16-12	19	3/4	-12	19.1	1x11	77	38	41
1D970-16-16	25	1	-16	25.4	1x11	85	40	41

Approved **fitting series** for hose types, depending on size:

70 371LT 372 372RH 372TC 701 701 TC F42-8

01 Male NPTF Pipe Rigid – Straight

SAE J476A / J516 – AGN

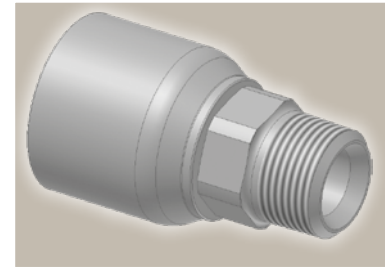
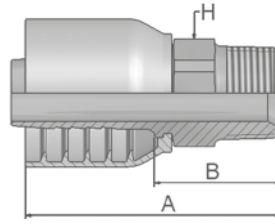

Part Number	Hose I.D.				Thread NPTF	A mm	B mm	H mm
	DN	Inch	Size	mm				
10170-6-6-SM	10	3/8	-6	9.5	3/8-18	60	31	19
10170-12-8-SM	12	1/2	-8	12.7	3/4-14	68	33	27
10170-8-10-SM	16	5/8	-10	15.9	1/2-14	75	38	24
10170-12-10-SM	16	5/8	-10	15.9	3/4-14	71	34	27
10170-12-12-SM	19	3/4	-12	19.1	3/4-14	79	39	27
10170-16-12-SM	19	3/4	-12	19.1	1-11 1/2	79	39	36

03 Male JIC 37° – Rigid Straight

ISO12151-5-S – AGJ

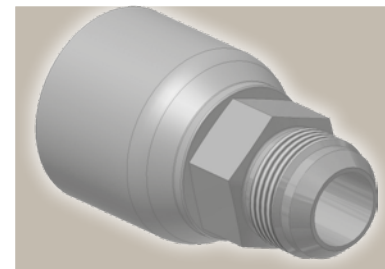
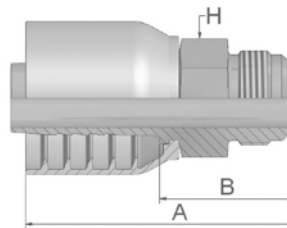

Part Number	Hose I.D.				Thread UNF	A mm	B mm	H mm
	DN	Inch	Size	mm				
10370-6-6-SM	10	3/8	-6	9.5	9/16x18	60	31	19
10370-8-6-SM	10	3/8	-6	9.5	3/4x16	59	29	19
10370-8-8-SM	12	1/2	-8	12.7	3/4x16	68	33	22
10370-10-8-SM	12	1/2	-8	12.7	7/8x14	68	34	24
10370-12-8-SM	12	1/2	-8	12.7	1 1/16x12	71	36	27
10370-10-10-SM	16	5/8	-10	15.9	7/8x14	75	38	24
10370-12-10-SM	16	5/8	-10	15.9	1 1/16x12	78	39	27
10370-12-12-SM	19	3/4	-12	19.1	1 1/16x12	82	42	27
10370-16-12-SM	19	3/4	-12	19.1	1 5/16x12	81	43	36
10370-16-16-SM	25	1	-16	25.4	1 5/16x12	94	47	36

Approved **fitting series** for hose types, depending on size:

70 371LT 372 372RH 372TC 701 701 TC F42-8

06

**Female JIC 37° – Swivel
Straight**

ISO12151-5-SWS – DKJ

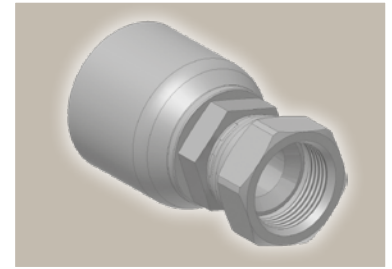
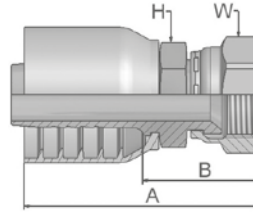

Part Number	Hose I.D.				Thread UNF	A mm	B mm	H mm	W mm
	DN	Inch	Size	mm					
10670-6-6-SM	10	3/8	-6	9.5	9/16x18	58	29	17	19
10670-8-6-SM	10	3/8	-6	9.5	3/4x16	61	32	19	22
10670-8-8-SM*	12	1/2	-8	12.7	3/4x16	67	32	22	22
10670-12-8-SM	12	1/2	-8	12.7	1 1/16x12	71	36	27	32
10670-10-10-SM	16	5/8	-10	15.9	7/8x14	75	35	24	27
10670-12-10-SM	16	5/8	-10	15.9	1 1/16x12	79	39	27	32
10670-12-12-SM	19	3/4	-12	19.1	1 1/16x12	80	41	27	32
10670-14-12-SM	19	3/4	-12	19.1	1 3/16x12	81	42	32	36
10670-16-12-SM	19	3/4	-12	19.1	1 5/16x12	84	45	32	41
10670-12-16-SM	25	1	-16	25.4	1 1/16x12	89	44	36	32
10670-16-16-SM	25	1	-16	25.4	1 5/16x12	94	47	36	41
10670-20-16-SM	25	1	-16	25.4	1 5/8x12	98	52	41	50

* These fittings contain a dual seat that accepts both JIC (37°) and SAE (45°) male configurations.

Approved **fitting series** for **hose types**, depending on size:

70	371LT	372	372RH	372TC	701	701 TC	F42-8
----	-------	-----	-------	-------	-----	--------	-------

37 Female JIC 37° – Swivel 45° Elbow

ISO 12151-5-SWE 45° – DKJ 45°

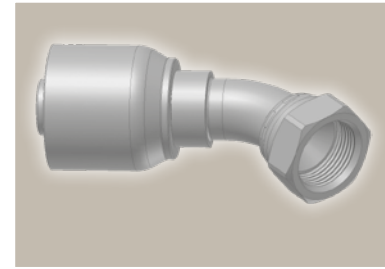
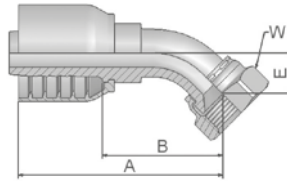

Part Number	Hose I.D.				Thread UNF	A mm	B mm	E mm	W mm
	DN	Inch	Size	mm					
13770-6-6-SM	10	3/8	-6	9.5	9/16x18	61	32	11	19
13770-8-8-SM*	12	1/2	-8	12.7	3/4x16	73	38	14	22
13770-10-8-SM*	12	1/2	-8	12.7	7/8x14	78	43	17	27
13770-8-10-SM*	16	5/8	-10	15.9	3/4x16	78	39	15	22
13770-10-10-SM*	16	5/8	-10	15.9	7/8x14	83	42	16	27
13770-12-10-SM	16	5/8	-10	15.9	1 1/16x12	88	48	21	32
13770-12-12-SM	19	3/4	-12	19.1	1 1/16x12	91	52	20	32
13770-16-16-SM	25	1	-16	25.4	1 5/16x12	111	66	24	41
13770-20-16-SM	25	1	-16	25.4	1 5/8x12	114	67	26	50

* These fittings contain a dual seat that accepts both JIC (37°) and SAE (45°) male configurations.

39/3W Female JIC 37° SAE 45° – Dual Flare Swivel Female 90° Elbow

ISO 12151-5-SWES – DKJ 90°

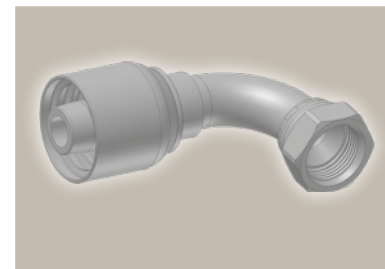
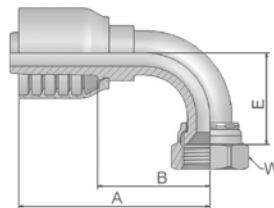

Part Number	Hose I.D.				Thread UNF	A mm	B mm	E mm	W mm
	DN	Inch	Size	mm					
13970-6-6-SM	10	3/8	-6	9.5	9/16x18	57	28	23	19
13W70-8-6-SM	10	3/8	-6	9.5	3/4x16	64	35	29	22
13970-12-10-SM	16	5/8	-10	15.9	1 1/16x12	87	48	48	32
13970-12-12-SM	19	3/4	-12	19.1	1 1/16x12	89	50	48	32
13970-16-12-SM	19	3/4	-12	19.1	1 5/16x12	89	50	51	41
13970-12-16-SM	25	1	-16	25.4	1 1/16x12	99	54	46	32
13970-16-16-SM	25	1	-16	25.4	1 5/16x12	109	64	56	41
13970-20-16-SM	25	1	-16	25.4	1 5/8x12	111	64	62	50

* These fittings contain a dual seat that accepts both JIC (37°) and SAE (45°) male configurations.

Approved **fitting series** for hose types, depending on size:

70 371LT 372 372RH 372TC 701 701 TC F42-8

15 ISO 6162-1-Flange Straight

ISO 12151-3-S-L – SFL
(21.0 MPa/ 3000 psi)

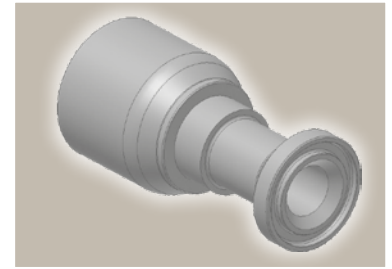
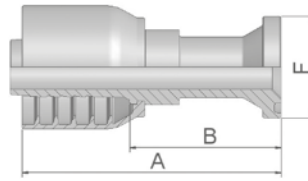

Part Number	Hose I.D.				Flange Inch	A mm	B mm	F mm
	DN	Inch	Size	mm				
11570-8-8	12	1/2	-8	12.7	1/2	89	54	30
11570-10-10	16	5/8	-10	15.9	5/8	116	79	34
11570-12-10	16	5/8	-10	15.9	3/4	69	30	38
11570-12-12	19	3/4	-12	19.1	3/4	98	59	38
11570-16-12	19	3/4	-12	19.1	1	70	31	45
11570-20-12	19	3/4	-12	19.1	1 1/4	75	36	51
11570-12-16	25	1	-16	25.4	3/4	111	66	38
11570-16-16	25	1	-16	25.4	1	108	63	45
11570-20-16	25	1	-16	25.4	1 1/4	82	36	51

SAE flange halves see in section Eb.

Fittings with standard O-ring seals can be used for temperatures from -40 °C up to +105 °C.

O-rings see section Eb. Special O-rings are available on request.

17 ISO 6162-1 Flange 45° Elbow

ISO 12151-3 – E45 – L – SFL 45°
(21.0 MPa/ 3000 psi)

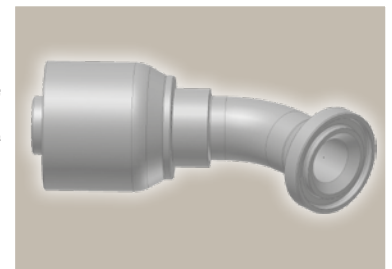
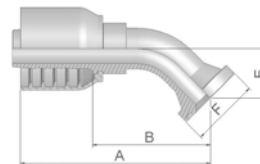

Part Number	Hose I.D.				Flange Inch	A mm	B mm	E mm	F mm
	DN	Inch	Size	mm					
11770-8-8	12	1/2	-8	12.7	1/2	79	44	20	30
11770-10-10	16	5/8	-10	15.9	5/8	104	67	24	34
11770-12-10	16	5/8	-10	15.9	3/4	96	57	26	38
11770-12-12	19	3/4	-12	19.1	3/4	98	58	26	38
11770-16-12	19	3/4	-12	19.1	1	97	57	25	45
11770-16-16	25	1	-16	25.4	1	119	73	27	45
11770-20-16	25	1	-16	25.4	1 1/4	121	76	32	51

SAE flange halves see in section Eb.

Fittings with standard O-ring seals can be used for temperatures from -40 °C up to +105 °C.

O-rings see section Eb. Special O-rings are available on request.

Approved **fitting series** for hose types, depending on size:

70 371LT 372 372RH 372TC 701 701 TC F42-8

19 ISO 6162-1-Flange 90° Elbow

ISO 12151-3 – E- L – SFL 90°
(21.0 MPa/ 3000 psi)

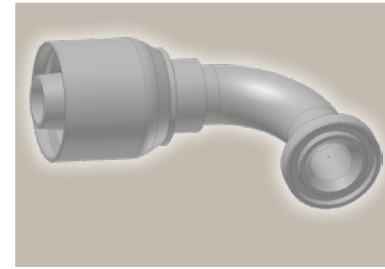
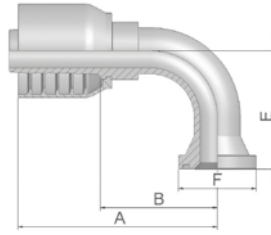

Part Number	Hose I.D.				Flange Inch	A mm	B mm	E mm	F mm
	DN	Inch	Size	mm					
11970-8-8	12	1/2	-8	12.7	1/2	75	40	41	30
11970-12-8	12	1/2	-8	12.7	3/4	77	42	42	38
11970-10-10	16	5/8	-10	15.9	5/8	92	55	55	34
11970-12-10	16	5/8	-10	15.9	3/4	95	65	54	38
11970-12-12	19	3/4	-12	19.1	3/4	89	50	58	38
11970-16-12	19	3/4	-12	19.1	1	90	50	58	45
11970-16-16	25	1	-16	25.4	1	105	55	61	45
11970-20-16	25	1	-16	25.4	1 1/4	113	68	70	51

SAE flange halves see in section Eb.

Fittings with standard O-ring seals can be used for temperatures from -40 °C up to +105 °C.
O-rings see section Eb. Special O-rings are available on request.

6A ISO 6162-2-Flange Straight

ISO 12151-3-S-S – SFS
(42.0 MPa/ 6000 psi)

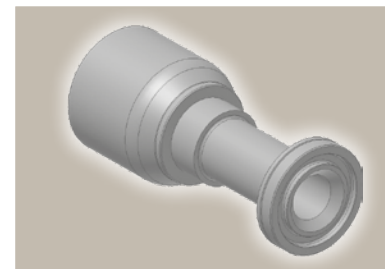
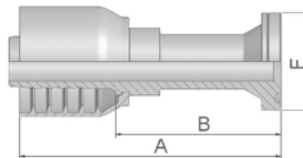

Part Number	Hose I.D.				Flange Inch	A mm	B mm	F mm
	DN	Inch	Size	mm				
16A70-8-8	12	1/2	-8	12.7	1/2	103	68	32
16A70-12-8	12	1/2	-8	12.7	3/4	105	70	41
16A70-8-10	16	5/8	-10	15.9	1/2	107	68	32
16A70-12-10	16	5/8	-10	15.9	3/4	117	78	41
16A70-8-12	19	3/4	-12	19.1	1/2	107	67	32
16A70-12-12	19	3/4	-12	19.1	3/4	105	66	41
16A70-16-12	19	3/4	-12	19.1	1	110	70	48
16A70-12-16	25	1	-16	25.4	3/4	127	82	41
16A70-16-16	25	1	-16	25.4	1	127	82	48
16A70-20-16	25	1	-16	25.4	1 1/4	127	82	54

SAE flange halves see in section Eb.

Fittings with standard O-ring seals can be used for temperatures from -40 °C up to +105 °C.
O-rings see section Eb. Special O-rings are available on request.

Approved **fitting series** for hose types, depending on size:

70 371LT 372 372RH 372TC 701 701 TC F42-8

6F ISO 6162-2-Flange 45° Elbow – Heavy Series

ISO 12151-3 – E45-S – SFS 45°
(42.0 MPa/ 6000 psi)

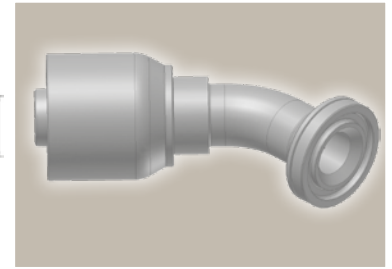
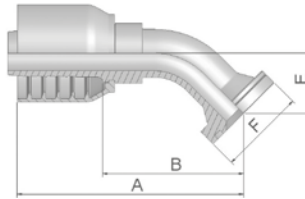

Part Number	Hose I.D.				Flange Inch	A mm	B mm	E mm	F mm
	DN	Inch	Size	mm					
16F70-8-8	12	1/2	-8	12.7	1/2	81	46	19	32
16F70-12-8	12	1/2	-8	12.7	3/4	90	55	26	41
16F70-8-10	16	5/8	-10	15.9	1/2	92	53	26	32
16F70-12-10	16	5/8	-10	15.9	3/4	92	55	26	41
16F70-8-12	19	3/4	-12	19.1	1/2	94	54	26	32
16F70-12-12	19	3/4	-12	19.1	3/4	105	66	26	41
16F70-16-12	19	3/4	-12	19.1	1	101	62	26	48
16F70-12-16	25	1	-16	25.4	3/4	118	73	27	41
16F70-16-16	25	1	-16	25.4	1	117	77	27	48
16F70-20-16	25	1	-16	25.4	1 1/4	117	70	31	54

SAE flange halves see in section Eb.

Fittings with standard O-ring seals can be used for temperatures from -40 °C up to +105 °C.
O-rings see section Eb. Special O-rings are available on request.

6N ISO 6162-2-Flange 90° Elbow

ISO 12151-3 – E-S – SFS 90°
(42.0 MPa/ 6000 psi)

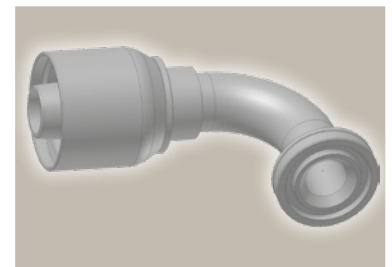
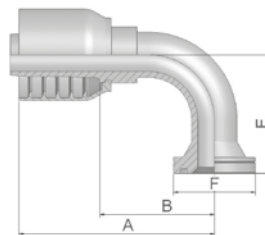

Part Number	Hose I.D.				Flange Inch	A mm	B mm	E mm	F mm
	DN	Inch	Size	mm					
16N70-8-8	12	1/2	-8	12.7	1/2	74	39	41	32
16N70-12-8	12	1/2	-8	12.7	3/4	79	44	45	41
16N70-8-10	16	5/8	-10	15.9	1/2	95	56	54	32
16N70-12-10	16	5/8	-10	15.9	3/4	92	55	54	41
16N70-16-10	16	5/8	-10	15.9	1	86	46	54	48
16N70-8-12	19	3/4	-12	19.1	1/2	81	42	54	32
16N70-12-12	19	3/4	-12	19.1	3/4	98	58	54	41
16N70-16-12	19	3/4	-12	19.1	1	92	53	53	48
16N70-12-16	25	1	-16	25.4	3/4	113	66	57	41
16N70-16-16	25	1	-16	25.4	1	111	64	70	48
16N70-20-16	25	1	-16	25.4	1 1/4	115	68	68	54

SAE flange halves see in section Eb.

Fittings with standard O-ring seals can be used for temperatures from -40 °C up to +105 °C.
O-rings see section Eb. Special O-rings are available on request.

Approved **fitting series** for hose types, depending on size:

70 371LT 372 372RH 372TC 701 701 TC F42-8

PY Flange – 24° Male
French Gas
Straight

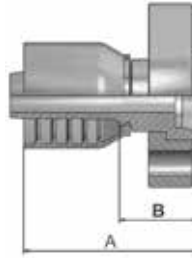

Part Number	 Hose I.D.				A mm	B mm
	DN	Inch	Size	mm		
1PY70-10-10	16	5/8	-10	15.9	63	24
1PY70-12-12	19	3/4	-12	19.1	69	30
1PY70-16-16	25	1	-16	25.4	87	41

Approved **fitting series** for **hose types**, depending on size:

70 371LT 372 372RH 372TC 701 701 TC F42-8

JC

Female ORFS Swivel – Straight Short

ISO 12151-1 – SWSA
SAE J516 – ORFS

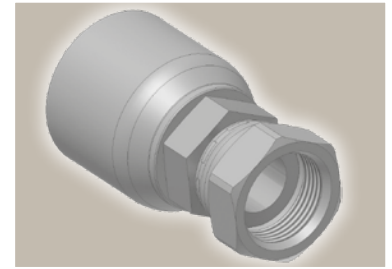
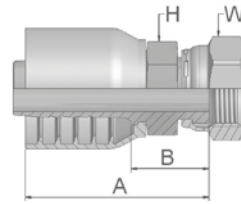

Part Number	Hose I.D.				Thread UNF	A mm	B mm	H mm	W mm
	DN	Inch	Size	mm					
1JC70-6-6-SM	10	3/8	-6	9.5	11/16x16	49	20	19	22
1JC70-8-6-SM	10	3/8	-6	9.5	13/16x16	51	22	19	24
1JC70-8-8-SM	12	1/2	-8	12.7	13/16x16	56	24	13/16	15/16
1JC70-10-8-SM	12	1/2	-8	12.7	1x14	58	24	24	30
1JC70-12-8-SM	12	1/2	-8	12.7	1 3/16x12	63	28	32	36
1JC70-8-10-SM	16	5/8	-10	15.9	13/16x16	58	22	24	24
1JC70-10-10-SM	16	5/8	-10	15.9	1x14	64	24	24	30
1JC70-12-10-SM	16	5/8	-10	15.9	1 3/16x12	68	29	32	36
1JC70-8-12-SM	19	3/4	-12	19.1	13/16x16	61	22	27	24
1JC70-12-12-SM	19	3/4	-12	19.1	1 3/16x12	68	29	32	36
1JC70-16-12-SM	19	3/4	-12	19.1	1 7/16x12	72	33	36	41
1JC70-12-16-SM	25	1	-16	25.4	13/16x12	76	31	36	36
1JC70-16-16-SM	25	1	-16	25.4	1 7/16x12	80	35	36	41
1JC70-20-16-SM	25	1	-16	25.4	1 11/16x12	80	33	41	50

JS

ORFS Swivel Female (Long)

ISO 12151-1-SWSB
SAE J516 – ORFS

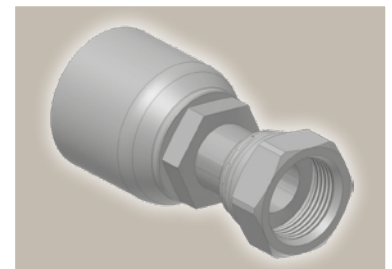
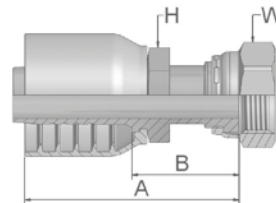

Part Number	Hose I.D.				Thread UNF	A mm	B mm	H mm	W mm
	DN	Inch	Size	mm					
1JS70-6-6-SM	10	3/8	-6	9.5	11/16x16	58	29	17	22
1JS70-8-6-SM	10	3/8	-6	9.5	13/16x16	64	35	19	24
1JS70-8-8-SM	12	1/2	-8	12.7	13/16x16	67	33	22	24
1JS70-10-8-SM	12	1/2	-8	12.7	1x14	73.5	38.5	24	30
1JS70-10-10-SM	16	5/8	-10	15.9	1x14	79	39	24	30
1JS70-12-12-SM	19	3/4	-12	19.1	1 3/16x12	84	45	30	36
1JS70-16-12-SM	19	3/4	-12	19.1	1 7/16x12	86	47	36	41
1JS70-16-16-SM	25	1	-16	25.4	1 7/16x12	98	53	36	41
1JS70-20-16-SM	25	1	-16	25.4	1 11/16x12	94	47	41	50

Approved **fitting series** for hose types, depending on size:

70 371LT 372 372RH 372TC 701 701 TC F42-8

J7 Female ORFS – Swivel 45° Elbow

ISO 12151-1 – SWE 45°
SAE J516 – ORFS 45°

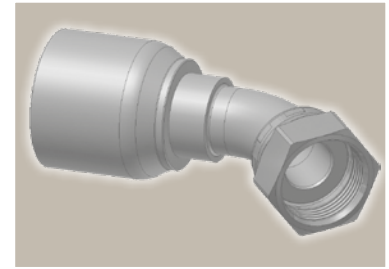
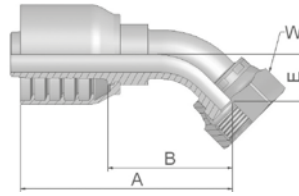

Part Number	Hose I.D.				Thread UNF	A mm	B mm	E mm	W mm
	DN	Inch	Size	mm					
1J770-6-6-SM	10	3/8	-6	9.5	11/16x16	62	33	11	22
1J770-8-6-SM	10	3/8	-6	9.5	13/16x16	64	35	15	24
1J770-6-8-SM	12	1/2	-8	12.7	11/16x16	68	33	11	22
1J770-8-8-SM	12	1/2	-8	12.7	13/16x16	72	37	15	24
1J770-10-8-SM	12	1/2	-8	12.7	1x14	80	46	17	30
1J770-10-10-SM	16	5/8	-10	15.9	1x14	83	44	16	30
1J770-12-10-SM	16	5/8	-10	15.9	1 3/16x12	90	53	21	36
1J770-12-12-SM	19	3/4	-12	19.1	1 3/16x12	92	53	21	36
1J770-16-12-SM	19	3/4	-12	19.1	1 7/16x12	95	56	24	41
1J770-16-16-SM	25	1	-16	25.4	1 7/16x12	113	66	24	41

J9 Female ORFS – Swivel 90° Elbow – Short Drop

ISO 12151-1 – SWES
SAE J516 – ORFS 90°

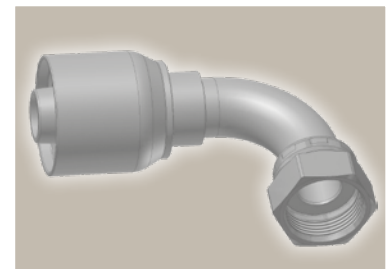
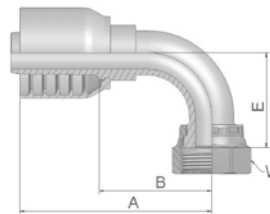

Part Number	Hose I.D.				Thread UNF	A mm	B mm	E mm	W mm
	DN	Inch	Size	mm					
1J970-6-6-SM	10	3/8	-6	9.5	11/16x16	58	29	23	22
1J970-8-6-SM	10	3/8	-6	9.5	13/16x16	58	29	29	24
1J970-8-8-SM	12	1/2	-8	12.7	13/16x16	70	35	29	24
1J970-10-8-SM	12	1/2	-8	12.7	1x14	73	38	32	30
1J970-12-8-SM	12	1/2	-8	12.7	1 3/16x12	76	41	48	36
1J970-10-10-SM	16	5/8	-10	15.9	1x14	78	39	33	30
1J970-12-10-SM	16	5/8	-10	15.9	1 3/16x12	86	50	48	36
1J970-12-12-SM	19	3/4	-12	19.1	1 3/16x12	89	49	48	36
1J970-16-12-SM	19	3/4	-12	19.1	1 7/16x12	89	49	56	41
1J970-16-16-SM	25	1	-16	25.4	1 7/16x12	111	64	56	41
1J970-20-16-SM	25	1	-16	25.4	1 11/16x12	111	64	64	50

Approved **fitting series** for hose types, depending on size:

70 371LT 372 372RH 372TC 701 701 TC F42-8

J1 Female ORFS – Swivel 90° Elbow – Long Drop

ISO 12151-1 – SWEL
SAE J 516 – ORFS 90° L

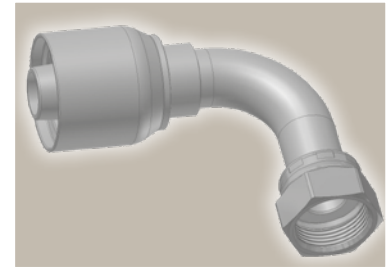
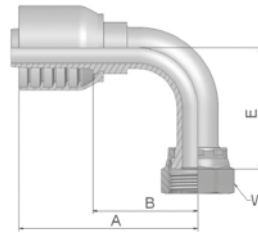

Part Number	Hose I.D.				Thread UNF	A mm	B mm	E mm	W mm
	DN	Inch	Size	mm					
1J170-8-8-SM	12	1/2	-8	12.7	13/16x16	71	36	64	24
1J170-10-8-SM	12	1/2	-8	12.7	1x14	73	38	70	30
1J170-10-10-SM	16	5/8	-10	15.9	1x14	78	39	70	30
1J170-12-10-SM	16	5/8	-10	15.9	1 3/16x12	76	40	96	36
1J170-12-12-SM	19	3/4	-12	19.1	1 3/16x12	89	49	96	36
1J170-16-16-SM	25	1	-16	25.4	1 7/16x12	109	64	114	41

JM ORFS Male

ISO 12151-1-S – SAE J516

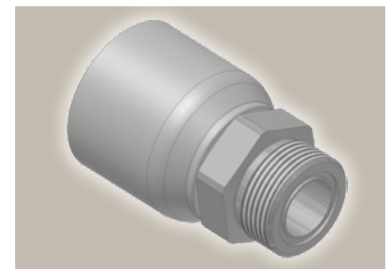
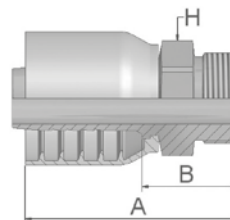

Part Number	Hose I.D.				Thread UNF	A mm	B mm	H mm
	DN	Inch	Size	mm				
1JM70-6-6-SM	10	3/8	-6	9.5	11/16x16	53	24	19
1JM70-8-6-SM	10	3/8	-6	9.5	13/16x16	56	27	22
1JM70-8-8-SM	12	1/2	-8	12.7	13/16x16	62	27	22
1JM70-10-8-SM	12	1/2	-8	12.7	1x14	66	32	27
1JM70-10-10-SM	16	5/8	-10	15.9	1x14	68	32	27
1JM70-12-10-SM	16	5/8	-10	15.9	1 3/16x12	71	34	32
1JM70-12-12-SM	19	3/4	-12	19.1	1 3/16x12	74	34	32
1JM70-16-12-SM	19	3/4	-12	19.1	1 7/16x12	74	35	41
1JM70-16-16-SM	25	1	-16	25.4	1 7/16x12	84	39	41
1JM70-20-16-SM	25	1	-16	25.4	1 11/16x12	82	37	46

JM fittings are supplied without O-ring.
O-rings see section Eb. Special O-rings are available on request.

Approved **fitting series** for hose types, depending on size:

70 | 371LT | 372 | 372RH | 372TC | 701 | 701 TC | F42-8

XU Female Metric – Swivel Straight (30° Flare)

JIS B8363

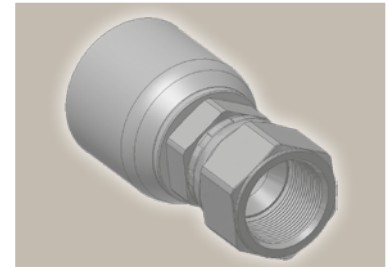
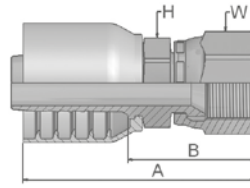

Part Number	Hose I.D.				Thread metric	A mm	B mm	H mm	W mm
	DN	Inch	Size	mm					
1XU70-10-10	16	5/8	-10	15.9	M24x1.5	67	28	30	32
1XU70-12-12	19	3/4	-12	19.1	M30x1.5	68	28	32	36
1XU70-16-16	25	1	-16	25.4	M33x1.5	82	35	36	41

XY Female Metric – Swivel 90° Elbow (30° Flare)

JIS B8363

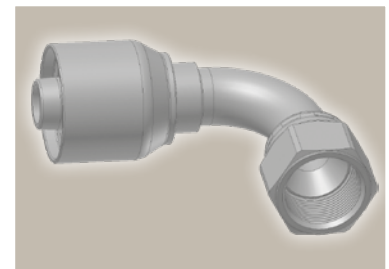
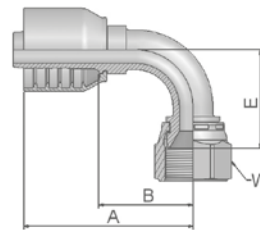





Part Number	Hose I.D.				Thread metric	A mm	B mm	E mm	W mm
	DN	Inch	Size	mm					
1XY70-10-10	16	5/8	-10	15.9	M24x1.5	77	41	41	32
1XY70-12-12	19	3/4	-12	19.1	M24x1.5	89	49	52	36

Approved **fitting series** for hose types, depending on size:

70 371LT 372 372RH 372TC 701 701 TC F42-8

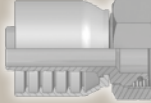
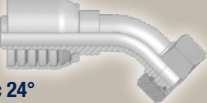

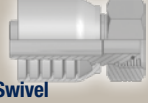
DIN – Metric

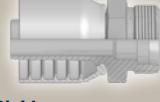
Page Dc-1 – Dc-4

<p>CA Dc-1</p>  <p>Female Metric 24° Light Series with O-Ring Swivel – Straight ISO 12151-2-SWS-L – DKOL</p>	<p>CE Dc-1</p>  <p>Female Metric 24° Light Series with O-Ring Swivel – 45° Elbow ISO 12151-2-SWE-L – DKOL 45°</p>	<p>CF Dc-2</p>  <p>Female Metric 24° Light Series with O-Ring Swivel – 90° Elbow ISO 12151-2-SWE-L – DKOL 90°</p>	<p>C9 Dc-2</p>  <p>Female Metric 24° – Swivel Heavy Series with O-Ring Straight ISO 12151-2-SWS-S – DKOS</p>
<p>OC Dc-3</p>  <p>Female Metric 24° – Swivel Heavy Series with O-Ring 45° Elbow ISO 12151-2 – SWE-S – DKOS 45°</p>	<p>1C Dc-3</p>  <p>Female Metric 24° – Swivel Heavy Series with O-Ring 90° Elbow ISO 12151-2-SWE-S – DKOS 90°</p>	<p>D2 Dc-4</p>  <p>Male Metric 24° – Rigid Heavy Series – Straight ISO 12151-2-S-S – CES</p>	

BSP

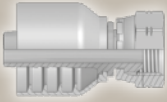
Page Dc-5 – Dc-6

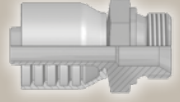
<p>92 Dc-5</p>  <p>Female BSP Parallel Pipe Swivel – Straight (60° Cone) BS5200-A – DKR</p>	<p>B1 Dc-5</p>  <p>Female BSP Parallel Pipe Swivel 45° Elbow (60° Cone) BS 5200-D – DKR 45°</p>	<p>B2 Dc-6</p>  <p>Female BSP Parallel Pipe Swivel 90° Elbow (60° Cone) BS 5200-B – DKR 90°</p>	<p>D9 Dc-6</p>  <p>Male BSP Parallel Pipe Rigid – Straight (60° Cone) BS5200 – AGR</p>
--	--	---	---

SAE

Page Dc-6 – Dc-8

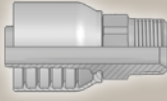
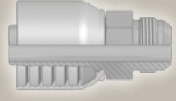
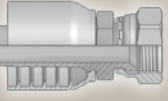
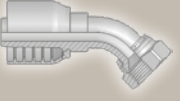
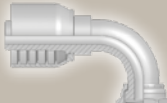
<p>01 Dc-7</p>  <p>Male NPTF Pipe Rigid – Straight SAE J476A / J516 – AGN</p>	<p>03 Dc-7</p>  <p>Male JIC 37° – Rigid Straight ISO12151-5-S – AGJ</p>	<p>06 Dc-8</p>  <p>Female JIC 37° – Swivel Straight ISO12151-5-SWS – DKJ</p>	<p>37 Dc-8</p>  <p>Female JIC 37° – Swivel 45° Elbow ISO 12151-5-SWE 45° – DKJ 45°</p>
<p>39 Dc-9</p>  <p>Female JIC 37° – Swivel 90° Elbow ISO 12151-5-SWES – DKJ 90°</p>			

Flange

Page Dc-10 – Dc-15

<p>15/4A Dc-10 ISO 6162-1-Flange Straight ISO 12151-3-S-L – SFL (35.0 MPa/ 5000 psi)</p> 	<p>17/4F Dc-10 ISO 6162-1-Flange 45° Elbow ISO 12151-3 – E45S – L – SFL 45° (35.0 MPa/ 5000 psi)</p> 	<p>19/4N Dc-11 ISO 6162-1-Flange 90° Elbow ISO 12151-3-E-L – SFL 90° (35.0 MPa/ 5000 psi)</p> 	<p>6A Dc-11 ISO 6162-2-Flange Straight ISO 12151-3-S-S – SFS (42.0 MPa/ 6000 psi)</p> 
<p>6E Dc-12 ISO 6162-2 Flange 30° Elbow SFS 30° (42.0 MPa/ 6000 psi)</p> 	<p>6F Dc-12 ISO 6162-2-Flange 45° Elbow – Heavy Series ISO 12151-3 – E45-S – SFS 45° (42.0 MPa/ 6000 psi)</p> 	<p>6N Dc-13 ISO 6162-2-Flange 90° Elbow ISO 12151-3 – E-S – SFS 90° (42.0 MPa/ 6000 psi)</p> 	<p>XA Dc-13 Caterpillar® Flange Straight</p> 
<p>XF Dc-14 Caterpillar® Flange 45° Elbow</p> 	<p>XG Dc-14 Caterpillar® Flange 60° Elbow</p> 	<p>XN Dc-15 Caterpillar® Flange 90° Elbow</p> 	

ORFS

Page Dc-16 – Dc-18

<p>JC Dc-16 Female ORFS Swivel – Straight Short ISO 12151-1 – SWSA SAE J516 – ORFS</p> 	<p>JS Dc-16 ORFS Swivel Female (Long) ISO 12151-1-SWSB SAE J516 – ORFS</p> 	<p>J7 Dc-17 Female ORFS – Swivel 45° Elbow ISO 12151-1 – SWE 45° SAE J516 – ORFS 45°</p> 	<p>J9 Dc-17 Female ORFS – Swivel 90° Elbow – Short Drop ISO 12151-1 – SWES SAE J516 – ORFS 90°</p> 
<p>JM Dc-18 ORFS Male ISO 12151-1-S – SAE J516</p> 			

Others

Page Dc-19

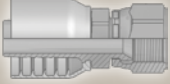
<p>XU Dc-19 Female Metric – Swivel Straight (30° Flare) JIS B8363</p> 
--

**A large range of special hose fittings
for the MRO market can be found
on page Dc-20**

CA Female Metric 24° Light Series with O-Ring Swivel – Straight

ISO 12151-2-SWS-L – DKOL

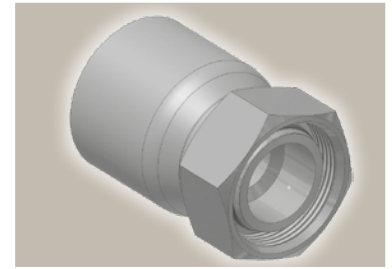
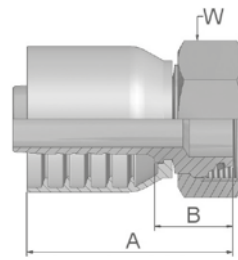

Part Number	Hose I.D.				Thread metric	Tube O.D. mm	A mm	B mm	W mm
	DN	Inch	Size	mm					
1CA73-28-16	25	1	-16	25.4	M36x2	28	87	36	41
1CA73-35-20	31	1 1/4	-20	31.8	M45x2	35	103	39	50
1CA73-42-24	38	1 1/2	-24	38.1	M52x2	42	104	41	60

Fittings with standard O-ring seals can be used for temperatures from -40 °C up to +105 °C.
O-rings see section Eb. Special O-rings are available on request.

CE Female Metric 24° Light Series with O-Ring Swivel – 45° Elbow

ISO 12151-2-SWE -L – DKOL 45°

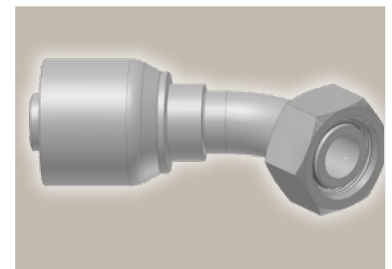
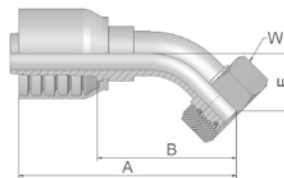

Part Number	Hose I.D.				Thread metric	Tube O.D. mm	A mm	B mm	W mm	
	DN	Inch	Size	mm						
1CE73-35-20	31	1 1/4	-20	31.8	M45x2	35	162	97	37	50

Fittings with standard O-ring seals can be used for temperatures from -40 °C up to +105 °C.
O-rings see section Eb. Special O-rings are available on request.

Approved **fitting series** for hose types:

73 731 731TC SX35 SX35LT SX35TC SX42 SX42LT SX42TC

CF Female Metric 24° Light Series with O-Ring Swivel – 90° Elbow

ISO 12151-2-SWE-L – DKOL 90°

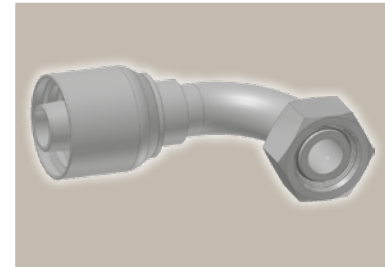
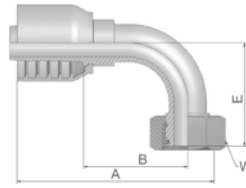

Bestell-Nr.	Schlauch ID				Gewinde metrisch	Rohr AD mm	A mm	B mm	E mm	W mm
	DN	Zoll	Size	mm						
1CF73-28-16	25	1	-16	25.4	-	-	-	-	-	-
1CF73-35-20	31	1 1/4	-20	31.8	M45x2	35	150	86	79	50
1CF73-42-24	38	1 1/2	-24	38.1	-	-	-	-	-	-

Fittings with standard O-ring seals can be used for temperatures from -40 °C up to +105 °C.
O-rings see section Eb. Special O-rings are available on request.

C9 Female Metric 24° – Swivel Heavy Series with O-Ring Straight

ISO 12151-2-SWS-S – DKOS

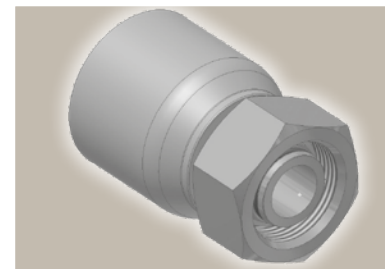
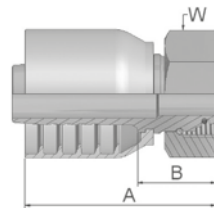

Part Number	Hose I.D.				Thread metric	Tube O.D. mm	A mm	B mm	W mm
	DN	Inch	Size	mm					
1C973-20-12	19	3/4	-12	19.1	M30x2	20	81	33	36
1C973-25-12	19	3/4	-12	19.1	M36x2	25	79	31	46
1C973-25-12SW41	19	3/4	-12	19.1	M36x2	25	79	31	41
1C973-30-12	19	3/4	-12	19.1	M42x2	30	82	34	50
1C973-25-16	25	1	-16	25.4	M36x2	25	87	36	46
1C973-30-16	25	1	-16	25.4	M42x2	30	87	36	50
1C973-25-20	31	1 1/4	-20	31.8	M36x2	25	102	38	46
1C973-30-20	31	1 1/4	-20	31.8	M42x2	30	106	42	50
1C973-38-20	31	1 1/4	-20	31.8	M52x2	38	101	37	60
1C973-38-24	38	1 1/2	-24	38.1	M52x2	38	105	42	60

Fittings with standard O-ring seals can be used for temperatures from -40 °C up to +105 °C.
O-rings see section Eb. Special O-rings are available on request.

Approved **fitting series** for hose types:

73 731 731TC SX35 SX35LT SX35TC SX42 SX42LT SX42TC

0C Female Metric 24° – Swivel Heavy Series with O-Ring 45° Elbow

ISO 12151-2 – SWE -S – DKOS 45°

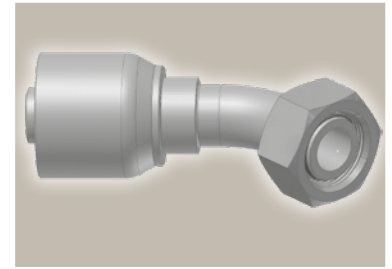
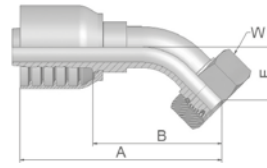

Part Number	Hose I.D.				Thread metric	Tube O.D. mm	A mm	B mm	E mm	W mm
	DN	Inch	Size	mm						
10C73-20-12	19	3/4	-12	19.1	M30x2	20	113	65	30	36
10C73-25-12	19	3/4	-12	19.1	M36x2	25	112	64	29	46
10C73-25-12SW41	19	3/4	-12	19.1	M36x2	25	112	64	29	41
10C73-25-16	25	1	-16	25.4	M36x2	25	128	78	33	46
10C73-30-16	25	1	-16	25.4	M42x2	30	137	128	33	50
10C73-25-20	31	1 1/4	-20	31.8	M36x2	25	150	86	33	46
10C73-30-20	31	1 1/4	-20	31.8	M42x2	30	155	91	34	50
10C73-38-20	31	1 1/4	-20	31.8	M52x2	38	161	97	37	60
10C73-38-24	38	1 1/2	-24	38.1	M52x2	38	182	120	49	60

Fittings with standard O-ring seals can be used for temperatures from -40 °C up to +105 °C.
O-rings see section Eb. Special O-rings are available on request.

1C Female Metric 24° – Swivel Heavy Series with O-Ring 90° Elbow

ISO 12151-2-SWE-S – DKOS 90°

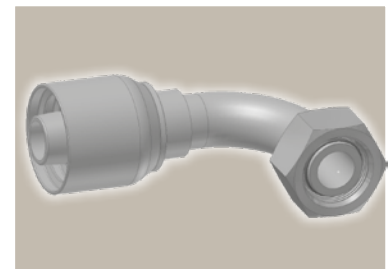
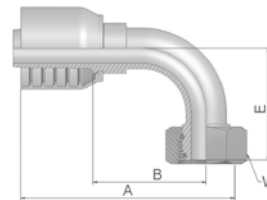

Part Number	Hose I.D.				Thread metric	Tube O.D. mm	A mm	B mm	E mm	W mm
	DN	Inch	Size	mm						
11C73-20-12	19	3/4	-12	19.1	M30x2	20	101	53	60	36
11C73-25-12	19	3/4	-12	19.1	M36x2	25	101	53	59	46
11C73-25-12SW41	19	3/4	-12	19.1	M36x2	25	101	53	59	41
11C73-25-16	25	1	-16	25.4	M36x2	25	117	67	69	46
11C73-30-16	25	1	-16	25.4	M42x2	30	118	67	69	50
11C73-30-20	31	1 1/4	-20	31.8	M42x2	30	137	73	73	50
11C73-38-20	31	1 1/4	-20	31.8	M52x2	38	151	87	78	60
11C73-38-24	38	1 1/2	-24	38.1	M52x2	38	166	103	101	60
11C73-38-32	51	2	-32	50.8	M52x2	38	224	152	166	60

Fittings with standard O-ring seals can be used for temperatures from -40 °C up to +105 °C.
O-rings see section Eb. Special O-rings are available on request.

Approved **fitting series** for hose types:

73 731 731TC SX35 SX35LT SX35TC SX42 SX42LT SX42TC

D2 **Male Metric 24° – Rigid
Heavy Series – Straight**
ISO 12151-2-S-S – CES

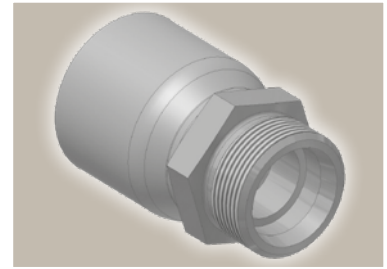
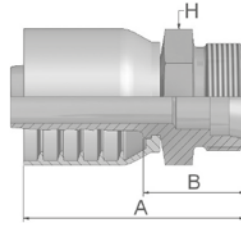

Part Number	Hose I.D.				Thread metric	Tube O.D. mm	A mm	B mm	H mm
	DN	Inch	Size	mm					
1D273-20-12	19	3/4	-12	19.1	M30x2	20	84	35	30
1D273-25-12	19	3/4	-12	19.1	M36x2	25	86	38	36
1D273-30-12	19	3/4	-12	19.1	M42x2	30	90	42	46
1D273-25-16	25	1	-16	25.4	M36x2	25	91	40	36
1D273-30-16	25	1	-16	25.4	M42x2	30	94	42	46
1D273-30-20	31	1 1/4	-20	31.8	M42x2	30	110	46	46
1D273-38-20	31	1 1/4	-20	31.8	M52x2	38	112	46	55

Approved **fitting series** for hose types:

73 731 731TC SX35 SX35LT SX35TC SX42 SX42LT SX42TC

92 Female BSP Parallel Pipe Swivel – Straight (60° Cone)

BS5200-A – DKR

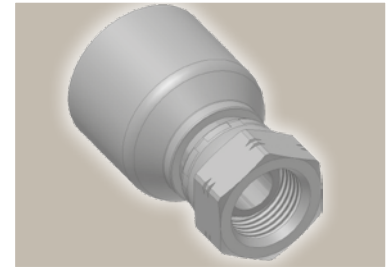
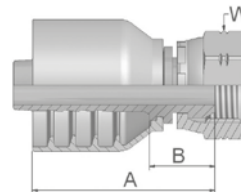

Part Number	Hose I.D.				Thread BSP	A mm	B mm	W mm
	DN	Inch	Size	mm				
19273-12-12	19	3/4	-12	19.1	3/4x14	75	27	32
19273-16-16	25	1	-16	25.4	1x11	89	38	41
19273-20-20	31	1 1/4	-20	31.8	1 1/4x11	101	37	50
19273-24-20	31	1 1/4	-20	31.8	1 1/2x11	101	37	55
19273-24-24	38	1 1/2	-24	38.1	1 1/2x11	100	37	55
19273-32-32	51	2	-32	50.8	2x11	113	38	70

B1 Female BSP Parallel Pipe Swivel 45° Elbow (60° Cone)

BS 5200-D – DKR 45°

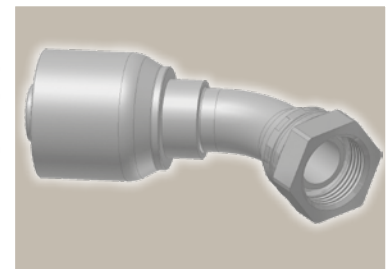
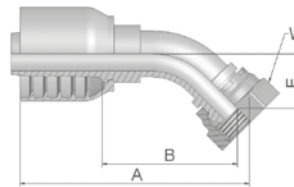

Part Number	Hose I.D.				Thread BSP	A mm	B mm	E mm	W mm
	DN	Inch	Size	mm					
1B173-12-12	19	3/4	-12	19.1	3/4x14	110	62	26	32
1B173-16-16	25	1	-16	25.4	1x11	136	84	36	41
1B173-20-20	31	1 1/4	-20	31.8	1 1/4x11	168	104	43	50
1B173-24-24	38	1 1/2	-24	38.1	1 1/2x11	186	123	52	55
1B173-32-32	51	2	-32	50.8	2x11	249	177	70	70

Approved **fitting series** for hose types:

73 731 731TC SX35 SX35LT SX35TC SX42 SX42LT SX42TC

B2 Female BSP Parallel Pipe Swivel 90° Elbow (60° Cone)

BS 5200-B – DKR 90°

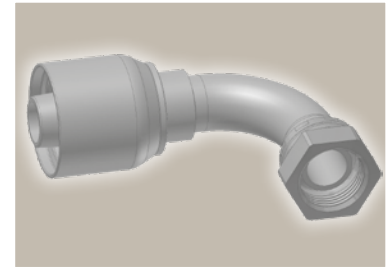
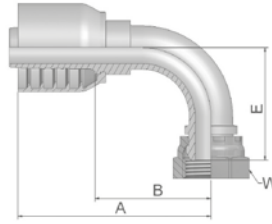

Part Number	Hose I.D.				Thread BSP	A mm	B mm	E mm	W mm
	DN	Inch	Size	mm					
1B273-12-12	19	3/4	-12	19.1	3/4x14	106	58	55	32
1B273-16-16	25	1	-16	25.4	1x11	120	70	74	41
1B273-20-20	31	1 1/4	-20	31.8	1 1/4x11	151	87	80	50
1B273-24-20	31	1 1/4	-20	31.8	1 1/2x11	151	87	80	55
1B273-24-24	38	1 1/2	-24	38.1	1 1/2x11	166	103	103	55
1B273-32-32	51	2	-32	50.8	2x11	229	157	121	70

D9 Male BSP Parallel Pipe Rigid – Straight (60° Cone)

BS5200 – AGR

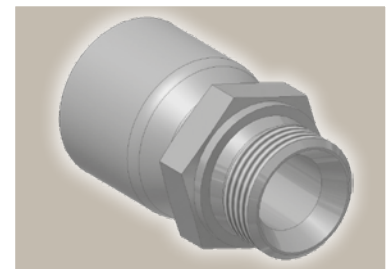
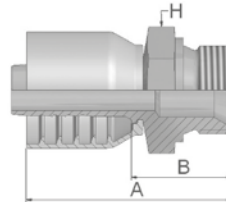

Part Number	Hose I.D.				Thread BSP	A mm	B mm	H mm
	DN	Inch	Size	mm				
1D973-12-12	19	3/4	-12	19.1	3/4x14	87	39	32
1D973-16-16	25	1	-16	25.4	1x11	96	43	41
1D973-20-20	31	1 1/4	-20	31.8	1 1/4x11	113	49	50
1D973-24-24	38	1 1/2	-24	38.1	1 1/2x11	114	51	55
1D973-32-32	51	2	-32	50.8	2x11	129	58	70

Approved **fitting series** for hose types:

73 731 731TC SX35 SX35LT SX35TC SX42 SX42LT SX42TC

01

Male NPTF Pipe Rigid – Straight

SAE J476A / J516 – AGN

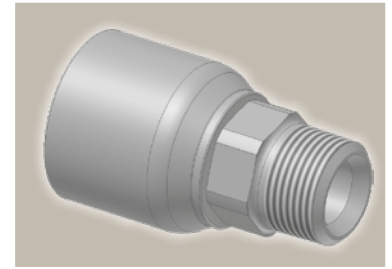
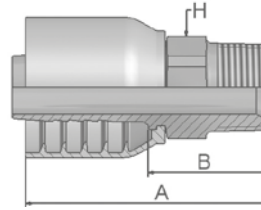

Part Number	Hose I.D.				Thread NPTF	A mm	B mm	H	
	DN	Inch	Size	mm				mm	Inch
10173-12-12-SM	19	3/4	-12	19.1	3/4-14	90	42	30	
10173-16-12-SM	19	3/4	-12	19.1	1-11 1/2	96	48	36	
10173-16-16-SM	25	1	-16	25.4	1-11 1/2	100	50	36	
10173-20-20-SM	31	1 1/4	-20	31.8	1 1/4-11 1/2	125	61	46	
10173-24-24-SM	38	1 1/2	-24	38.1	1 1/2-11 1/2	124	62	50	
10173-32-32	51	2	-32	50.8	2-11 1/2	141	73	2 1/2	

03

Male JIC 37° – Rigid Straight

ISO12151-5-S – AGJ

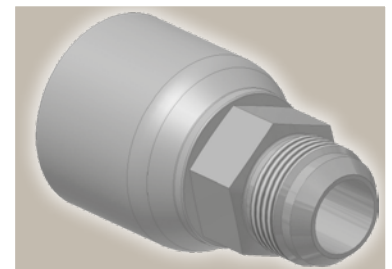
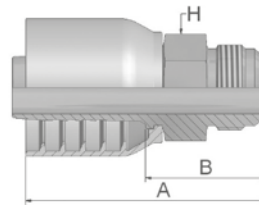

Part Number	Hose I.D.				Thread UNF	A mm	B mm	H	
	DN	Inch	Size	mm				mm	mm
10373-12-12-SM	19	3/4	-12	19.1	1 1/16x12	89	41	30	
10373-16-12-SM	19	3/4	-12	19.1	1 5/16x12	93	45	36	
10373-16-16-SM	25	1	-16	25.4	1 5/16x12	97	47	36	
10373-20-16-SM	25	1	-16	25.4	1 5/8x12	102	52	46	
10373-20-20-SM	31	1 1/4	-20	31.8	1 5/8x12	118	54	46	
10373-24-20-SM	31	1 1/4	-20	31.8	1 7/8x12	118	54	50	
10373-24-24-SM	38	1 1/2	-24	38.1	1 7/8x12	122	59	50	
10373-32-32-SM	51	2	-32	50.8	2 1/2x12	143	72	65	

Approved **fitting series** for hose types:

73 731 731TC SX35 SX35LT SX35TC SX42 SX42LT SX42TC

06 Female JIC 37° – Swivel Straight

ISO12151-5-SWS – DKJ

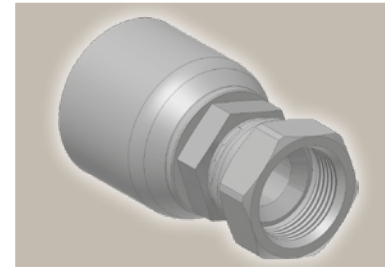
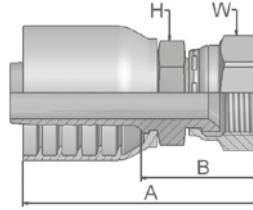

Part Number	Hose I.D.				Thread UNF	A mm	B mm	H		W	
	DN	Inch	Size	mm				mm	Inch	mm	Inch
10673-12-12-SM	19	3/4	-12	19.1	1 1/16x12	93	45	30		32	
10673-16-12	19	3/4	-12	19.1	1 5/16x12	99	51	36		41	
10673-16-16-SM	25	1	-16	25.4	1 5/16x12	103	52	36		41	
10673-20-16	25	1	-16	25.4	1 5/16x12	109	59	41		50	
10673-16-20-SM	31	1 1/4	-20	31.8	1 5/16x12	116	52	46		41	
10673-20-20-SM	31	1 1/4	-20	31.8	1 5/8x12	125	61	46		50	
10673-24-20-SM	31	1 1/4	-20	31.8	1 7/8x12	130	66	50		60	
10673-24-24-SM	38	1 1/2	-24	38.1	1 7/8x12	128	66	50		60	
10673-32-24-SM	38	1 1/2	-24	38.1	2 1/2x12	138	76	65		75	
10673-32-32-SM	51	2	-32	50.8	2 1/2x12	150	79	65		75	

37 Female JIC 37° – Swivel 45° Elbow

ISO 12151-5-SWE 45° – DKJ 45°

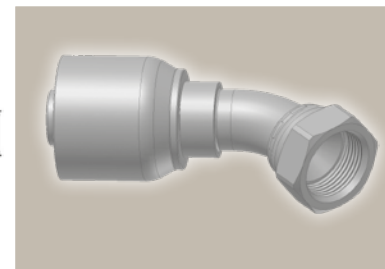
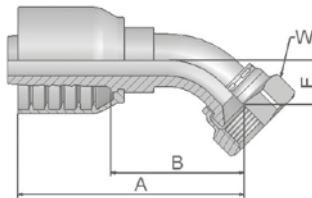

Part Number	Hose I.D.				Thread UNF	A mm	B mm	E mm	W mm
	DN	Inch	Size	mm					
13773-12-12-SM	19	3/4	-12	19.1	1 1/16x12	104	56	22	32
13773-16-12-SM	19	3/4	-12	19.1	1 5/16x12	107	59	24	41
13773-16-16-SM	25	1	-16	25.4	1 5/16x12	119	69	24	41
13773-20-16-SM	25	1	-16	25.4	1 5/8x12	143	92	47	55
13773-20-20-SM	31	1 1/4	-20	31.8	1 5/8x12	171	107	47	50
13773-24-20-SM	31	1 1/4	-20	31.8	1 7/8x12	172	108	48	60
13773-24-24-SM	38	1 1/2	-24	38.1	1 7/8x12	194	132	58	60
13773-32-24-SM	38	1 1/2	-24	38.1	2 1/2x12	208	145	72	75
13773-32-32-SM	51	2	-32	50.8	2 1/2x12	251	179	72	75

Approved **fitting series** for hose types:

73 731 731TC SX35 SX35LT SX35TC SX42 SX42LT SX42TC

39 Female JIC 37° – Swivel 90° Elbow

ISO 12151-5-SWES – DKJ 90°

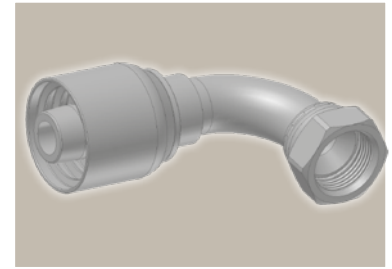
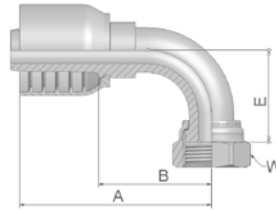

Part Number	Hose I.D.				Thread UNF	A mm	B mm	E mm	W mm
	DN	Inch	Size	mm					
13973-12-12-SM	19	3/4	-12	19.1	1 1/16x12	101	53	48	32
13973-16-12-SM	19	3/4	-12	19.1	1 5/16x12	101	53	56	41
13973-16-16-SM	25	1	-16	25.4	1 5/16x12	118	67	56	41
13973-20-16-SM	25	1	-16	25.4	1 5/8x12	118	67	85	55
13973-20-20-SM	31	1 1/4	-20	31.8	1 5/8x12	150	87	85	50
13973-24-20-SM	31	1 1/4	-20	31.8	1 7/8x12	151	87	102	60
13973-24-24-SM	38	1 1/2	-24	38.1	1 7/8x12	194	119	102	60
13973-32-24-SM	38	1 1/2	-24	38.1	2 1/2x12	168	106	152	75
13973-32-32-SM	51	2	-32	50.8	2 1/2x12	229	157	152	75

Approved **fitting series** for hose types:

- 73 731 731TC SX35 SX35LT SX35TC SX42 SX42LT SX42TC

15/4A ISO 6162-1-Flange Straight

ISO 12151-3-S-L – SFL
(35.0 MPa/ 5000 psi)

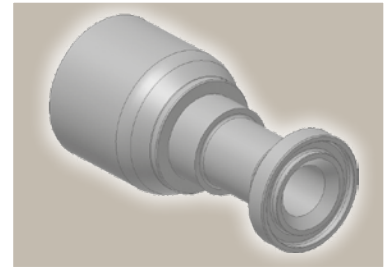
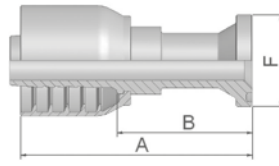

Part Number	Hose I.D.				Flange Inch	A mm	B mm	F mm
	DN	Inch	Size	mm				
11573-12-12	19	3/4	-12	19.1	3/4	110	62	38
11573-16-12	19	3/4	-12	19.1	1	110	62	45
11573-12-16	25	1	-16	25.4	3/4	117	67	38
11573-16-16	25	1	-16	25.4	1	117	67	45
14A73-20-16	25	1	-16	25.4	1 1/4	85	34	51
11573-16-20	31	1 1/4	-20	31.8	1	133	69	45
14A73-20-20	31	1 1/4	-20	31.8	1 1/4	141	77	51
14A73-24-20	31	1 1/4	-20	31.8	1 1/2	104	40	60
14A73-20-24	38	1 1/2	-24	38.1	1 1/4	142	80	51
14A73-24-24	38	1 1/2	-24	38.1	1 1/2	166	103	60
14A73-32-24	38	1 1/2	-24	38.1	2	113	50	71
14A73-24-32	51	2	-32	50.8	1 1/2	156	84	60
14A73-32-32	51	2	-32	50.8	2	220	148	71

SAE flange halves see in section Eb.

Fittings with standard O-ring seals can be used for temperatures from -40 °C up to +105 °C.
O-rings see section Eb. Special O-rings are available on request.

17/4F ISO 6162-1-Flange 45° Elbow

ISO 12151-3 – E45S – L – SFL 45°
(35.0 MPa/ 5000 psi)

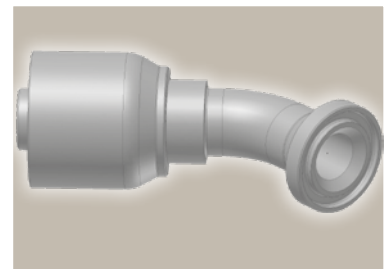
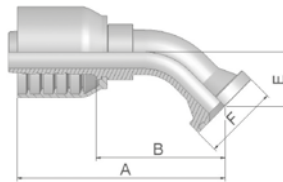

Part Number	Hose I.D.				Flange Inch	A mm	B mm	E mm	F mm
	DN	Inch	Size	mm					
11773-12-12	19	3/4	-12	19.1	3/4	119	71	27	38
11773-16-12	19	3/4	-12	19.1	1	109	64	26	44
11773-12-16	25	1	-16	25.4	3/4	130	80	32	38
11773-16-16	25	1	-16	25.4	1	127	77	32	45
14F73-20-16	25	1	-16	25.4	1 1/4	136	85	32	51
14F73-20-20	31	1 1/4	-20	31.8	1 1/4	160	96	35	51
14F73-24-20	31	1 1/4	-20	31.8	1 1/2	162	102	38	60
14F73-24-24	38	1 1/2	-24	38.1	1 1/2	178	115	44	60
14F73-32-24	38	1 1/2	-24	38.1	2	177	114	43	71
14F73-24-32	51	2	-32	50.8	1 1/2	192	120	53	60
14F73-32-32	51	2	-32	50.8	2	224	153	62	71

SAE flange halves see in section Eb.

Fittings with standard O-ring seals can be used for temperatures from -40 °C up to +105 °C.
O-rings see section Eb. Special O-rings are available on request.

Approved **fitting series** for hose types:

73 731 731TC SX35 SX35LT SX35TC SX42 SX42LT SX42TC

19/4N ISO 6162-1-Flange 90° Elbow

ISO 12151-3-E-L – SFL 90°
(35.0 MPa/ 5000 psi)

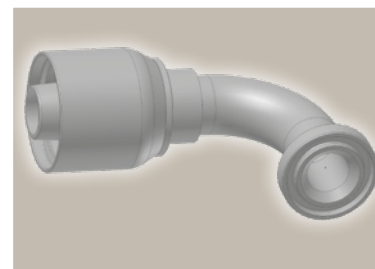
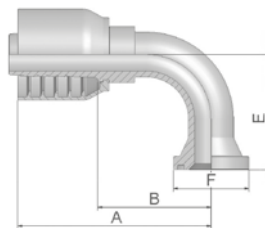

Part Number	Hose I.D.				Flange Inch	A mm	B mm	E mm	F mm
	DN	Inch	Size	mm					
11973-12-12	19	3/4	-12	19.1	3/4	109	61	58	38
11973-16-12	19	3/4	-12	19.1	1	102	54	58	45
11973-12-16	25	1	-16	25.4	3/4	121	70	70	38
11973-16-16	25	1	-16	25.4	1	118	67	70	45
14N73-20-16	25	1	-16	25.4	1 1/4	128	78	68	51
14N73-24-16	25	1	-16	25.4	1 1/2	132	81	70	60
11973-16-20	31	1 1/4	-20	31.8	1	133	69	70	44
14N73-20-20	31	1 1/4	-20	31.8	1 1/4	155	91	90	51
14N73-24-20	31	1 1/4	-20	31.8	1 1/2	155	91	90	60
14N73-24-24	38	1 1/2	-24	38.1	1 1/2	166	103	93	60
14N73-32-24	38	1 1/2	-24	38.1	2	166	103	92	71
14N73-32-32	51	2	-32	50.8	2	220	148	133	71

SAE flange halves see in section Eb.

Fittings with standard O-ring seals can be used for temperatures from -40 °C up to +105 °C.
O-rings see section Eb. Special O-rings are available on request.

6A ISO 6162-2-Flange Straight

ISO 12151-3-S-S – SFS
(42.0 MPa/ 6000 psi)

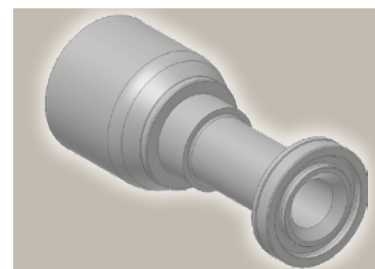
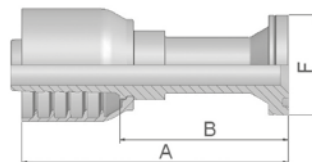

Part Number	Hose I.D.				Flange Inch	A mm	B mm	F mm
	DN	Inch	Size	mm				
16A73-8-12	19	3/4	-12	19.1	1/2	123	75	32
16A73-12-12	19	3/4	-12	19.1	3/4	130	82	41
16A73-16-12	19	3/4	-12	19.1	1	135	87	48
16A73-20-12	19	3/4	-12	19.1	1 1/4	96	48	54
16A73-12-16	25	1	-16	25.4	3/4	124	73	41
16A73-16-16	25	1	-16	25.4	1	131	81	48
16A73-20-16	25	1	-16	25.4	1 1/4	142	91	54
16A73-16-20	31	1 1/4	-20	31.8	1	147	83	48
16A73-20-20	31	1 1/4	-20	31.8	1 1/4	149	85	54
16A73-24-20	31	1 1/4	-20	31.8	1 1/2	121	57	64
16A73-20-24	38	1 1/2	-24	38.1	1 1/4	158	96	54
16A73-24-24	38	1 1/2	-24	38.1	1 1/2	166	104	64
16A73-32-24	38	1 1/2	-24	38.1	2	129	66	79
16A73-32-32	51	2	-32	50.8	2	194	122	79

SAE flange halves see in section Eb.

Fittings with standard O-ring seals can be used for temperatures from -40 °C up to +105 °C.
O-rings see section Eb. Special O-rings are available on request.

Approved **fitting series** for hose types:

73 731 731TC SX35 SX35LT SX35TC SX42 SX42LT SX42TC

6E **ISO 6162-2 Flange**
30° Elbow
SFS 30°
(42.0 MPa/ 6000 psi)

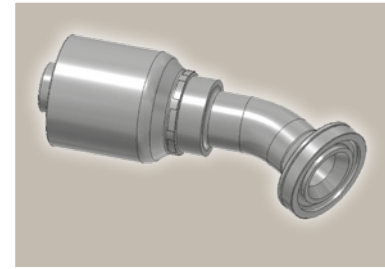
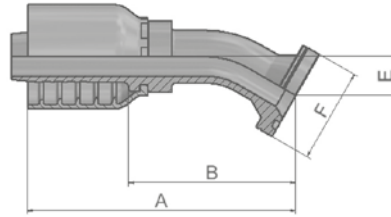

Part Number	Hose I.D.				Flange Inch	A mm	B mm	E mm	F mm
	DN	Inch	Size	mm					
16E73-12-12	19	3/4	-12	19.1	-	-	-	-	-
16E73-12-16	25	1	-16	25.4	-	-	-	-	-
16E73-16-16	25	1	-16	25.4	-	-	-	-	-

SAE flange halves see in section Eb.

Fittings with standard O-ring seals can be used for temperatures from -40 °C up to +105 °C.
O-rings see section Eb. Special O-rings are available on request.

6F **ISO 6162-2-Flange**
45° Elbow – Heavy Series
ISO 12151-3 – E45-S – SFS 45°
(42.0 MPa/ 6000 psi)

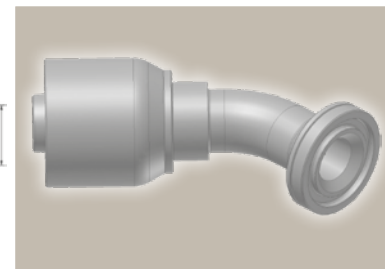
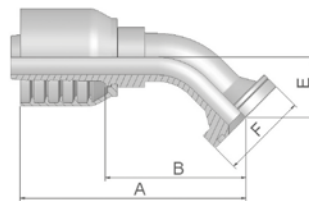

Part Number	Hose I.D.				Flange Inch	A mm	B mm	E mm	F mm
	DN	Inch	Size	mm					
16F73-8-12	19	3/4	-12	19.1	1/2	107	59	27	32
16F73-12-12	19	3/4	-12	19.1	3/4	110	62	26	41
16F73-16-12	19	3/4	-12	19.1	1	110	62	26	48
16F73-20-12	19	3/4	-12	19.1	1 1/4	125	77	32	54
16F73-12-16	25	1	-16	25.4	3/4	123	73	32	41
16F73-16-16	25	1	-16	25.4	1	129	79	32	48
16F73-20-16	25	1	-16	25.4	1 1/4	129	79	32	54
16F73-16-20	31	1 1/4	-20	31.8	1	157	93	33	48
16F73-20-20	31	1 1/4	-20	31.8	1 1/4	163	98	38	54
16F73-24-20	31	1 1/4	-20	31.8	1 1/2	163	99	38	63
16F73-20-24	38	1 1/2	-24	38.1	1 1/4	170	107	44	54
16F73-24-24	38	1 1/2	-24	38.1	1 1/2	178	115	44	64
16F73-32-32	51	2	-32	50.8	2	230	158	56	79

SAE flange halves see in section Eb.

Fittings with standard O-ring seals can be used for temperatures from -40 °C up to +105 °C.
O-rings see section Eb. Special O-rings are available on request.

Approved **fitting series** for hose types:

73 731 731TC SX35 SX35LT SX35TC SX42 SX42LT SX42TC

6N ISO 6162-2-Flange 90° Elbow

ISO 12151-3 – E-S – SFS 90°
(42.0 MPa/ 6000 psi)

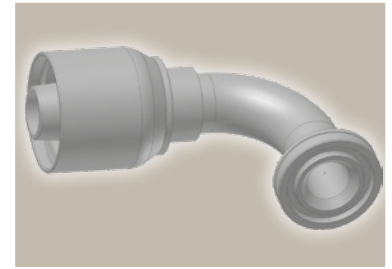
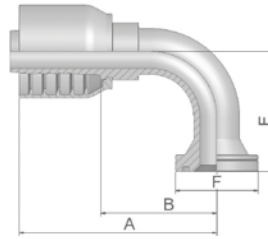

Part Number	Hose I.D.				Flange Inch	A mm	B mm	E mm	F mm
	DN	Inch	Size	mm					
16N73-8-12	19	3/4	-12	19.1	1/2	92	44	58	32
16N73-12-12	19	3/4	-12	19.1	3/4	101	53	58	41
16N73-16-12	19	3/4	-12	19.1	1	111	63	58	48
16N73-20-12	19	3/4	-12	19.1	1 1/4	110	62	63	54
16N73-12-16	25	1	-16	25.4	3/4	109	58	70	41
16N73-16-16	25	1	-16	25.4	1	122	71	70	48
16N73-20-16	25	1	-16	25.4	1 1/4	122	71	70	54
16N73-16-20	31	1 1/4	-20	31.8	1	137	73	90	48
16N73-20-20	31	1 1/4	-20	31.8	1 1/4	172	108	71	54
16N73-24-20	31	1 1/4	-20	31.8	1 1/2	172	108	76	64
16N73-20-24	38	1 1/2	-24	38.1	1 1/4	152	90	104	54
16N73-24-24	38	1 1/2	-24	38.1	1 1/2	166	103	104	64
16N73-32-24	38	1 1/2	-24	38.1	2	166	103	104	79
16N73-24-32	51	2	-32	50.8	1 1/2	188	116	104	64
16N73-32-32	51	2	-32	50.8	2	229	157	138	79

SAE flange halves see in section Eb.

Fittings with standard O-ring seals can be used for temperatures from -40 °C up to +105 °C.
O-rings see section Eb. Special O-rings are available on request.

XA Caterpillar® Flange Straight

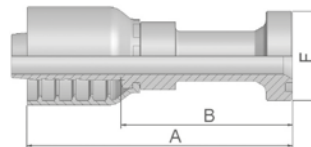

Part Number	Hose I.D.				Flange Inch	A mm	B mm	F mm
	DN	Inch	Size	mm				
1XA73-12-12	19	3/4	-12	19.1	3/4	123	75	41
1XA73-16-12	19	3/4	-12	19.1	1	134	86	48
1XA73-16-16	25	1	-16	25.4	1	138	88	48
1XA73-20-16	25	1	-16	25.4	1 1/4	144	93	54
1XA73-20-20	31	1 1/4	-20	31.8	1 1/4	155	96	54
1XA73-24-20	31	1 1/4	-20	31.8	1 1/2	162	97	64

Fittings with standard O-ring seals can be used for temperatures from -40 °C up to +105 °C.
O-rings see section Eb. Special O-rings are available on request.

Approved **fitting series** for hose types:

73 731 731TC SX35 SX35LT SX35TC SX42 SX42LT SX42TC

XF Caterpillar® Flange 45° Elbow

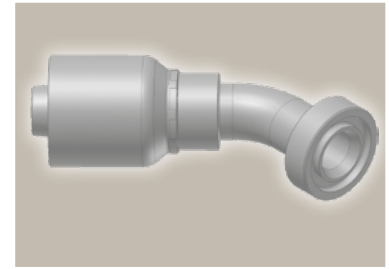
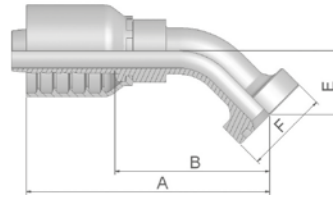

Part Number	Hose I.D.				Flange Inch	A mm	B mm	E mm	F mm
	DN	Inch	Size	mm					
1XF73-12-12	19	3/4	-12	19.1	3/4	123	75	31	41
1XF73-16-12	19	3/4	-12	19.1	1	122	74	31	48
1XF73-16-16	25	1	-16	25.4	1	139	88	36	48
1XF73-20-20	31	1 1/4	-20	31.8	1 1/4	162	98	37	54
1XF73-24-20	31	1 1/4	-20	31.8	1 1/2	182	117	36	64

Fittings with standard O-ring seals can be used for temperatures from -40 °C up to +105 °C.
O-rings see section Eb. Special O-rings are available on request.

XG Caterpillar® Flange 60° Elbow

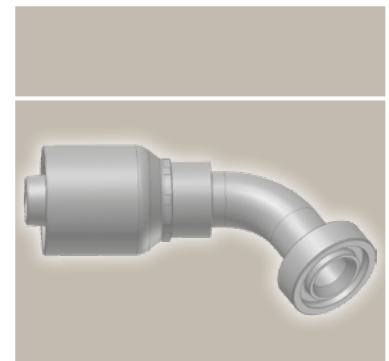
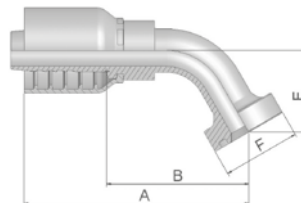

Part Number	Hose I.D.				Flange Inch	A mm	B mm	E mm	F mm
	DN	Inch	Size	mm					
1XG73-12-12	19	3/4	-12	19.1	3/4	41	138	90	42
1XG73-16-16	25	1	-16	25.4	1	48	160	109	50
1XG73-20-16	25	1	-16	25.4	1 1/4	54	153	103	48



Fittings with standard O-ring seals can be used for temperatures from -40 °C up to +105 °C.
O-rings see section Eb. Special O-rings are available on request.

Approved **fitting series** for hose types:

73 731 731TC SX35 SX35LT SX35TC SX42 SX42LT SX42TC

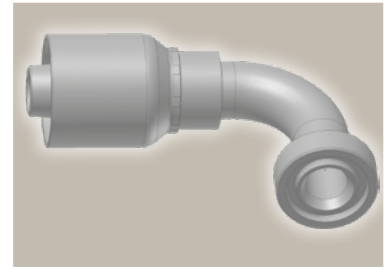
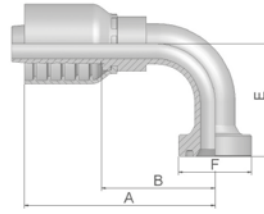
**XN Caterpillar® Flange
90° Elbow**



Part Number	 Hose I.D.				 Flange	A mm	B mm	E mm	F mm
	DN	Inch	Size	mm					
1XN73-12-12	19	3/4	-12	19.1	3/4	111	63	63	41
1XN73-16-12	19	3/4	-12	19.1	1	111	63	62	48
1XN73-16-16	25	1	-16	25.4	1	128	78	74	48
1XN73-20-16	25	1	-16	25.4	1 1/4	122	71	74	54
1XN73-20-20	31	1 1/4	-20	31.8	1 1/4	172	108	77	54

Fittings with standard O-ring seals can be used for temperatures from -40 °C up to +105 °C.
O-rings see section Eb. Special O-rings are available on request.

Approved **fitting series** for hose types:

73	731	731TC	SX35	SX35LT	SX35TC	SX42	SX42LT	SX42TC
-----------	-----	-------	------	--------	--------	------	--------	--------

JC Female ORFS Swivel – Straight Short

ISO 12151-1 – SWSA
SAE J516 – ORFS

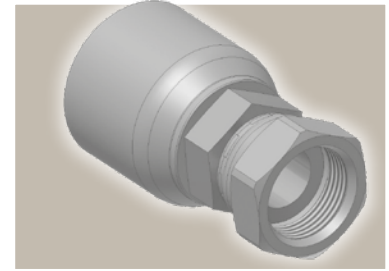
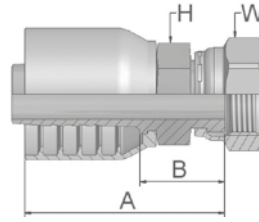

Part Number	Hose I.D.				Thread UNF	A mm	B mm	H mm	W mm
	DN	Inch	Size	mm					
1JC73-12-12-SM	19	3/4	-12	19.1	1 3/16x12	81	33	30	36
1JC73-16-16-SM	25	1	-16	25.4	1 7/16x12	89	38	36	41
1JC73-20-20-SM	31	1 1/4	-20	31.8	1 11/16x12	106	42	46	50
1JC73-24-24-SM	38	1 1/2	-24	38.1	2x12	117	44	50	60

JS ORFS Swivel Female (Long)

ISO 12151-1-SWSB
SAE J516 – ORFS

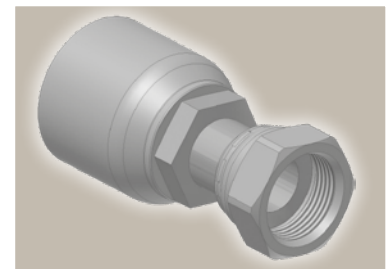
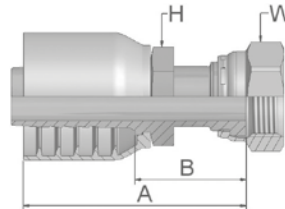

Part Number	Hose I.D.				Thread UNF	A mm	B mm	H		W	
	DN	Inch	Size	mm				mm	Inch	mm	Inch
1JS73-12-12-SM	19	3/4	-12	19.1	1 3/16x12	94	46	30		36	
1JS73-16-12-SM	19	3/4	-12	19.1	1 7/16x12	107	58	36		41	
1JS73-16-16-SM	25	1	-16	25.4	1 7/16x12	103	52	36		41	
1JS73-20-16-SM	25	1	-16	25.4	1 11/16x12	114	64	41		50	
1JS73-20-20-SM	31	1 1/4	-20	31.8	1 11/16x12	117	54	46		50	
1JS73-24-24-SM	38	1 1/2	-24	38.1	2x12	120	57	50		60	

Approved **fitting series** for hose types:

73 731 731TC SX35 SX35LT SX35TC SX42 SX42LT SX42TC

J7 Female ORFS – Swivel 45° Elbow

ISO 12151-1 – SWE 45°
SAE J516 – ORFS 45°

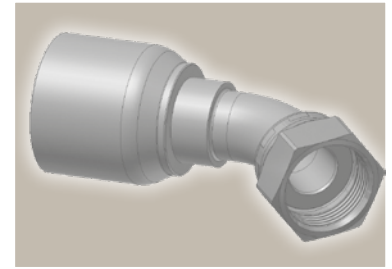
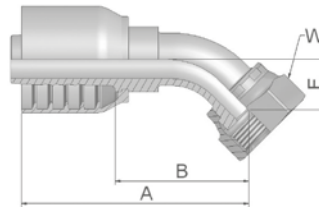

Part Number	Hose I.D.				Thread UNF	A mm	B mm	E mm	W mm
	DN	Inch	Size	mm					
1J773-12-12-SM	19	3/4	-12	19.1	1 3/16x12	105	57	21	36
1J773-16-12-SM	19	3/4	-12	19.1	1 7/16x12	107	59	24	41
1J773-16-16-SM	25	1	-16	25.4	1 7/16x12	119	69	24	41
1J773-20-16-SM	25	1	-16	25.4	1 11/16x12	131	80	26	50
1J773-20-20	31	1 1/4	-20	31.8	1 11/16x12	147	83	25	7/8
1J773-20-20-SM	31	1 1/4	-20	31.8	1 11/16x12	154	90	30	50
1J773-24-20-SM	31	1 1/4	-20	31.8	2x12	164	100	40	60

J9 Female ORFS – Swivel 90° Elbow – Short Drop

ISO 12151-1 – SWES
SAE J516 – ORFS 90°

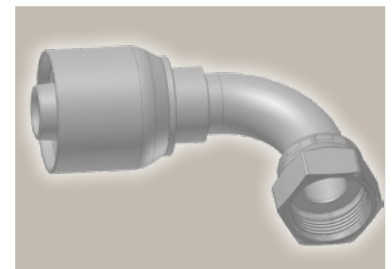
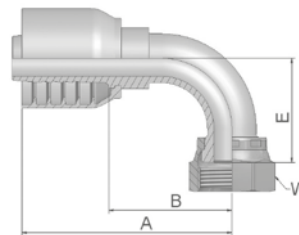

Part Number	Hose I.D.				Thread UNF	A mm	B mm	E mm	W mm Inch
	DN	Inch	Size	mm					
1J973-12-12-SM	19	3/4	-12	19.1	1 3/16x12	101	53	48	36
1J973-16-12-SM	19	3/4	-12	19.1	1 7/16x12	113	65	56	41
1J973-16-16-SM	25	1	-16	25.4	1 7/16x12	120	70	56	41
1J973-20-16-SM	25	1	-16	25.4	1 11/16x12	127	77	64	50
1J973-20-20	31	1 1/4	-20	31.8	1-11/16x12	148	84	64	7/8
1J973-24-24-SM	38	1 1/2	-24	38.1	2x12	166	103	82	60

Approved **fitting series** for hose types:



73 731 731TC SX35 SX35LT SX35TC SX42 SX42LT SX42TC

JM

ORFS Male

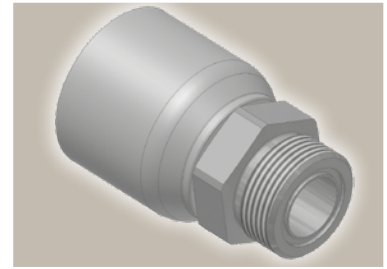
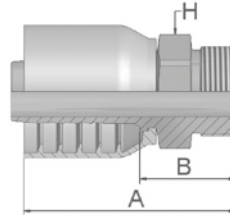
ISO 12151-1-S – SAE J516



Part Number	 Hose I.D.				 Thread UNF	A mm	B mm	 H mm
	DN	Inch	Size	mm				
1JM73-12-12-SM	19	3/4	-12	19.1	1 3/16x12	86	38	32
1JM73-16-12-SM	19	3/4	-12	19.1	1 7/16x12	87	39	41
1JM73-16-16-SM	25	1	-16	25.4	1 7/16x12	93	42	41
1JM73-20-16-SM	25	1	-16	25.4	1 11/16x12	89	39	46
1JM73-20-20-SM	31	1 1/4	-20	31.8	1 11/16x12	106	42	46

JM fittings are supplied without O-ring.

O-rings see section Eb. Special O-rings are available on request.

Approved **fitting series** for hose types:

73 731 731TC SX35 SX35LT SX35TC SX42 SX42LT SX42TC

XU

Female Metric – Swivel Straight (30° Flare)

JIS B8363

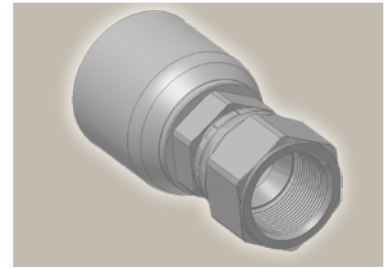
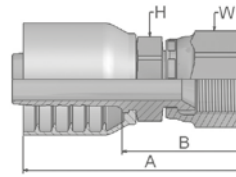

Part Number	Hose I.D.				Thread metric	A mm	B mm	H mm	W mm
	DN	Inch	Size	mm					
1XU73-12-12	19	3/4	-12	19.1	M30x1.5	76	28	32	36
1XU73-16-16	25	1	-16	25.4	M33x1.5	85	35	36	41

Approved **fitting series** for hose types:

73	731	731TC	SX35	SX35LT	SX35TC	SX42	SX42LT	SX42TC
-----------	-----	-------	------	--------	--------	------	--------	--------

Large range of special hose fittings for the MRO market



The demand for special hose fittings is part of our everyday business.

In order to meet this demand with the authority expected, the Hose Products Division Europe has extended its standard offer with special hose fittings such as an extra drop length, etc.

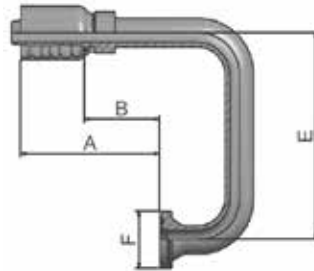
The following is an overview of our special hose fitting selection:



Further special hose fittings are available on request.









Part Number	Description			A mm	B mm	E mm	F mm
		Hose I.D. Size	Flange Inch				
11973-12-12-SL100	SAE 5000 psi 90° elbow - drop length 100 mm	-12	3/4	109	61	100	38
11973-12-12-SL150	SAE 5000 psi 90° elbow - drop length 150 mm	-12	3/4	109	61	150	38
11973-12-12-SL180	SAE 5000 psi 90° elbow - drop length 180 mm	-12	3/4	109	61	180	38
11973-16-16-SL100	SAE 5000 psi 90° elbow - drop length 100 mm	-16	1	118	67	100	45
11973-16-16-SL150	SAE 5000 psi 90° elbow - drop length 150 mm	-16	1	118	67	150	45
11973-16-16-SL90	SAE 5000 psi 90° elbow - drop length 90 mm	-16	1	118	67	90	45
14N73-20-20-SL150	SAE 5000 psi 90° elbow - drop length 150 mm	-20	1 1/4	155	91	150	51
16N73-12-12-SL100	SAE 6000 psi 90° elbow - drop length 100 mm	-12	3/4	101	53	100	41
16N73-12-12-SL140	SAE 6000 psi 90° elbow - drop length 140 mm	-12	3/4	101	53	140	41
16N73-12-12-SL150	SAE 6000 psi 90° elbow - drop length 150 mm	-12	3/4	101	53	150	41
16N73-12-12-SL85	SAE 6000 psi 90° elbow - drop length 85 mm	-12	3/4	101	53	85	41
16N73-16-12-SL100	SAE 6000 psi 90° elbow - drop length 100 mm	-12	1	111	63	100	48
16N73-16-12-SL116	SAE 6000 psi 90° elbow - drop length 116 mm	-12	1	111	63	116	48
16N73-16-12-SL120	SAE 6000 psi 90° elbow - drop length 120 mm	-12	1	111	63	120	48
16N73-16-16-SL100	SAE 6000 psi 90° elbow - drop length 100 mm	-16	1	118	67	100	48
16N73-16-16-SL110	SAE 6000 psi 90° elbow - drop length 110 mm	-16	1	122	71	110	48
16N73-16-16-SL116	SAE 6000 psi 90° elbow - drop length 116 mm	-16	1	128	77	116	48
16N73-16-16-SL125	SAE 6000 psi 90° elbow - drop length 125 mm	-16	1	118	67	125	48
16N73-16-16-SL140	SAE 6000 psi 90° elbow - drop length 140 mm	-16	1	122	71	140	48
16N73-16-16-SL175	SAE 6000 psi 90° elbow - drop length 175 mm	-16	1	122	71	175	48
16N73-16-16SL150	SAE 6000 psi 90° elbow - drop length 150 mm	-16	1	117	67	150	48
16N73-20-16-SL120	SAE 6000 psi 90° elbow - drop length 120 mm	-16	1 1/4	122	71	120	54
16N73-20-16-SL160	SAE 6000 psi 90° elbow - drop length 160 mm	-16	1 1/4	122	71	160	54
16N73-20-20-SL100	SAE 6000 psi 90° elbow - drop length 100 mm	-20	1 1/4	155	91	100	54
16N73-20-20-SL180	SAE 6000 psi 90° elbow - drop length 180 mm	-20	1 1/4	155	91	180	54
16N73-20-20SL145	SAE 6000 psi 90° elbow - drop length 145 mm	-20	1 1/4	155	91	145	54
16N73-24-24-SL90	SAE 6000 psi 90° elbow - drop length 90 mm	-24	1 1/2	166	103	90	64

Approved **fitting series** for hose types:

73 731 731TC SX35 SX35LT SX35TC SX42 SX42LT SX42TC

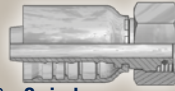

DIN – Metric

Page Dd-1 – Dd-4

<p>CA</p> <p>Dd-1</p>  <p>Female Metric 24° Light Series with O-Ring Swivel – Straight ISO 12151-2-SWS-L – DKOL</p>	<p>CE</p> <p>Dd-1</p>  <p>Female Metric 24° Light Series with O-Ring Swivel – 45° Elbow ISO 12151-2-SWE-L – DKOL 45°</p>	<p>CF</p> <p>Dd-2</p>  <p>Female Metric 24° Light Series with O-Ring Swivel – 90° Elbow ISO 12151-2-SWE-L – DKOL 90°</p>	<p>D0</p> <p>Dd-2</p>  <p>Male Metric 24° Light Series – Rigid Straight ISO 12151-2-S-L – CEL</p>
<p>C9</p> <p>Dd-3</p>  <p>Female Metric 24° – Swivel Heavy Series with O-Ring Straight ISO 12151-2-SWS-S – DKOS</p>	<p>OC</p> <p>Dd-3</p>  <p>Female Metric 24° – Swivel Heavy Series with O-Ring 45° Elbow ISO 12151-2-SWE-S – DKOS 45°</p>	<p>1C</p> <p>Dd-4</p>  <p>Female Metric 24° – Swivel Heavy Series with O-Ring 90° Elbow ISO 12151-2-SWE-S – DKOS 90°</p>	<p>D2</p> <p>Dd-4</p>  <p>Male Metric 24° – Rigid Heavy Series – Straight ISO 12151-2-S-S – CES</p>

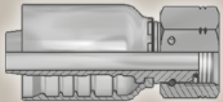
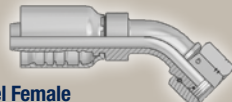
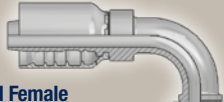

BSP

Page Dd-5 – Dd-6

<p>EA</p> <p>Dd-5</p>  <p>BSP Swivel Female with O-Ring (60° Cone) Straight BS 5200 – ISO 12151-6 – DKOR</p>	<p>EB</p> <p>Dd-5</p>  <p>BSP Swivel Female with O-Ring 45° Elbow (60° Cone) BS 5200 – ISO 12151-6 – DKOR 45°</p>	<p>EC</p> <p>Dd-6</p>  <p>BSP Swivel Female with O-Ring 90° Elbow (60° Cone) BS 5200 – ISO 12151-6 – DKOR 90°</p>	<p>D9</p> <p>Dd-6</p>  <p>Male BSP Parallel Pipe Rigid – Straight (60° Cone) BS5200 – AGR</p>
---	--	---	--

SAE

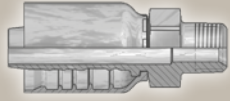
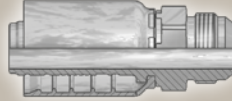
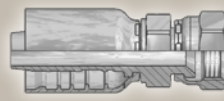
Page Dd-7 – Dd-9

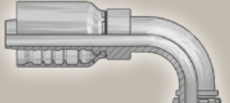
<p>01</p> <p>Dd-7</p>  <p>Male NPTF Pipe Rigid – Straight SAE J476A / J516 – AGN</p>	<p>03</p> <p>Dd-7</p>  <p>Male JIC 37° – Rigid Straight ISO12151-5-S – AGJ</p>	<p>06</p> <p>Dd-8</p>  <p>Female JIC 37° – Swivel Straight ISO12151-5-SWS – DKJ</p>	<p>37</p> <p>Dd-9</p>  <p>Female JIC 37° – Swivel 45° Elbow ISO 12151-5-SWE 45° – DKJ 45°</p>
<p>39</p> <p>Dd-9</p>  <p>Female JIC 37° – Swivel 90° Elbow ISO 12151-5-SWES – DKJ 90°</p>			

Flange

Page Dd-10 – Dd-20

<p>15/4A Dd-10 ISO 6162-1-Flange Straight ISO 12151-3-S-L – SFL (35.0 MPa/ 5000 psi)</p> 	<p>17/4F Dd-11 ISO 6162-1-Flange 45° Elbow ISO 12151-3 – E45S – L – SFL 45° (35.0 MPa/ 5000 psi)</p> 	<p>19/4N Dd-12 ISO 6162-1-Flange 90° Elbow ISO 12151-3-E-L – SFL 90° (35.0 MPa/ 5000 psi)</p> 	<p>6A Dd-13 ISO 6162-2-Flange Straight ISO 12151-3-S-S – SFS (42.0 MPa/ 6000 psi)</p> 
<p>6E Dd-14 ISO 6162-2-Flange 30° Elbow SFS 30° (42.0 MPa/ 6000 psi)</p> 	<p>6F Dd-16 ISO 6162-2-Flange 45° Elbow – Heavy Series ISO 12151-3 – E45-S – SFS 45° (42.0 MPa/ 6000 psi)</p> 	<p>6N Dd-15 ISO 6162-2-Flange 90° Elbow ISO 12151-3 – E-S – SFS 90° (42.0 MPa/ 6000 psi)</p> 	<p>X5 Dd-16 Flange – Straight Full flange system for ISO 6162-1 or ISO 6162-2</p> 
<p>X7 Dd-16 Flange – 45° Elbow Full flange system for ISO 6162-1 or ISO 6162-2</p> 	<p>X9 Dd-17 Flange – 90° Elbow Full flange system for ISO 6162-1 or ISO 6162-2</p> 	<p>XA Dd-17 Caterpillar® Flange Straight</p> 	<p>XF Dd-18 Caterpillar® Flange 45° Elbow</p> 
<p>XG Dd-18 Caterpillar® Flange 60° Elbow</p> 	<p>XN Dd-19 Caterpillar® Flange 90° Elbow</p> 	<p>K5 Dd-19 Komatsu® Flange Straight</p> 	<p>K7 Dd-20 Komatsu® Flange 45° Elbow</p> 
<p>K9 Dd-20 Komatsu® Flange 90° Elbow</p> 			

ORFS

Page Dd-21 – Dd-23

<p>JC Dd-21 Female ORFS Swivel – Straight Short ISO 12151-1 – SWSA SAE J516 – ORFS</p> 	<p>J7 Dd-21 Female ORFS – Swivel 45° Elbow ISO 12151-1 – SWE 45° SAE J516 – ORFS 45°</p> 	<p>J9 Dd-22 Female ORFS – Swivel 90° Elbow – Short Drop ISO 12151-1 – SWES SAE J516 – ORFS 90°</p> 	<p>J1 Dd-22 Female ORFS – Swivel 90° Elbow – Long Drop ISO 12151-1 – SWEL SAE J516 – ORFS 90° L</p> 
<p>JM Dd-23 ORFS Male ISO 12151-1-S – SAE J516</p> 			

**A large range of special hose fittings
for the MRO market can be found
on page Dd-25**

French Standard

Page Dd-24

FG
Dd-24
Male French Gas Series
Rigid – Straight (24° Cone)



CA **Female Metric 24°
Light Series with O-Ring
Swivel – Straight**
ISO 12151-2-SWS-L – DKOL

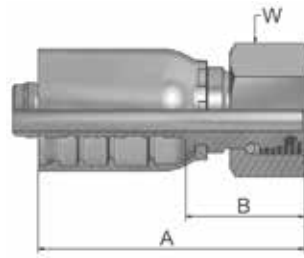

Part Number	Hose I.D.				Thread metric	Tube O.D. mm	A mm	B mm	W mm
	DN	Inch	Size	mm					
1CA77-15-8	12	1/2	-8	12.7	M22x1.5	15	63	28	27
1CA77-18-10	16	5/8	-10	15.9	M26x1.5	18	66	27	32
1CA77-18-12	19	3/4	-12	19.1	-	18	74	28	32
1CA77-22-12	19	3/4	-12	19.1	M30x2	22	73	27	36
1CA77-22-16	25	1	-16	25.4	M30x2	22	88	33	36
1CA77-28-16	25	1	-16	25.4	M36x2	28	89	35	41
1CA77-35-20	31	1 1/4	-20	31.8	M45x2	35	100	37	50
1CA77-42-24	38	1 1/2	-24	38.1	M52x2	42	106	39	60

Fittings with standard O-ring seals can be used for temperatures from -40 °C up to +105 °C.
O-rings see section Eb. Special O-rings are available on request.

CE **Female Metric 24°
Light Series with O-Ring
Swivel – 45° Elbow**
ISO 12151-2-SWE -L – DKOL 45°

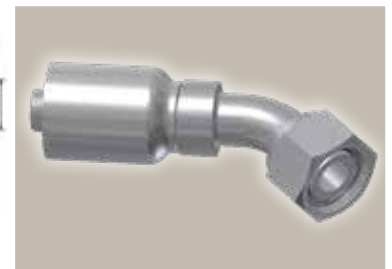
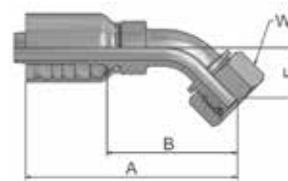

Part Number	Hose I.D.				Thread metric	Tube O.D. mm	A mm	B mm	E mm	W mm
	DN	Inch	Size	mm						
1CE77-15-8	12	1/2	-8	12.7	M22x1.5	15	84	49	24	27
1CE77-22-12	19	3/4	-12	19.1	M30x2	22	120	74	29	36
1CE77-28-16	25	1	-16	25.4	M36x2	28	142	88	33	41
1CE77-35-20	31	1 1/4	-20	31.8	M45x2	35	162	98	37	50
1CE77-42-24	38	1 1/2	-24	38.1	M52x2	42	201	134	49	60

Fittings with standard O-ring seals can be used for temperatures from -40 °C up to +105 °C.
O-rings see section Eb. Special O-rings are available on request.

Approved **fitting series** for hose types, depending on size:

77	387	387ST	387TC	487	487ST	487TC	787	787TC	787ST	797	797TC	797ST	797RH	SX42 ...
	SX42LT	SX42TC												

CF **Female Metric 24°
Light Series with O-Ring
Swivel – 90° Elbow**

ISO 12151-2-SWE-L – DKOL 90°

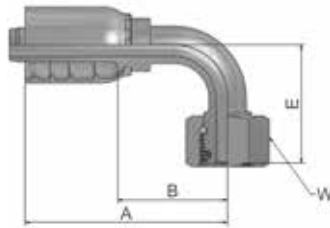

Part Number	Hose I.D.				Thread metric	Tube O.D. mm	A mm	B mm	E mm	W mm
	DN	Inch	Size	mm						
1CF77-15-8	12	1/2	-8	12.7	M22x1.5	15	76	41	45	27
1CF77-18-10	16	5/8	-10	15.9	M26x1.5	18	92	53	49	32
1CF77-18-12	19	3/4	-12	19.1	M26x1.5	18	108	62	56	32
1CF77-22-12	19	3/4	-12	19.1	M30x2	22	108	62	59	36
1CF77-28-16	25	1	-16	25.4	M36x2	28	131	77	69	41
1CF77-35-20	31	1 1/4	-20	31.8	M45x2	35	151	87	79	50
1CF77-42-24	38	1 1/2	-24	38.1	M52x2	42	179	112	101	60

Fittings with standard O-ring seals can be used for temperatures from -40 °C up to +105 °C.
O-rings see section Eb. Special O-rings are available on request.

DO **Male Metric 24°
Light Series – Rigid
Straight**

ISO 12151-2-S-L – CEL

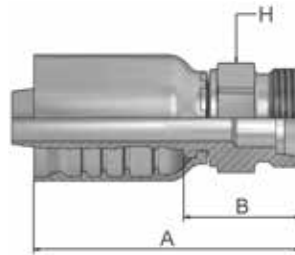

Part Number	Hose I.D.				Thread metric	A mm	B mm	H mm
	DN	Inch	Size	mm				
1D077-15-8	12	1/2	-8	12.7	M22x1.5	61	27	22
1D077-18-10	16	5/8	-10	15.9	M26x1.5	68	30	27
1D077-22-12	19	3/4	-12	19.1	M30x2	82	36	30
1D077-28-16	25	1	-16	25.4	M36x2	92	38	36

Approved **fitting series** for **hose types**, depending on size:

77	387	387ST	387TC	487	487ST	487TC	787	787TC	787ST	797	797TC	797ST	797RH	SX42	...
SX42LT SX42TC															

C9 Female Metric 24° – Swivel Heavy Series with O-Ring Straight

ISO 12151-2-SWS-S – DKOS

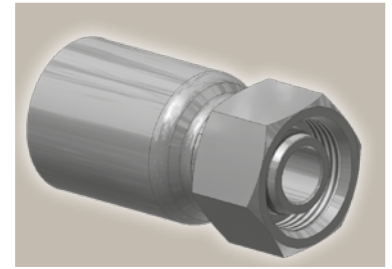
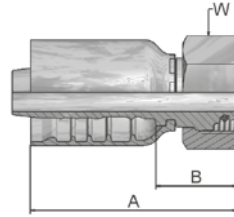

Part Number	Hose I.D.				Thread metric	A mm	B mm	W mm
	DN	Inch	Size	mm				
1C977-12-8	12	1/2	-8	12.7	M20x1.5	61	26	24
1C977-16-8	12	1/2	-8	12.7	M24x1.5	60	25	30
1C977-16-10	16	5/8	-10	15.9	M24x1.5	67	28	30
1C977-20-10	16	5/8	-10	15.9	M30x2	68	28	36
1C977-20-12	19	3/4	-12	19.1	M30x2	76	30	36
1C977-25-12	19	3/4	-12	19.1	M36x2	76.6	30.6	46
1C977-25-12-SW41	19	3/4	-12	19.1	M36x2	77	31	41
1C977-30-12	19	3/4	-12	19.1	M42x2	83	37	50
1C977-25-16	25	1	-16	25.4	M36x2	86	35	46
1C977-30-16	25	1	-16	25.4	M42x2	89	35	50
1C977-30-20	31	1 1/4	-20	31.8	M42x2	102	39	50
1C977-38-20	31	1 1/4	-20	31.8	M52x2	100	36	60
1C977-38-24	38	1 1/2	-24	38.1	M52x2	106	39	60

Fittings with standard O-ring seals can be used for temperatures from -40 °C up to +105 °C.
O-rings see section Eb. Special O-rings are available on request.

OC Female Metric 24° – Swivel Heavy Series with O-Ring 45° Elbow

ISO 12151-2 – SWE -S – DKOS 45°

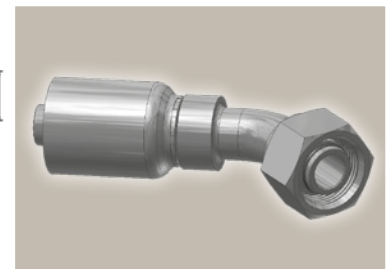
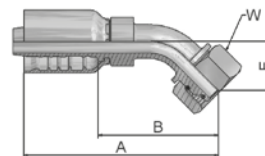

Part Number	Hose I.D.				Thread metric	A mm	B mm	E mm	W mm
	DN	Inch	Size	mm					
10C77-16-8	12	1/2	-8	12.7	M24x1.5	83	49	24	30
10C77-12-10	16	5/8	-10	15.9	M20x1.5	105	66	26	24
10C77-16-10	16	5/8	-10	15.9	M24x1.5	111	64	24	30
10C77-20-10	16	5/8	-10	15.9	M30x2	107	68	28	36
10C77-20-12	19	3/4	-12	19.1	M30x2	120	74	30	36
10C77-25-12	19	3/4	-12	19.1	M36x2	119	73	29	46
10C77-25-12-SW41	19	3/4	-12	19.1	M36x2	119	73	29	41
10C77-30-12	19	3/4	-12	19.1	M42x2	121	75	30	50
10C77-25-16	25	1	-16	25.4	M36x2	142	88	33	46
10C77-30-16	25	1	-16	25.4	M42x2	142	88	33	50
10C77-30-20	31	1 1/4	-20	31.8	M42x2	155	91	34	50
10C77-38-20	31	1 1/4	-20	31.8	M52x2	161	97	37	60
10C77-38-24	38	1 1/2	-24	38.1	M52x2	195	128	49	60

Fittings with standard O-ring seals can be used for temperatures from -40 °C up to +105 °C.
O-rings see section Eb. Special O-rings are available on request.

Approved **fitting series** for hose types, depending on size:

77	387	387ST	387TC	487	487ST	487TC	787	787TC	787ST	797	797TC	797ST	797RH	SX42 ...
	SX42LT		SX42TC											

1C Female Metric 24° – Swivel Heavy Series with O-Ring 90° Elbow

ISO 12151-2-SWE-S – DKOS 90°

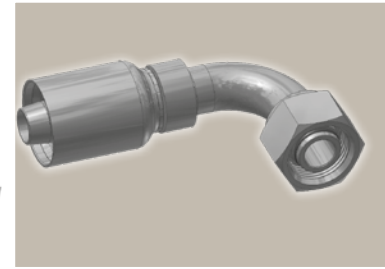
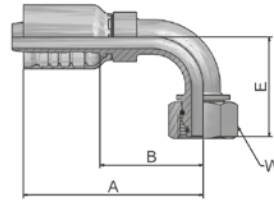

Part Number	Hose I.D.				Thread metric	A mm	B mm	E mm	W mm
	DN	Inch	Size	mm					
11C77-16-8	12	1/2	-8	12.7	M24x1.5	77	42	45	30
11C77-16-10	16	5/8	-10	15.9	M24x1.5	92	53	45	30
11C77-20-10	16	5/8	-10	15.9	M30x2	92	53	53	36
11C77-20-12	19	3/4	-12	19.1	M30x2	108	62	60	36
11C77-25-12	19	3/4	-12	19.1	M36x2	108	62	58.5	46
11C77-25-12-SW41	19	3/4	-12	19.1	M36x2	108	62	59	41
11C77-30-12	19	3/4	-12	19.1	M42x2	108	62	61	50
11C77-25-16	25	1	-16	25.4	M36x2	131	77	69	46
11C77-30-16	25	1	-16	25.4	M42x2	131	77	69	50
11C77-30-20	31	1 1/4	-20	31.8	M42x2	145	82	73	50
11C77-38-20	31	1 1/4	-20	31.8	M52x2	151	87	78	60
11C77-38-24	38	1 1/2	-24	38.1	M52x2	179	112	101	60

Fittings with standard O-ring seals can be used for temperatures from -40 °C up to +105 °C. O-rings see section Eb. Special O-rings are available on request.

D2 Male Metric 24° – Rigid Heavy Series – Straight

ISO 12151-2-S-S – CES

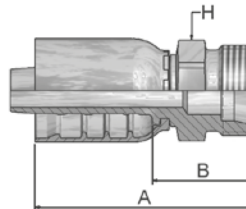

Part Number	Hose I.D.				Thread metric	A mm	B mm	H mm
	DN	Inch	Size	mm				
1D277-16-8	12	1/2	-8	12.7	M24x1.5	64	30	24
1D277-16-10	16	5/8	-10	15.9	M24x1.5	69	30	24
1D277-20-10	16	5/8	-10	15.9	M30x2	72	34	30
1D277-20-12	19	3/4	-12	19.1	M30x2	84	38	30
1D277-25-12	19	3/4	-12	19.1	M36x2	86	40	36
1D277-25-16	25	1	-16	25.4	M36x2	96	42	36
1D277-30-16	25	1	-16	25.4	M42x2	99	45	46
1D277-30-20	31	1 1/4	-20	31.8	M42x2	110	47	46
1D277-38-20	31	1 1/4	-20	31.8	M52x2	114	51	55
1D277-38-24	38	1 1/2	-24	38.1	M52x2	120	53	55

Approved **fitting series** for **hose types**, depending on size:

77	387	387ST	387TC	487	487ST	487TC	787	787TC	787ST	797	797TC	797ST	797RH	SX42 ...
SX42LT SX42TC														

EA **BSP Swivel Female
with O-Ring (60° Cone)**
BS 5200 – ISO 12151-6 – DKOR

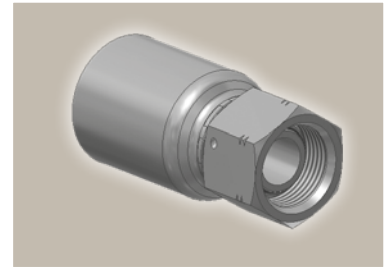
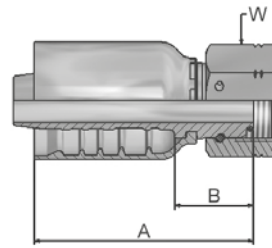

Part Number	Hose I.D.				Thread BSP	A mm	B mm	W mm
	DN	Inch	Size	mm				
1EA77-8-8	12	1/2	-8	12.7	1/2x14	58	23	27
1EA77-10-10	16	5/8	-10	15.9	5/8x14	62	23	30
1EA77-12-10	16	5/8	-10	15.9	3/4x14	63	24	32
1EA77-12-12	19	3/4	-12	19.1	3/4x14	72	26	32
1EA77-16-12	19	3/4	-12	19.1	1x11	82	36	41
1EA77-12-16	25	1	-16	25.4	3/4x14	83	29	32
1EA77-16-16	25	1	-16	25.4	1x11	90	36	41
1EA77-20-20	31	1 1/4	-20	31.8	1 1/4x11	96	33	50
1EA77-24-24	38	1 1/2	-24	38.1	1 1/2	103	36	55
1EA77-32-32	51	2	-32	50.8	2	118	40	70

Fittings with standard O-ring seals can be used for temperatures from -40 °C up to +105 °C.
O-rings see section Eb. Special O-rings are available on request.

EB **BSP Swivel Female
with O-Ring
45° Elbow (60° Cone)**
BS 5200 – ISO 12151-6 – DKOR 45°

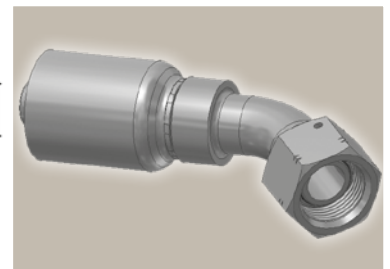
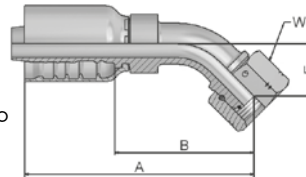

Part Number	Hose I.D.				Thread BSP	A mm	B mm	E mm	W mm
	DN	Inch	Size	mm					
1EB77-8-8	12	1/2	-8	12.7	1/2x14	80	45	20	27
1EB77-10-10	16	5/8	-10	15.9	5/8x14	101	62	22	30
1EB77-12-10	16	5/8	-10	15.9	3/4x14	103	64	24	32
1EB77-12-12	19	3/4	-12	19.1	3/4x14	117	71	27	32
1EB77-16-12	19	3/4	-12	19.1	1x11	120	74	29	41
1EB77-16-16	25	1	-16	25.4	1x11	144	90	35	41
1EB77-20-20	31	1 1/4	-20	31.8	1 1/4x11	159	95	35	50
1EB77-24-24	38	1 1/2	-24	38.1	1 1/2	196	129	50	55
1EB77-32-32	51	2	-32	50.8	2	255	178	86	70

Fittings with standard O-ring seals can be used for temperatures from -40 °C up to +105 °C.
O-rings see section Eb. Special O-rings are available on request.

Approved **fitting series** for hose types, depending on size:

77	387	387ST	387TC	487	487ST	487TC	787	787TC	787ST	797	797TC	797ST	797RH	SX42	...
	SX42LT		SX42TC												

EC **BSP Swivel Female
with O-Ring
90° Elbow (60° Cone)**

BS 5200 – ISO 12151-6 – DKOR 90°

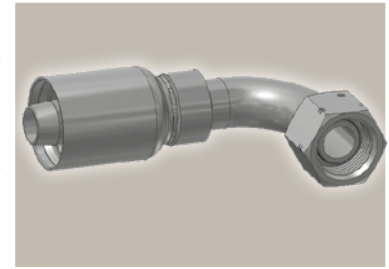
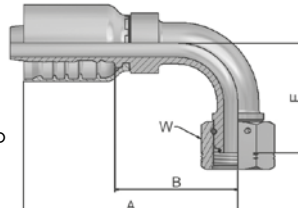

Part Number	Hose I.D.				Thread BSP	A mm	B mm	E mm	W mm
	DN	Inch	Size	mm					
1EC77-8-8	12	1/2	-8	12.7	1/2x14	76	41	40	27
1EC77-10-10	16	5/8	-10	15.9	5/8x14	92	53	44	30
1EC77-12-10	16	5/8	-10	15.9	3/4x14	92	53	47	32
1EC77-12-12	19	3/4	-12	19.1	3/4x14	108	62	55	32
1EC77-16-12	19	3/4	-12	19.1	1x11	108	62	59	41
1EC77-16-16	25	1	-16	25.4	1x11	131	77	72	41
1EC77-20-20	31	1 1/4	-20	31.8	1 1/4x11	151	87	75	50
1EC77-24-24	38	1 1/2	-24	38.1	1 1/2	179	112	103	55
1EC77-32-32	51	2	-32	50.8	2	236	159	150	70

Fittings with standard O-ring seals can be used for temperatures from -40 °C up to +105 °C.
O-rings see section Eb. Special O-rings are available on request.

D9 **Male BSP Parallel Pipe
Rigid – Straight (60° Cone)**

BS5200 – AGR

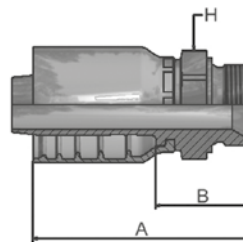

Part Number	Hose I.D.				Thread BSP	A mm	B mm	H mm
	DN	Inch	Size	mm				
1D977-8-8	12	1/2	-8	12.7	1/2x14	68	33	27
1D977-10-10	16	5/8	-10	15.9	5/8x14	74	36	30
1D977-12-12	19	3/4	-12	19.1	3/4x14	87	41	32
1D977-16-12	19	3/4	-12	19.1	1x11	91	45	41
1D977-16-16	25	1	-16	25.4	1x11	91	45	41
1D977-20-16	25	1	-16	25.4	1 1/4x11	103	49	50
1D977-20-20	31	1 1/4	-20	31.8	1 1/4x11	113	50	50
1D977-24-24	38	1 1/2	-24	38.1	1 1/2x11	124	57	55

Approved **fitting series** for **hose types**, depending on size:

77	387	387ST	387TC	487	487ST	487TC	787	787TC	787ST	797	797TC	797ST	797RH	SX42 ...
SX42LT SX42TC														

01

Male NPTF Pipe Rigid – Straight

SAE J476A/ J516 – AGN

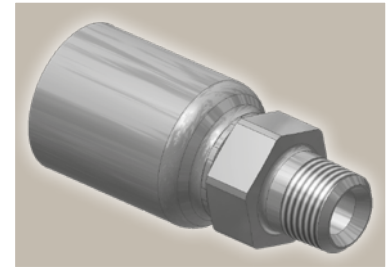
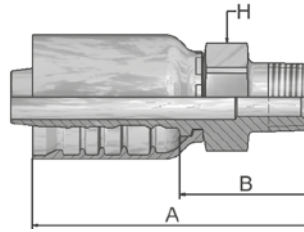

Part Number	Hose I.D.				Thread NPTF	A mm	B mm	H mm
	DN	Inch	Size	mm				
10177-8-8	12	1/2	-8	12.7	1/2-14	69	35	22
10177-8-12	19	3/4	-12	19.1	1/2-14	87	41	30
10177-12-12	19	3/4	-12	19.1	3/4-14	87	41	30
10177-16-16	25	1	-16	25.4	1-11 1/2	103	49	36
10177-20-20	31	1 1/4	-20	31.8	1 1/4-11 1/2	116	53	46
10177-24-24	38	1 1/2	-24	38.1	1 1/2-11 1/2	124	57	50
10177-32-32	51	2	-32	50.8	2-11 1/2	143	66	65

All sizes of 10177 fittings are rated at 35,0 MPa working pressure.

03

Male JIC 37° – Rigid Straight

ISO12151-5-S – AGJ

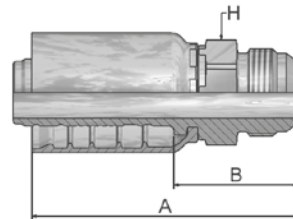

Part Number	Hose I.D.				Thread UNF	A mm	B mm	H mm
	DN	Inch	Size	mm				
10377-8-8	12	1/2	-8	12.7	3/4x16	66.45	32	22
10377-10-8	12	1/2	-8	12.7	7/8x14	69	34	24
10377-12-8	12	1/2	-8	12.7	1 1/16x12	77	42	27
10377-10-10	16	5/8	-10	15.9	7/8x14	76	38	24
10377-12-10	16	5/8	-10	15.9	1 1/16x12	82	43	30
10377-10-12	19	3/4	-12	19.1	7/8x14	87	41	30
10377-12-12	19	3/4	-12	19.1	1 1/16x12	89	43	30
10377-16-12	19	3/4	-12	19.1	1 5/16x12	92	46	36
10377-16-16	25	1	-16	25.4	1 5/16x12	101.4	47	36
10377-20-16	25	1	-16	25.4	1 5/8x12	110	56	50
10377-20-20	31	1 1/4	-20	31.8	1 5/8x12	118	55	50
10377-32-32	51	2	-32	50.8	2 1/2x12	148	71	65

All sizes of 10377 fittings are rated at 35,0 MPa working pressure.

Approved **fitting series** for hose types, depending on size:

77	387	387ST	387TC	487	487ST	487TC	787	787TC	787ST	797	797TC	797ST	797RH	SX42	...
	SX42LT		SX42TC												

06 Female JIC 37° – Swivel Straight

ISO12151-5-SWS – DKJ

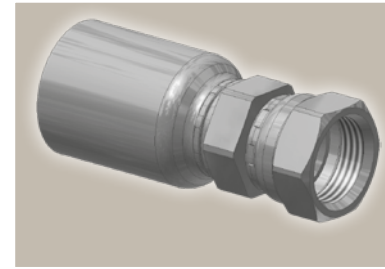
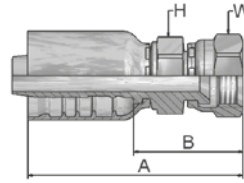

Part Number	Hose I.D.				Thread UNF	A mm	B mm	H mm	W mm
	DN	Inch	Size	mm					
10677-8-8	12	1/2	-8	12.7	3/4x16	71	37	22	22
10677-10-8	12	1/2	-8	12.7	7/8x14	74	39	22	27
10677-12-8	12	1/2	-8	12.7	1 1/16x12	80	46	30	32
10677-10-10	16	5/8	-10	15.9	7/8x14	81	42	24	27
10677-12-10	16	5/8	-10	15.9	1 1/16x12	84	45	30	32
10677-10-12	19	3/4	-12	19.1	7/8x14	92	46	30	27
10677-12-12	19	3/4	-12	19.1	1 1/16x12	94	48	30	32
10677-14-12	19	3/4	-12	19.1	1 3/16x12	99	53	36	36
10677-16-12	19	3/4	-12	19.1	1 5/16x12	99	53	36	41
10677-12-16	25	1	-16	25.4	1 1/16x12	102	48	36	32
10677-16-16	25	1	-16	25.4	1 5/16x12	106	52	36	41
10677-20-16	25	1	-16	25.4	1 5/8x12	109	55	41	50
10677-16-20	31	1 1/4	-20	31.8	1 5/16x12	120	57	46	41
10677-20-20	31	1 1/4	-20	31.8	1 5/8 12	124	60	46	50
10677-24-20	31	1 1/4	-20	31.8	1 7/8x12	108	44	50	60
10677-24-24	38	1 1/2	-24	38.1	1 7/8x12	136	69	50	60
10677-32-32	51	2	-32	50.8	2 1/2x12	160	83	65	75

All sizes of 10677 fittings are rated at 35,0 MPa working pressure.

Approved **fitting series** for **hose types**, depending on size:

77	387	387ST	387TC	487	487ST	487TC	787	787TC	787ST	797	797TC	797ST	797RH	SX42	...
	SX42LT	SX42TC													

37 Female JIC 37° – Swivel 45° Elbow

ISO 12151-5-SWE 45° – DKJ 45°

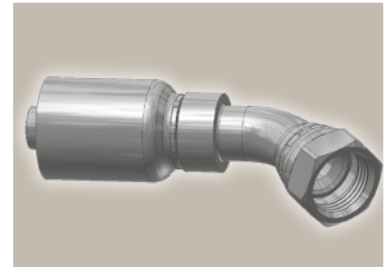
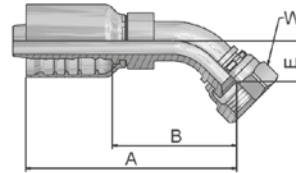

Part Number	Hose I.D.				Thread UNF	A mm	B mm	E mm	W mm
	DN	Inch	Size	mm					
13777-8-8	12	1/2	-8	12.7	3/4x16	73	38	15	22
13777-10-8	12	1/2	-8	12.7	7/8x14	78	43	16	27
13777-12-8	12	1/2	-8	12.7	1 1/16x12	79	44	21	32
13777-10-10	16	5/8	-10	15.9	7/8x14	93	54	16	27
13777-12-10	16	5/8	-10	15.9	1 1/16x12	100	61	21	32
13777-10-12	19	3/4	-12	19.1	7/8x14	102	56	16	27
13777-12-12	19	3/4	-12	19.1	1 1/16x12	111	65	21	32
13777-16-12	19	3/4	-12	19.1	1 5/16x12	114	68	24	41
13777-16-16	25	1	-16	25.4	1 5/16x12	133	79	24	41
13777-20-20	31	1 1/4	-20	31.8	1 5/8x12	153	90	32	50
13777-24-24	38	1 1/2	-24	38.1	1 7/8x12	201	134	58	60
13777-32-32	51	2	-32	50.8	2 1/2x12	258	181	72	75

All sizes of 13777 fittings are rated at 35,0 MPa working pressure.

39 Female JIC 37° – Swivel 90° Elbow

ISO 12151-5-SWES – DKJ 90°

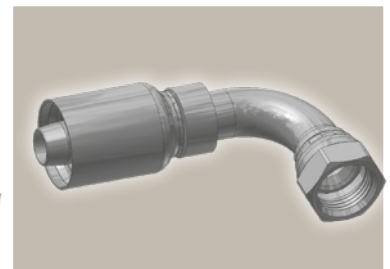
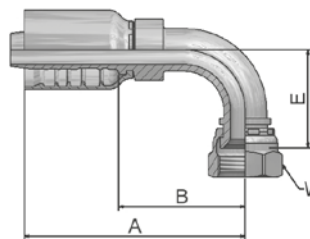

Part Number	Hose I.D.				Thread UNF	A mm	B mm	E mm	W mm
	DN	Inch	Size	mm					
13977-8-8	12	1/2	-8	12.7	3/4x16	71	36	29	22
13977-10-8	12	1/2	-8	12.7	7/8x14	71	36	32	27
13977-12-8	12	1/2	-8	12.7	1 1/16x12	76	41	48	32
13977-10-10	16	5/8	-10	15.9	7/8x14	88	50	33	27
13977-12-10	16	5/8	-10	15.9	1 1/16x12	92	53	48	32
13977-10-12	19	3/4	-12	19.1	7/8x14	97	51	33	27
13977-12-12	19	3/4	-12	19.1	1 1/16x12	108	62	48	32
13977-16-12	19	3/4	-12	19.1	1 5/16x12	108	62	56	41
13977-16-16	25	1	-16	25.4	1 5/16x12	131	77	74	41
13977-20-20	31	1 1/4	-20	31.8	1 5/8x12	148	84	78	50
13977-24-24	38	1 1/2	-24	38.1	1 7/8x12	175	108	102	60
13977-32-32	51	2	-32	50.8	2 1/2x12	236	159	152	75

All sizes of 13977 fittings are rated at 35,0 MPa working pressure.

Approved **fitting series** for hose types, depending on size:

77	387	387ST	387TC	487	487ST	487TC	787	787TC	787ST	797	797TC	797ST	797RH	SX42	...
	SX42LT		SX42TC												

15/4A ISO 6162-1-Flange Straight

ISO 12151-3-S-L – SFL
(35.0 MPa/ 5000 psi)

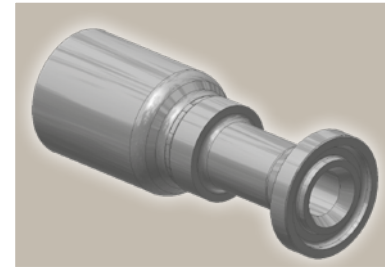
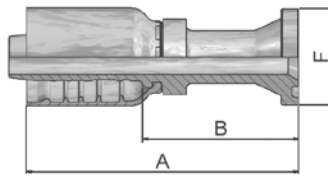

Part Number	Hose I.D.				Flange Inch	A mm	B mm	F mm
	DN	Inch	Size	mm				
11577-8-8	12	1/2	-8	12.7	1/2	90	55	30
11577-12-8	12	1/2	-8	12.7	3/4	67	33	38
11577-10-10	16	5/8	-10	15.9	5/8	100	60	34
11577-12-10	16	5/8	-10	15.9	3/4	75	36	38
11577-12-12	19	3/4	-12	19.1	3/4	107	62	38
11577-16-12	19	3/4	-12	19.1	1	88	42	45
11577-16-16	25	1	-16	25.4	1	119	65	45
14A77-20-16	25	1	-16	25.4	1 1/4	90	36	51
11577-16-20	31	1 1/4	-20	31.8	1	130	66	45
14A77-20-20	31	1 1/4	-20	31.8	1 1/4	138	74	51
14A77-24-20	31	1 1/4	-20	31.8	1 1/2	100	37	60
14A77-20-24	38	1 1/2	-24	38.1	1 1/4	146	79	51
14A77-24-24	38	1 1/2	-24	38.1	1 1/2	140	73	60
14A77-32-24	38	1 1/2	-24	38.1	2	117	50	71
14A77-32-32	51	2	-32	50.8	2	163	86	71

SAE flange halves see in section Eb.

Fittings with standard O-ring seals can be used for temperatures from -40 °C up to +105 °C.
O-rings see section Eb. Special O-rings are available on request.

Approved **fitting series** for **hose types**, depending on size:

77	387	387ST	387TC	487	487ST	487TC	787	787TC	787ST	797	797TC	797ST	797RH	SX42	...
	SX42LT	SX42TC													

17/4F ISO 6162-1-Flange 45° Elbow

ISO 12151-3 – E45S – L – SFL 45°
(35.0 MPa/ 5000 psi)

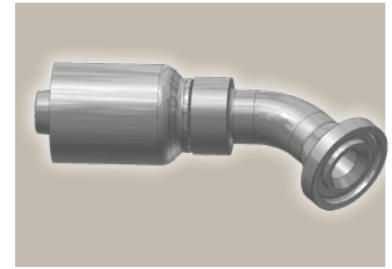
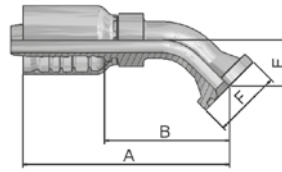

Part Number	Hose I.D.				Flange Inch	A mm	B mm	E mm	F mm
	DN	Inch	Size	mm					
11777-8-8	12	1/2	-8	12.7	1/2	79	45	20	30
11777-12-8	12	1/2	-8	12.7	3/4	81	47	22	38
11777-10-10	16	5/8	-10	15.9	5/8	103	64	24	34
11777-12-12	19	3/4	-12	19.1	3/4	116	70	26	38
11777-16-12	19	3/4	-12	19.1	1	116	70	26	45
11777-16-16	25	1	-16	25.4	1	130	76	32	45
14F77-20-16	25	1	-16	25.4	1 1/4	130	76	32	51
14F77-20-20	31	1 1/4	-20	31.8	1 1/4	167	104	38	51
14F77-24-20	31	1 1/4	-20	31.8	1 1/2	167	104	38	60
14F77-24-24	38	1 1/2	-24	38.1	1 1/2	192	125	44	60
14F77-32-24	38	1 1/2	-24	38.1	2	192	125	44	71
14F77-32-32	51	2	-32	50.8	2	211	134	56	71

SAE flange halves see in section Eb.

Fittings with standard O-ring seals can be used for temperatures from -40 °C up to +105 °C.
O-rings see section Eb. Special O-rings are available on request.

Approved **fitting series** for hose types, depending on size:

77	387	387ST	387TC	487	487ST	487TC	787	787TC	787ST	797	797TC	797ST	797RH	SX42 ...
	SX42LT	SX42TC												

19/4N ISO 6162-1-Flange 90° Elbow

ISO 12151-3-E-L – SFL 90°
(35.0 MPa/ 5000 psi)

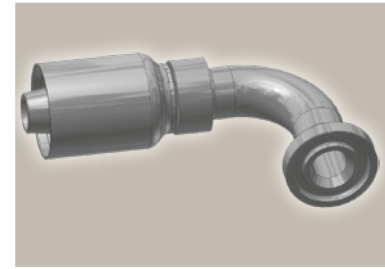
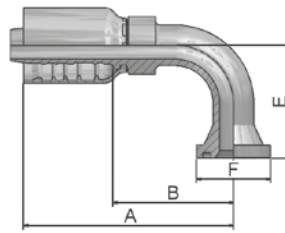

Part Number	Hose I.D.				Flange Inch	A mm	B mm	E mm	F mm
	DN	Inch	Size	mm					
11977-8-8	12	1/2	-8	12.7	1/2	76	41	41	30
11977-12-8	12	1/2	-8	12.7	3/4	80	45	42	38
11977-10-10	16	5/8	-10	15.9	5/8	92	53	53	34
11977-12-12	19	3/4	-12	19.1	3/4	108	62	58	38
11977-16-12	19	3/4	-12	19.1	1	108	62	58	45
11977-16-16	25	1	-16	25.4	1	120	66	70	45
14N77-20-16	25	1	-16	25.4	1 1/4	120	66	70	51
11977-16-20	31	1 1/4	-20	31.8	1	156	92	90	45
14N77-20-20	31	1 1/4	-20	31.8	1 1/4	156	92	90	51
14N77-24-20	31	1 1/4	-20	31.8	1 1/2	156	92	90	60
14N77-24-24	38	1 1/2	-24	38.1	1 1/2	180	113	104	60
14N77-32-24	38	1 1/2	-24	38.1	2	180	113	104	71
14N77-32-32	51	2	-32	50.8	2	206	129	138	71

SAE flange halves see in section Eb.

Fittings with standard O-ring seals can be used for temperatures from -40 °C up to +105 °C.

O-rings see section Eb. Special O-rings are available on request.

Approved **fitting series** for **hose types**, depending on size:

77	387	387ST	387TC	487	487ST	487TC	787	787TC	787ST	797	797TC	797ST	797RH	SX42	...
	SX42LT	SX42TC													

6A ISO 6162-2-Flange Straight

ISO 12151-3-S-S – SFS
(42.0 MPa/ 6000 psi)

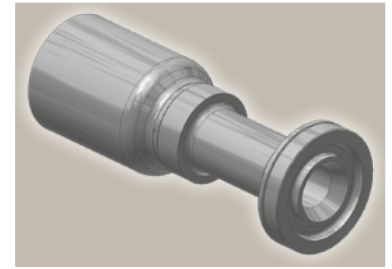
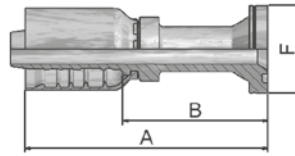

Part Number	Hose I.D.				Flange Inch	A mm	B mm	F mm
	DN	Inch	Size	mm				
16A77-8-8	12	1/2	-8	12.7	1/2	89	55	32
16A77-12-8	12	1/2	-8	12.7	3/4	69.4	34.75	41
16A77-12-10	16	5/8	-10	15.9	3/4	75	36	41
16A77-16-10	16	5/8	-10	15.9	1	80	41	48
16A77-8-12	19	3/4	-12	19.1	1/2	106	60	32
16A77-12-12	19	3/4	-12	19.1	3/4	114.2	68.2	41
16A77-16-12	19	3/4	-12	19.1	1	88.2	42	48
16A77-20-12	19	3/4	-12	19.1	1 1/4	93	47	54
16A77-12-16	25	1	-16	25.4	3/4	126	72	41
16A77-16-16	25	1	-16	25.4	1	113	59	48
16A77-20-16	25	1	-16	25.4	1 1/4	103	49	54
16A77-16-20	31	1 1/4	-20	31.8	1	145	82	48
16A77-20-20	31	1 1/4	-20	31.8	1 1/4	146	82	54
16A77-24-20	31	1 1/4	-20	31.8	1 1/2	118	55	64
16A77-20-24	38	1 1/2	-24	38.1	1 1/4	154	87	54
16A77-24-24	38	1 1/2	-24	38.1	1 1/2	162	96	64
16A77-32-24	38	1 1/2	-24	38.1	2	133	66	79
16A77-32-32	51	2	-32	50.8	2	183	105	79

SAE flange halves see in section Eb.

Fittings with standard O-ring seals can be used for temperatures from -40 °C up to +105 °C.

O-rings see section Eb. Special O-rings are available on request.

Approved **fitting series** for **hose types**, depending on size:

77	387	387ST	387TC	487	487ST	487TC	787	787TC	787ST	797	797TC	797ST	797RH	SX42	...
	SX42LT	SX42TC													

6E ISO 6162-2 Flange 30° Elbow

SFS 30°
(42.0 MPa/ 6000 psi)

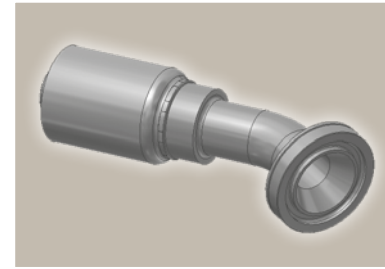
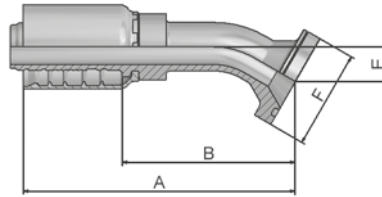

Part Number	Hose I.D.				Flange Inch	A mm	B mm	E mm	F mm
	DN	Inch	Size	mm					
16E77-12-12	19	3/4	-12	19.1	3/4	121	75	16	41
16E77-16-12	19	3/4	-12	19.1	1	122	76	16	48
16E77-16-16	25	1	-16	25.4	1	136	82	19	48
16E77-20-16	25	1	-16	25.4	1 1/4	149	95	19	54
16E77-20-20	31	1 1/4	-20	31.8	1 1/4	175	111	24	54
16E77-24-24	38	1 1/2	-24	38.1	1 1/2	190	123	30	64
16E77-32-32	51	2	-32	50.8	2	223	145	32	79

SAE flange halves see in section Eb.

Fittings with standard O-ring seals can be used for temperatures from -40 °C up to +105 °C.
O-rings see section Eb. Special O-rings are available on request.

6F ISO 6162-2-Flange 45° Elbow – Heavy Series

ISO 12151-3 – E45-S – SFS 45°
(42.0 MPa/ 6000 psi)

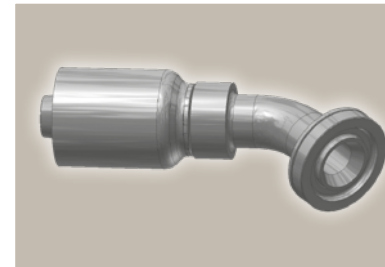
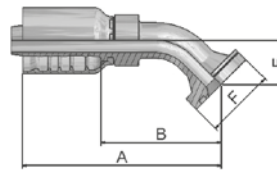

Part Number	Hose I.D.				Flange Inch	A mm	B mm	E mm	F mm
	DN	Inch	Size	mm					
16F77-8-8	12	1/2	-8	12.7	1/2	79	44	19	32
16F77-12-8	12	1/2	-8	12.7	3/4	85.8	51	26	41
16F77-8-10	16	5/8	-10	15.9	1/2	105	66	26	32
16F77-12-10	16	5/8	-10	15.9	3/4	104	66	26	41
16F77-16-10	16	5/8	-10	15.9	1	105	66	26	48
16F77-12-12	19	3/4	-12	19.1	3/4	116.2	70	26	41
16F77-16-12	19	3/4	-12	19.1	1	116	70	26	48
16F77-12-16	25	1	-16	25.4	3/4	132	78	32	41
16F77-16-16	25	1	-16	25.4	1	141	87	32	48
16F77-20-16	25	1	-16	25.4	1 1/4	142	88	32	54
16F77-16-20	31	1 1/4	-20	31.8	1	154	90	38	48
16F77-20-20	31	1 1/4	-20	31.8	1 1/4	167	104	38	54
16F77-24-20	31	1 1/4	-20	31.8	1 1/2	173	110	44	64
16F77-20-24	38	1 1/2	-24	38.1	1 1/4	184	117	44	54
16F77-24-24	38	1 1/2	-24	38.1	1 1/2	192	125	44	64
16F77-32-24	38	1 1/2	-24	38.1	2	192	125	44	79
16F77-32-32	51	2	-32	50.8	2	218	141	56	79

SAE flange halves see in section Eb.

Fittings with standard O-ring seals can be used for temperatures from -40 °C up to +105 °C.
O-rings see section Eb. Special O-rings are available on request.

Approved **fitting series** for **hose types**, depending on size:



77	387	387ST	387TC	487	487ST	487TC	787	787TC	787ST	797	797TC	797ST	797RH	SX42 ...
SX42LT SX42TC														

6N

ISO 6162-2-Flange 90° Elbow

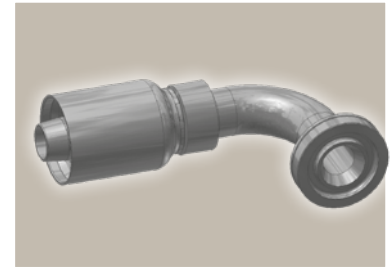
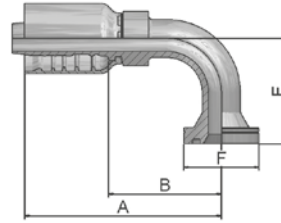
ISO 12151-3 – E-S – SFS 90°
(42.0 MPa/ 6000 psi)



Part Number	 Hose I.D.				 Flange	A	B	E	F
	DN	Inch	Size	mm					
16N77-8-8	12	1/2	-8	12.7	1/2	76	41	41	32
16N77-12-8	12	1/2	-8	12.7	3/4	81.05	47	45	41
16N77-8-10	16	5/8	-10	15.9	1/2	92	53	54	32
16N77-12-10	16	5/8	-10	15.9	3/4	92	53	54	41
16N77-16-10	16	5/8	-10	15.9	1	92	53	54	48
16N77-12-12	19	3/4	-12	19.1	3/4	108.2	62	58	41
16N77-16-12	19	3/4	-12	19.1	1	108	62	58	48
16N77-20-12	19	3/4	-12	19.1	1 1/4	108	62	63	54
16N77-12-16	25	1	-16	25.4	3/4	115	61	70	41
16N77-16-16	25	1	-16	25.4	1	127	66	70	48
16N77-20-16	25	1	-16	25.4	1 1/4	135	81	70	54
16N77-16-20	31	1 1/4	-20	31.8	1	138	75	90	48
16N77-20-20	31	1 1/4	-20	31.8	1 1/4	156	92	90	54
16N77-24-20	31	1 1/4	-20	31.8	1 1/2	151	87	90	64
16N77-20-24	38	1 1/2	-24	38.1	1 1/4	156	89	104	54
16N77-24-24	38	1 1/2	-24	38.1	1 1/2	180	113	104	64
16N77-32-24	38	1 1/2	-24	38.1	2	175	108	104	79
16N77-32-32	51	2	-32	50.8	2	223	138	138	79

SAE flange halves see in section Eb.

Fittings with standard O-ring seals can be used for temperatures from -40 °C up to +105 °C.

O-rings see section Eb. Special O-rings are available on request.



Approved **fitting series** for **hose types**, depending on size:

77	387	387ST	387TC	487	487ST	487TC	787	787TC	787ST	797	797TC	797ST	797RH	SX42	...
	SX42LT	SX42TC													

X5 Flange – Straight

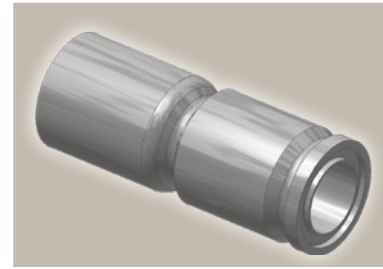
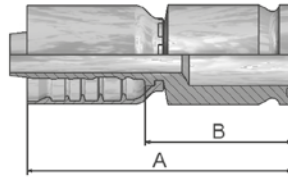
Full flange system for
ISO 6162-1 or ISO 6162-2





Part Number	 Hose I.D.				 Flange	A mm	B mm
	DN	Inch	Size	mm	Inch		
1X577-12-12	19	3/4	-12	19.1	3/4	103	57
1X577-16-12	19	3/4	-12	19.1	1	103	57
1X577-16-16	25	1	-16	25.4	1	113	59
1X577-20-16	25	1	-16	25.4	1 1/4	113	59
1X577-20-20	31	1 1/4	-20	31.8	1 1/4	124	57
1X577-24-24	38	1 1/2	-24	38.1	1 1/2	129	62
1X577-32-32	51	2	-32	50.8	2	154	77

Full flange system see Eb-4.

X7 Flange – 45° Elbow

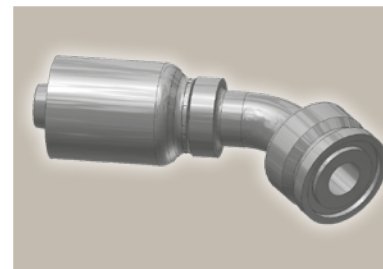
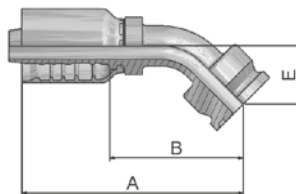
Full flange system for
ISO 6162-1 or ISO 6162-2



Part Number	 Hose I.D.				 Flange	A mm	B mm	E mm
	DN	Inch	Size	mm	Inch			
1X777-12-12	19	3/4	-12	19.1	3/4	119	73	29
1X777-16-12	19	3/4	-12	19.1	1	118	72	29
1X777-16-16	25	1	-16	25.4	1	141	87	32
1X777-20-16	25	1	-16	25.4	1 1/4	147	93	38
1X777-16-20	31	1 1/4	-20	31.8	1	146	82	38
1X777-20-20	31	1 1/4	-20	31.8	1 1/4	159	96	38
1X777-24-20	31	1 1/4	-20	31.8	1 1/2	165	102	44
1X777-24-24	38	1 1/2	-24	38.1	1 1/2	183	116	45

Full flange system see Eb-4.

Approved **fitting series** for **hose types**, depending on size:

77	387	387ST	387TC	487	487ST	487TC	787	787TC	787ST	797	797TC	797ST	797RH	SX42 ...
SX42LT SX42TC														

X9 Flange – 90° Elbow

Full flange system for
ISO 6162-1 or ISO 6162-2

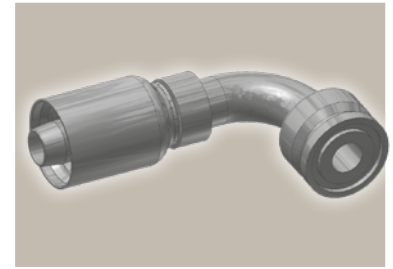
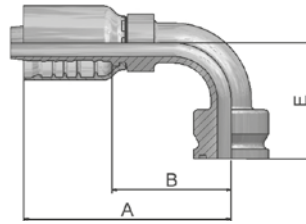

Part Number	Hose I.D.				Flange Inch	A mm	B mm	E mm
	DN	Inch	Size	mm				
1X977-8-8	12	1/2	-8	12.7	1/2	81	45	43
1X977-12-12	19	3/4	-12	19.1	3/4	108	62	61
1X977-16-12	19	3/4	-12	19.1	1	108	62	61
1X977-12-16	25	1	-16	25.4	3/4	110	56	70
1X977-16-16	25	1	-16	25.4	1	131	77	70
1X977-20-16	25	1	-16	25.4	1 1/4	131	77	70
1X977-16-20	31	1 1/4	-20	31.8	1	130	67	90
1X977-20-20	31	1 1/4	-20	31.8	1 1/4	148	84	90
1X977-24-20	31	1 1/4	-20	31.8	1 1/2	148	84	90
1X977-24-24	38	1 1/2	-24	38.1	1 1/2	180	113	104
1X977-32-32	51	2	-32	50.8	2	221	144	138

Full flange system see Eb-4.

XA Caterpillar® Flange Straight

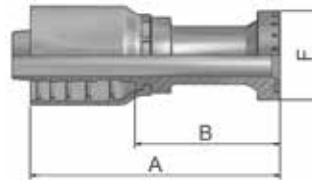



Part Number	Hose I.D.				Flange Inch	A mm	B mm	F mm
	DN	Inch	Size	mm				
1XA77-12-12	19	3/4	-12	19.1	3/4	114	68	41
1XA77-16-12	19	3/4	-12	19.1	3/4	88	42	48
1XA77-16-16	25	1	-16	25.4	1	141	87	48
1XA77-20-16	25	1	-16	25.4	1	104	50	54
1XA77-20-20	31	1 1/4	-20	31.8	1 1/4	152	88	54
1XA77-24-20	31	1 1/4	-20	31.8	1 1/2	121	57	64
1XA77-24-24	38	1 1/2	-24	38.1	1 1/2	176	109	64
1XA77-32-24	38	1 1/2	-24	38.1	2	133	66	79
1XA77-32-32	51	2	-32	50.8	2	192	115	79

Approved **fitting series** for hose types, depending on size:

77	387	387ST	387TC	487	487ST	487TC	787	787TC	787ST	797	797TC	797ST	797RH	SX42	...
	SX42LT		SX42TC												

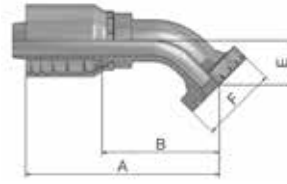

XF Caterpillar® Flange
45° Elbow

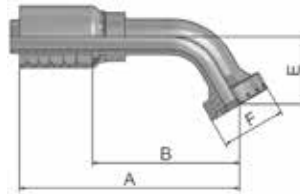

Part Number	 Hose I.D.				 Flange	A mm	B mm	E mm	F mm
	DN	Inch	Size	mm	Inch				
1XF77-12-12	19	3/4	-12	19.1	3/4	122	76	31	41
1XF77-16-16	25	1	-16	25.4	1	145	91	36	48
1XF77-20-20	31	1 1/4	-20	31.8	1 1/4	166	103	37	54
1XF77-24-20	31	1 1/4	-20	31.8	1 1/2	166	103	37	64

XG Caterpillar® Flange
60° Elbow



Part Number	 Hose I.D.				 Flange	A mm	B mm	E mm	F mm
	DN	Inch	Size	mm	Inch				
1XG77-12-12	19	3/4	-12	19.1	3/4	137	91	42	41
1XG77-16-16	25	1	-16	25.4	1	163	109	50	48
1XG77-20-20	31	1 1/4	-20	31.8	1 1/4	205	141	51	54

Approved **fitting series** for **hose types**, depending on size:

77	387	387ST	387TC	487	487ST	487TC	787	787TC	787ST	797	797TC	797ST	797RH	SX42	...
	SX42LT	SX42TC													

XN Caterpillar® Flange
90° Elbow

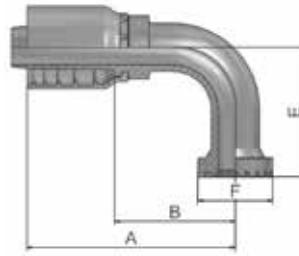

Part Number	Hose I.D.				Flange Inch	A mm	B mm	E mm	F mm
	DN	Inch	Size	mm					
1XN77-12-12	19	3/4	-12	19.1	3/4	108	62	63	41
1XN77-16-12	19	3/4	-12	19.1	1	108	62	63	48
1XN77-16-16	25	1	-16	25.4	1	131	77	74	48
1XN77-20-16	25	1	-16	25.4	1 1/4	131	77	74	54
1XN77-20-20	31	1 1/4	-20	31.8	1 1/4	156	92	94	54
1XN77-24-20	31	1 1/4	-20	31.8	1 1/2	156	92	77	64
1XN77-24-24	38	1 1/2	-24	38.1	1 1/2	160	103	106	79
1XN77-32-24	38	1 1/2	-24	38.1	2	169	103	106	79

K5 Komatsu® Flange
Straight

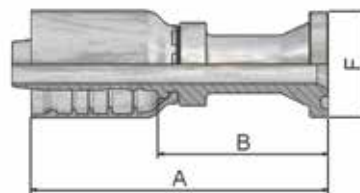



Part Number	Hose I.D.				A mm	B mm
	DN	Inch	Size	mm		
1K577-16-16	25	1	-16	25.4	119	65

Approved **fitting series** for hose types, depending on size:

77	387	387ST	387TC	487	487ST	487TC	787	787TC	787ST	797	797TC	797ST	797RH	SX42	...
	SX42LT		SX42TC												

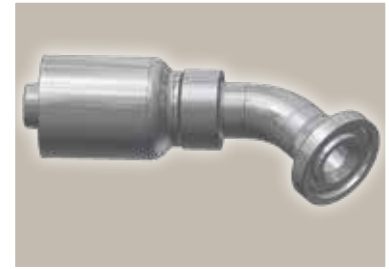
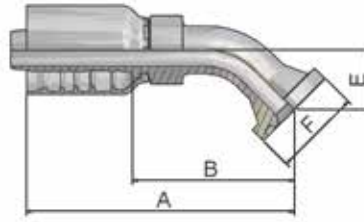
K7 Komatsu® Flange 45° Elbow



Part Number	 Hose I.D.				A mm	B mm	E mm
	DN	Inch	Size	mm			
1K777-12-12	19	3/4	-12	19.1	116	70	26
1K777-16-16	25	1	-16	25.4	143	89	32
1K777-20-20	31	1 1/4	-20	31.8	159	96	38

K9 Komatsu® Flange 90° Elbow

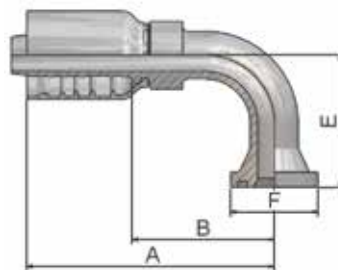

Part Number	 Hose I.D.				A mm	B mm	E mm
	DN	Inch	Size	mm			
1K977-12-12	19	3/4	-12	19.1	108	62	58
1K977-16-16	25	1	-16	25.4	127	73	70
1K977-20-20	31	1 1/4	-20	31.8	148	84	90

Approved **fitting series** for **hose types**, depending on size:

77	387	387ST	387TC	487	487ST	487TC	787	787TC	787ST	797	797TC	797ST	797RH	SX42	...
	SX42LT SX42TC														

JC

Female ORFS Swivel – Straight Short

ISO 12151-1 – SWSA
SAE J516 – ORFS

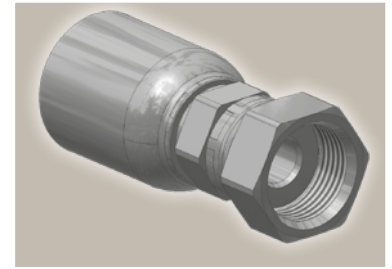
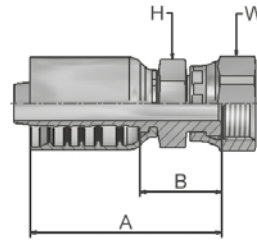

Part Number	Hose I.D.				Thread UNF	A mm	B mm	H mm	W mm
	DN	Inch	Size	mm					
1JC77-8-8	12	1/2	-8	12.7	13/16x16	60	25	22	24
1JC77-10-8	12	1/2	-8	12.7	1x14	65	31	24	30
1JC77-12-8	12	1/2	-8	12.7	1 3/16x12	64	29	30	36
1JC77-10-10	16	5/8	-10	15.9	1x14	70	31	24	30
1JC77-12-10	16	5/8	-10	15.9	1 3/16x16	69	30	30	36
1JC77-10-12	19	3/4	-12	19.1	1x14	79	33	30	30
1JC77-12-12	19	3/4	-12	19.1	1 3/16x12	79	33	30	36
1JC77-16-12	19	3/4	-12	19.1	1 7/16x12	81	35.3	36	41
1JC77-12-16	25	1	-16	25.4	1 3/16x12	92	38	36	36
1JC77-16-16	25	1	-16	25.4	1 7/16x12	91	37.1	36	41
1JC77-20-16	25	1	-16	25.4	1 11/16x12	90	36	41	50
1JC77-20-20	31	1 1/4	-20	31.8	1 11/16x12	107	44	46	50
1JC77-24-24	38	1 1/2	-24	38.1	2x12	109	43	50	60
1JC77-32-32	51	2	-32	50.8	2 1/2x12	143	66	65	75

J7

Female ORFS – Swivel 45° Elbow

ISO 12151-1 – SWE 45°
SAE J516 – ORFS 45°

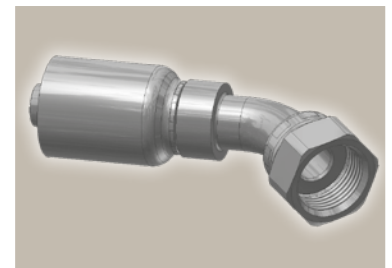
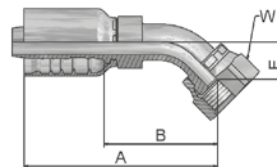

Part Number	Hose I.D.				Thread UNF	A mm	B mm	E mm	W mm
	DN	Inch	Size	mm					
1J777-8-8	12	1/2	-8	12.7	13/16x16	72.7	38	15	24
1J777-10-10	16	5/8	-10	15.9	1x14	86	47	16	30
1J777-12-10	16	5/8	-10	15.9	1 3/16x12	98	59	21	36
1J777-12-12	19	3/4	-12	19.1	1 3/16x12	111	65	21	36
1J777-16-12	19	3/4	-12	19.1	1 7/16x12	114	68	24	41
1J777-16-16	25	1	-16	25.4	1 7/16x12	133	79	24	41
1J777-20-20	31	1 1/4	-20	31.8	1 11/16x12	145	81	25	50
1J777-24-20	31	1 1/4	-20	31.8	2x12	148	84	27	60
1J777-24-24	38	1 1/2	-24	38.1	2x12	176	109	42	60

Approved **fitting series** for hose types, depending on size:

77	387	387ST	387TC	487	487ST	487TC	787	787TC	787ST	797	797TC	797ST	797RH	SX42 ...
	SX42LT		SX42TC											

J9 Female ORFS – Swivel 90° Elbow – Short Drop

ISO 12151-1 – SWES
SAE J516 – ORFS 90°

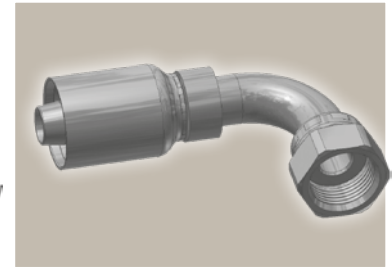
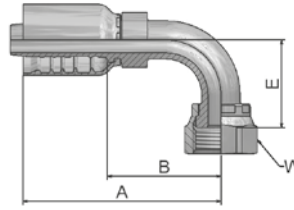

Part Number	Hose I.D.				Thread UNF	A mm	B mm	E mm	W mm
	DN	Inch	Size	mm					
1J977-8-8	12	1/2	-8	12.7	13/16x16	70.65	36	29	24
1J977-10-10	16	5/8	-10	15.9	1x14	97	50	32	30
1J977-12-10	16	5/8	-10	15.9	1 3/16x12	89	50	48	36
1J977-10-12	19	3/4	-12	19.1	1x14	97	51	32	30
1J977-12-12	19	3/4	-12	19.1	1 3/16x12	108	62	48	36
1J977-16-12	19	3/4	-12	19.1	1 7/16x12	108	62	56	41
1J977-16-16	25	1	-16	25.4	1 7/16x12	131	77	56	41
1J977-20-20	31	1 1/4	-20	31.8	1 11/16x12	146	82	64	50
1J977-24-24	38	1 1/2	-24	38.1	2x12	163	96	69	60

J1 Female ORFS – Swivel 90° Elbow – Long Drop

ISO 12151-1 – SWEL
SAE J 516 – ORFS 90° L

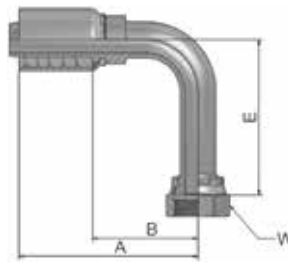

Part Number	Hose I.D.				Thread UNF	A mm	B mm	E mm	W mm
	DN	Inch	Size	mm					
1J177-12-12	19	3/4	-12	19.1	1 3/16x12	108	62	96	36
1J177-16-16	25	1	-16	25.4	1 7/16x12	131	77	114	41

Approved **fitting series** for **hose types**, depending on size:

77	387	387ST	387TC	487	487ST	487TC	787	787TC	787ST	797	797TC	797ST	797RH	SX42 ...
SX42LT SX42TC														

JM

ORFS Male

ISO 12151-1-S – SAE J516

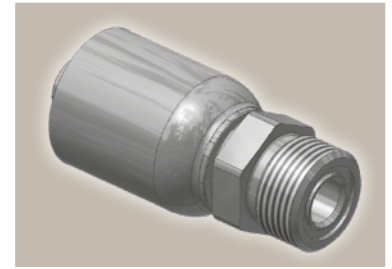
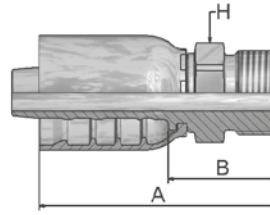

Part Number	Hose I.D.				Thread UNF	A mm	B mm	H mm
	DN	Inch	Size	mm				
1JM77-8-8	12	1/2	-8	12.7	13/16x16	66	32	22
1JM77-12-8	12	1/2	-8	12.7	1 3/16x12	75	40	32
1JM77-10-10	16	5/8	-10	15.9	1x14	76	37	27
1JM77-12-10	16	5/8	-10	15.9	1 3/16x12	79	40	32
1JM77-12-12	19	3/4	-12	19.1	1 3/16x12	89	43	32
1JM77-16-12	19	3/4	-12	19.1	1 7/16x12	93	47	41
1JM77-16-16	25	1	-16	25.4	1 7/16x12	96	40.9	41
1JM77-20-16	25	1	-16	25.4	1 11/16x12	93	39.2	46
1JM77-20-20	31	1 1/4	-20	31.8	1 11/16x12	110	46	46
1JM77-24-20	31	1 1/4	-20	31.8	2 12	116	52	55

JM fittings are supplied without O-ring.
Find O-rings in section E. Special O-rings are available on request.

77 Series

Approved **fitting series** for **hose types**, depending on size:

77	387	387ST	387TC	487	487ST	487TC	787	787TC	787ST	797	797TC	797ST	797RH	SX42	...
	SX42LT	SX42TC													

FG Male French Gas Series
Rigid – Straight (24° Cone)

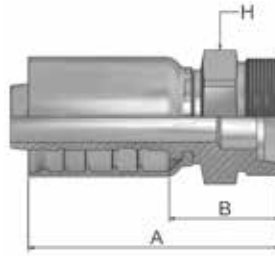

Part Number	Hose I.D.				Thread metric	A mm	B mm	H mm
	DN	Inch	Size	mm				
1FG77-27-12	19	3/4	-12	19.1	M36x1.5	82	36	36
1FG77-33-16	25	1	-16	25.4	M45x1.5	97	43	46

Approved **fitting series** for **hose types**, depending on size:

77	387	387ST	387TC	487	487ST	487TC	787	787TC	787ST	797	797TC	797ST	797RH	SX42	...
	SX42LT	SX42TC													

Large range of special hose fittings for the MRO market

The demand for special hose fittings is part of our everyday business.

In order to meet this demand with the authority expected, the Hose Products Division Europe has extended its standard offer with special hose fittings such as an extra drop length, etc.

The following is an overview of our special hose fitting selection:

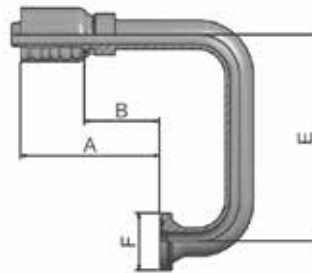

Further special hose fittings are available on request.

Part Number	Description	Hose I.D. Size	Flange Inch	A mm	B mm	E mm	F mm
11977-12-12-SL100	SAE 5000 psi 90° elbow - drop length 100 mm	-12	3/4	108	62	100	38
11977-12-12-SL150	SAE 5000 psi 90° elbow - drop length 150 mm	-12	3/4	108	62	150	38
11977-16-12-SL100	SAE 5000 psi 90° elbow - drop length 100 mm	-12	1	108	62	100	45
11977-16-12-SL150	SAE 5000 psi 90° elbow - drop length 150 mm	-12	1	108	62	150	45
11977-16-16-SL150	SAE 5000 psi 90° elbow - drop length 150 mm	-16	1	131	77	150	45
14N77-24-24-SL150	SAE 5000 psi 90° elbow - drop length 150 mm	-24	1 1/2	175	108	150	60
16A77-20-20-RL186	SAE 6000 psi - straight - Special	-20	1 1/4	175	112		54
16F77-12-16-STB10	SAE 6000 psi - 10° elbow	-16	3/4	143	89	6	41
16F77-20-16-RL110	SAE 6000 psi - 45° elbow - Special	-16	1 1/4	164	110	32	54
16N77-12-12-SL100	SAE 6000 psi 90° elbow - drop length 100 mm	-12	3/4	108	62	100	41
16N77-12-12-SL230	SAE 6000 psi 90° elbow - drop length 230 mm	-12	3/4	108	62	230	41
16N77-12-12-SL72	SAE 6000 psi 90° elbow - drop length 72 mm	-12	3/4	108	62	72	41
16N77-12-12-SL85	SAE 6000 psi 90° elbow - drop length 85 mm	-12	3/4	108	62	85	41
16N77-12-12-STB115	SAE 6000 psi - 115° elbow	-12	3/4	116	70	72	41
16N77-12-12-STB180	SAE 6000 psi - 180° elbow	-12	3/4	101	55	150	41
16N77-12-16-SL55	SAE 6000 psi 90° elbow - drop length 85 mm	-16	3/4	118	64	55	41
16N77-12-16-SL95	SAE 6000 psi 90° elbow - drop length 95 mm	-16	3/4	118	64	95	41
16N77-16-16-SL100	SAE 6000 psi 90° elbow - drop length 100 mm	-16	1	131	77	100	48
16N77-16-16-SL110	SAE 6000 psi 90° elbow - drop length 110 mm	-16	1	131	77	110	48
16N77-16-16-SL120	SAE 6000 psi 90° elbow - drop length 120 mm	-16	1	131	77	120	48
16N77-16-16-SL150	SAE 6000 psi 90° elbow - drop length 150 mm	-16	1	131	77	150	48
16N77-16-16-SL175	SAE 6000 psi 90° elbow - drop length 175 mm	-16	1	135	81	175	48
16N77-16-16-STB120	SAE 6000 psi 120° elbow	-16	1	110	56	85	48
16N77-16-16-STB63-SL75	SAE 6000 psi 63° elbow - drop length 75 mm	-16	1	167	113	75	48
16N77-20-16-SL120	SAE 6000 psi 90° elbow - drop length 120 mm	-16	1 1/4	135	81	120	54
16N77-20-16-SL130	SAE 6000 psi 90° elbow - drop length 130 mm	-16	1 1/4	135	81	130	54
16N77-20-16-STB110-SL150	SAE 6000 psi 110° elbow - drop length 150 mm	-16	1 1/4	128	74	150	54
16N77-20-16-STB70-SL70	SAE 6000 psi 70° elbow - drop length 70 mm	-16	1 1/4	157	103	70	54
16N77-20-20-SL115-RL220	SAE 6000 psi 90° elbow - drop length 220 mm	-20	1 1/4	220	156	115	54
16N77-20-20-SL120	SAE 6000 psi 90° elbow - drop length 120 mm	-20	1 1/4	151	87	120	54
16N77-20-20-SL150-RL150	SAE 6000 psi 90° elbow - drop length 150 mm	-20	1 1/4	238	175	150	54
16N77-20-20-SL150-RL220	SAE 6000 psi 90° elbow - drop length 150 mm	-20	1 1/4	220	156	150	54
16N77-20-20-SL195-RL320	SAE 6000 psi 90° elbow - drop length 195 mm	-20	1 1/4	320	256	195	54
16N77-20-20-SL230-RL250	SAE 6000 psi 90° elbow - drop length 230 mm	-20	1 1/4	338	275	230	54
16N77-20-20-SL230-RL320	SAE 6000 psi 90° elbow - drop length 230 mm	-20	1 1/4	320	256	230	54
16377-16-16	SAE 6000 psi 135° elbow	-16	1	122	68	88	48
16377-20-20	SAE 6000 psi 135° elbow	-20	1 1/4	132	69	109	54
16377-24-24	SAE 6000 psi 135° elbow	-24	1 1/2	124	57	129	64

Approved **fitting series** for **hose types**, depending on size:

77	387	387ST	387TC	487	487ST	487TC	787	787TC	787ST	797	797TC	797ST	797RH	SX42	...
	SX42LT		SX42TC												

Shell

Page De-1

VS

De-1



Interlock
Outside Skive

DIN – Metric

Page De-2 – De-5

CA

De-2



Female Metric 24°
Light Series with O-Ring
Swivel – Straight
ISO 12151-2-SWS-L – DKOL

CE

De-2

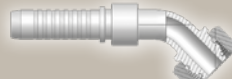

Female Metric 24°
Light Series with O-Ring
Swivel – 45° Elbow
ISO 12151-2-SWE-L – DKOL 45°

CF

De-3

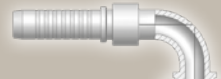

Female Metric 24°
Light Series with O-Ring
Swivel – 90° Elbow
ISO 12151-2-SWE-L – DKOL 90°

D0

De-3



Male Metric 24°
Light Series – Rigid
Straight
ISO 12151-2-S-L – CEL

C9

De-4

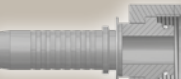

Female Metric 24° – Swivel
Heavy Series with O-Ring
Straight
ISO 12151-2-SWS-S – DKOS

OC

De-4

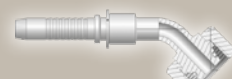

Female Metric 24° – Swivel
Heavy Series with O-Ring
45° Elbow
ISO 12151-2-SWE-S – DKOS 45°

1C

De-5

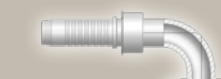

Female Metric 24° – Swivel
Heavy Series with O-Ring
90° Elbow
ISO 12151-2-SWE-S – DKOS 90°

D2

De-5



Male Metric 24° – Rigid
Heavy Series – Straight
ISO 12151-2-S-S – CES

BSP

Page De-6 – De-7

92

De-6

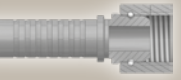

Female BSP Parallel Pipe
Swivel – Straight (60° Cone)
BS5200-A – DKR

B1

De-6



Female BSP Parallel Pipe
Swivel
45° Elbow (60° Cone)
BS 5200-D – DKR 45°

B2

De-7

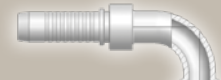

Female BSP Parallel Pipe
Swivel
90° Elbow (60° Cone)
BS 5200-B – DKR 90°

D9

De-7

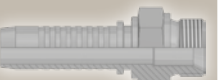

Male BSP Parallel Pipe
Rigid – Straight (60° Cone)
BS5200 – AGR

SAE

Page De-8 – De-10

01

De-8



Male NPTF Pipe
Rigid – Straight
SAE J476A / J516 – AGN

03

De-8



Male JIC 37° – Rigid
Straight
ISO12151-5-S – AGJ

06/68

De-9



Female – JIC 37°
SAE 45° Dual Flare
Swivel – Straight
ISO12151-5-SWS – DKJ

37/3V

De-9

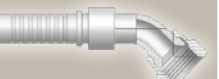

Female JIC 37°
SAE 45° – Dual Flare
Swivel Female 45° Elbow
ISO 12151-5-SWE 45° – DKJ 45°

39/3W

De-10

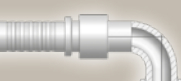

Female JIC 37°
SAE 45° – Dual Flare
Swivel Female 90° Elbow
ISO 12151-5-SWES – DKJ 90°

Flange

Page De-11 – De-13

15

De-11



**ISO 6162-1-Flange
Straight**
ISO 12151-3-S-L – SFL
(21.0 MPa/ 3000 psi)

17

De-11



**ISO 6162-1 Flange
45° Elbow**
ISO 12151-3 – E45 – L – SFL 45°
(21.0 MPa/ 3000 psi)

19

De-12



**ISO 6162-1-Flange
90° Elbow**
ISO 12151-3 – E – L – SFL 90°
(21.0 MPa/ 3000 psi)

6A

De-12

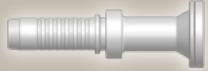

**ISO 6162-2-Flange
Straight**
ISO 12151-3-S-S – SFS
(42.0 MPa/ 6000 psi)

6F

De-13



**ISO 6162-2-Flange
45° Elbow – Heavy Series**
ISO 12151-3 – E45-S – SFS 45°
(42.0 MPa/ 6000 psi)

6N

De-13



**ISO 6162-2-Flange
90° Elbow**
ISO 12151-3 – E-S – SFS 90°
(42.0 MPa/ 6000 psi)

ORFS

Page De-14 – De-15

JC

De-14



**Female ORFS
Swivel – Straight
Short**
ISO 12151-1 – SWSA SAE J516 – ORFS

J7

De-14



**Female ORFS – Swivel
45° Elbow**
ISO 12151-1 – SWE 45°
SAE J516 – ORFS 45°

J9

De-15



**Female ORFS – Swivel
90° Elbow – Short Drop**
ISO 12151-1 – SWES
SAE J516 – ORFS 90°

VS

**Interlock
Outside Skive**



**Only for use with
adjustable crimpers.**

Part Number	 Hose I.D.				B mm
	DN	Inch	Size	mm	
100VS-4	6	1/4	-4	6.4	38
100VS-6	10	3/8	-6	9.5	36
100VS-8	12	1/2	-8	12.7	41

Approved **fitting series** for hose types, depending on size:

VS H31 | H31TC | H31ST | FA35

CA **Female Metric 24°
Light Series with O-Ring
Swivel – Straight**
ISO 12151-2-SWS-L – DKOL

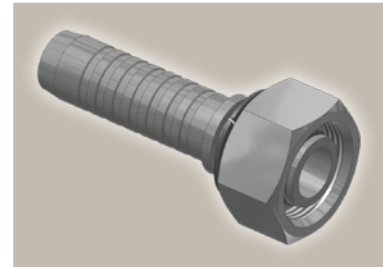
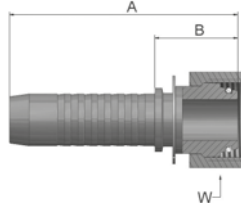

Part Number	Hose I.D.				Thread metric	Tube O.D. mm	A mm	B mm	W mm
	DN	Inch	Size	mm					
KCAVS-10-6	10	3/8	-6	9.5	M16x1.5	10	65	26	19
KCAVS-12-6	10	3/8	-6	9.5	M18x1.5	12	62	23	22
KCAVS-15-8	12	1/2	-8	12.7	M22x1.5	15	70	27	27

Fittings with standard O-ring seals can be used for temperatures from -40 °C up to +105 °C.
O-rings see section Eb. Special O-rings are available on request.

CE **Female Metric 24°
Light Series with O-Ring
Swivel – 45° Elbow**
ISO 12151-2-SWE -L – DKOL 45°

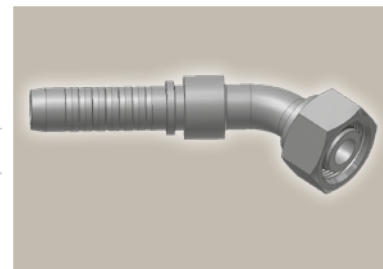
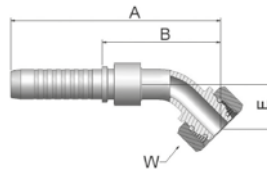

Part Number	Hose I.D.				Thread metric	Tube O.D. mm	A mm	B mm	E mm	W mm
	DN	Inch	Size	mm						
KCEVS-12-6	10	3/8	-6	9.5	M18x1.5	12	94	55	20	22
KCEVS-15-8	12	1/2	-8	12.7	M22x1.5	15	104	62	24	27

Fittings with standard O-ring seals can be used for temperatures from -40 °C up to +105 °C.
O-rings see section Eb. Special O-rings are available on request.

Approved **fitting series** for hose types, depending on size:

VS H31 | H31TC | H31ST | FA35

CF **Female Metric 24°
Light Series with O-Ring
Swivel – 90° Elbow**
ISO 12151-2-SWE-L – DKOL 90°

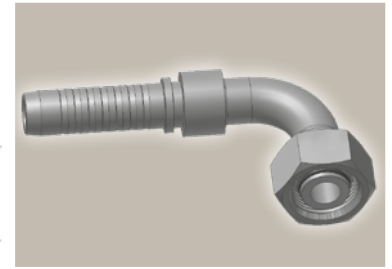
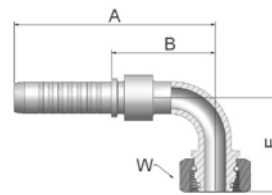

Part Number	Hose I.D.				Thread metric	Tube O.D. mm	A mm	B mm	E mm	W mm
	DN	Inch	Size	mm						
KCFVS-12-6	10	3/8	-6	9.5	M18x1.5	12	83	45	36	22
KCFVS-15-8	12	1/2	-8	12.7	M22x1.5	15	92	50	45	27

Fittings with standard O-ring seals can be used for temperatures from -40 °C up to +105 °C.
O-rings see section Eb. Special O-rings are available on request.

DO **Male Metric 24°
Light Series – Rigid
Straight**
ISO 12151-2-S-L – CEL

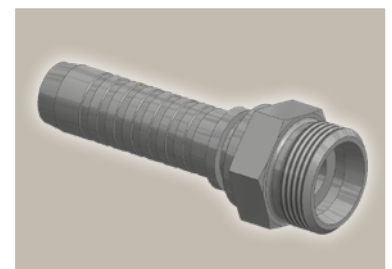
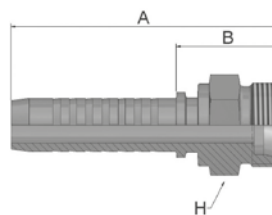

Part Number	Hose I.D.				Thread metric	Tube O.D. mm	A mm	B mm	H mm
	DN	Inch	Size	mm					
KDOVS-12-6	10	3/8	-6	9.5	M18x1.5	12	64	25	19
KDOVS-15-8	12	1/2	-8	12.7	M22x1.5	15	71	28	22

Approved **fitting series** for hose types, depending on size:

VS H31 | H31TC | H31ST | FA35

C9 Female Metric 24° – Swivel Heavy Series with O-Ring Straight

ISO 12151-2-SWS-S – DKOS

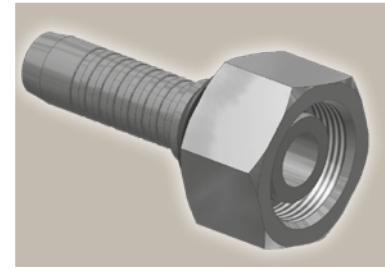
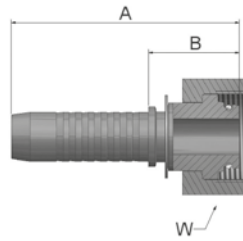

Part Number	Hose I.D.				Thread metric	Tube O.D. mm	A mm	B mm	W mm
	DN	Inch	Size	mm					
KC9VS-8-4	6	1/4	-4	6.4	M16x1.5	8	61	23	19
KC9VS-10-4	6	1/4	-4	6.4	M18x1.5	10	62	24	22
KC9VS-8-6	10	3/8	-6	9.5	M16x1.5	8	64	25	19
KC9VS-12-6	10	3/8	-6	9.5	M20x1.5	12	63	25	24
KC9VS-14-6	10	3/8	-6	9.5	M22x1.5	14	63	24	27
KC9VS-16-8	12	1/2	-8	12.7	M24x1.5	16	71	29	30
KC9VS-20-8	12	1/2	-8	12.7	M30x2	20	71	29	36

Fittings with standard O-ring seals can be used for temperatures from -40 °C up to +105 °C.
O-rings see section Eb. Special O-rings are available on request.

OC Female Metric 24° – Swivel Heavy Series with O-Ring 45° Elbow

ISO 12151-2 – SWE -S – DKOS 45°

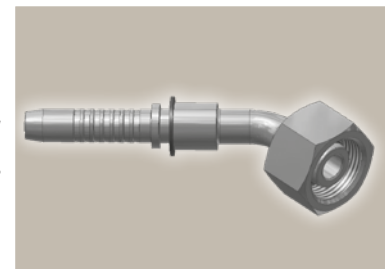
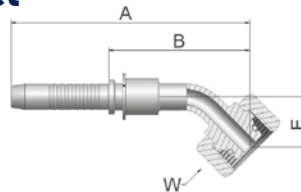

Part Number	Hose I.D.				Thread metric	Tube O.D. mm	A mm	B mm	E mm	W mm
	DN	Inch	Size	mm						
KOCVS-8-4	6	1/4	-4	6.4	M16x1.5	8	88	50	16	19
KOCVS-10-4	6	1/4	-4	6.4	M18x1.5	10	88	50	16	22
KOCVS-12-6	10	3/8	-6	9.5	M20x1.5	12	94	56	20	24
KOCVS-14-6	10	3/8	-6	9.5	M22x1.5	14	94	56	20	27
KOCVS-16-8	12	1/2	-8	12.7	M24x1.5	16	105	62	24	30

Fittings with standard O-ring seals can be used for temperatures from -40 °C up to +105 °C.
O-rings see section Eb. Special O-rings are available on request.

Approved **fitting series** for hose types, depending on size:

VS H31 H31TC H31ST FA35

1C Female Metric 24° – Swivel Heavy Series with O-Ring 90° Elbow

ISO 12151-2-SWE-S – DKOS 90°

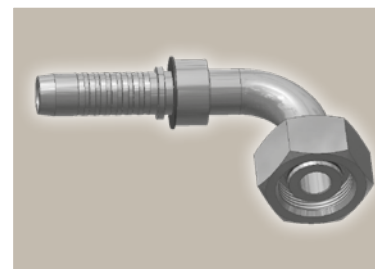
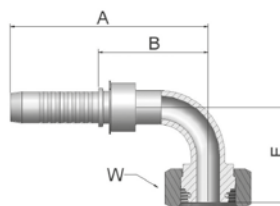

Part Number	Hose I.D.				Thread metric	Tube O.D. mm	A mm	B mm	E mm	W mm
	DN	Inch	Size	mm						
K1CVS-8-4	6	1/4	-4	6.4	M16x1.5	8	79	41	29	19
K1CVS-10-4	6	1/4	-4	6.4	M18x1.5	10	79	41	29	22
K1CVS-12-6	10	3/8	-6	9.5	M20x1.5	12	83	45	37	24
K1CVS-14-6	10	3/8	-6	9.5	M22x1.5	12	83	45	37	27
K1CVS-16-8	12	1/2	-8	12.7	M24x1.5	16	93	51	45	30

Fittings with standard O-ring seals can be used for temperatures from -40 °C up to +105 °C. O-rings see section Eb. Special O-rings are available on request.

D2 Male Metric 24° – Rigid Heavy Series – Straight

ISO 12151-2-S-S – CES

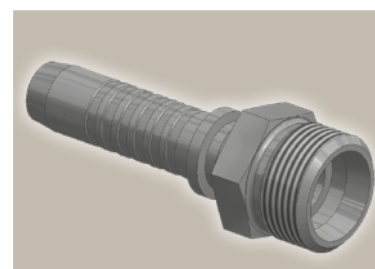
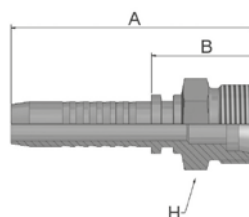

Part Number	Hose I.D.				Thread metric	Tube O.D. mm	A mm	B mm	H mm
	DN	Inch	Size	mm					
KD2VS-12-6	10	3/8	-6	9.5	M20x1.5	12	66	27	22
KD2VS-14-6	10	3/8	-6	9.5	M22x1.5	14	68	30	22
KD2VS-16-8	12	1/2	-8	12.7	M24x1.5	16	74	31	24

Approved **fitting series** for hose types, depending on size:

VS H31 | H31TC | H31ST | FA35

92 Female BSP Parallel Pipe Swivel – Straight (60° Cone)

BS5200-A – DKR

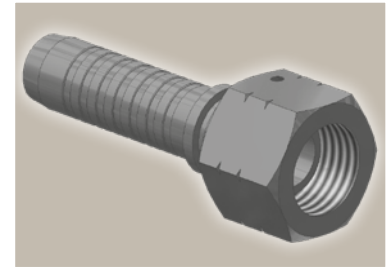
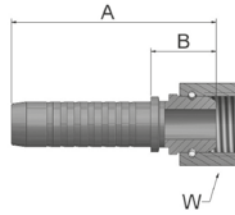

Part Number	Hose I.D.				Thread BSP	A mm	B mm	W mm
	DN	Inch	Size	mm				
K92VS-6-6	10	3/8	-6	9.5	3/8x19	60	22	22
K92VS-8-6	10	3/8	-6	9.5	1/2x14	62	23	27
K92VS-8-8	12	1/2	-8	12.7	1/2x14	67	24	27
K92VS-10-8	12	1/2	-8	12.7	5/8x14	65	23	30

B1 Female BSP Parallel Pipe Swivel 45° Elbow (60° Cone)

BS 5200-D – DKR 45°

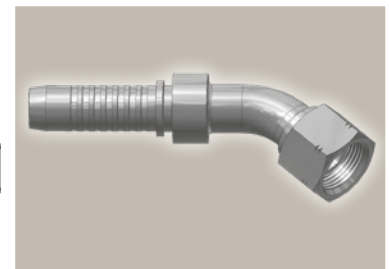
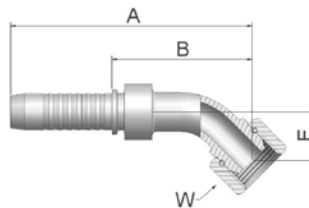

Part Number	Hose I.D.				Thread BSP	A mm	B mm	E mm	W mm
	DN	Inch	Size	mm					
KB1VS-6-6	10	3/8	-6	9.5	3/8x19	90	52	17	22
KB1VS-8-8	12	1/2	-8	12.7	1/2x14	100	58	20	27
KB1VS-10-8	12	1/2	-8	12.7	5/8x14	99	57	19	30

Approved **fitting series** for hose types, depending on size:

VS H31 H31TC H31ST FA35

B2 Female BSP Parallel Pipe Swivel 90° Elbow (60° Cone)

BS 5200-B – DKR 90°

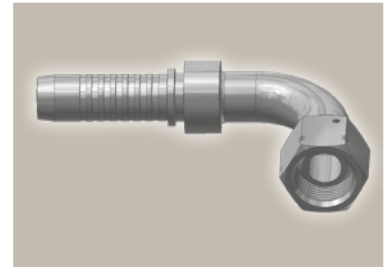
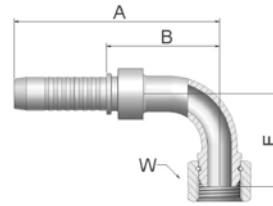

Part Number	Hose I.D.				Thread BSP	A mm	B mm	E mm	W mm
	DN	Inch	Size	mm					
KB2VS-6-6	10	3/8	-6	9.5	3/8x19	82	44	33	22
KB2VS-8-6	10	3/8	-6	9.5	1/2x14	83	45	36	27
KB2VS-8-8	12	1/2	-8	12.7	1/2x14	92	50	40	27
KB2VS-10-8	12	1/2	-8	12.7	5/8x14	92	50	38	30

D9 Male BSP Parallel Pipe Rigid – Straight (60° Cone)

BS5200 – AGR

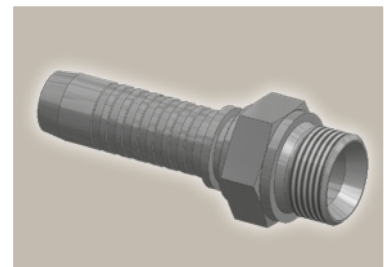
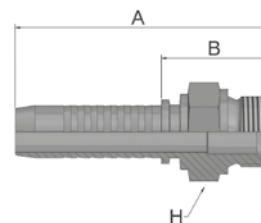

Part Number	Hose I.D.				Thread BSP	A mm	B mm	H mm
	DN	Inch	Size	mm				
KD9VS-4-4	6	1/4	-4	6.4	1/4x19	67	28	19
KD9VS-6-6	10	3/8	-6	9.5	3/8x19	71	33	22
KD9VS-8-8	12	1/2	-8	12.7	1/2x14	78	36	27

Approved **fitting series** for **hose types**, depending on size:

VS H31 | H31TC | H31ST | FA35

01 Male NPTF Pipe Rigid – Straight

SAE J476A / J516 – AGN

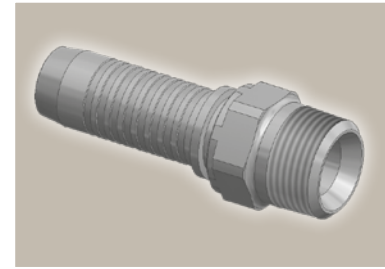
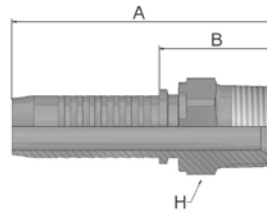

Part Number	Hose I.D.				Thread NPTF	A mm	B mm	H mm
	DN	Inch	Size	mm				
K01VS-6-6	10	3/8	-6	9.5	3/8-18	71	33	19
K01VS-8-8	12	1/2	-8	12.7	1/2-14	83	40	22

03 Male JIC 37° – Rigid Straight

ISO12151-5-S – AGJ

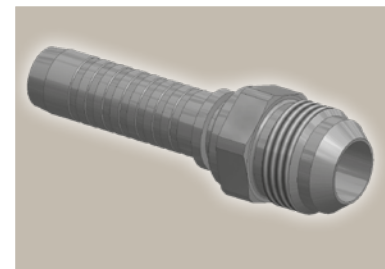
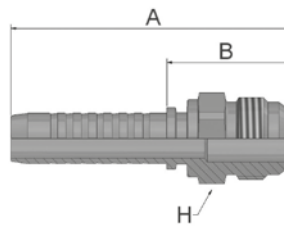

Part Number	Hose I.D.				Thread UNF	A mm	B mm	H mm
	DN	Inch	Size	mm				
K03VS-6-6	10	3/8	-6	9.5	9/16x18	71	32	19
K03VS-8-6	10	3/8	-6	9.5	3/4x16	69	31	22
K03VS-8-8	12	1/2	-8	12.7	3/4x16	79	36	22
K03VS-10-8	12	1/2	-8	12.7	7/8x14	77	35	24

Approved **fitting series** for hose types, depending on size:

VS H31 | H31TC | H31ST | FA35

06/68 Female – JIC 37°
SAE 45° Dual Flare
Swivel – Straight
ISO12151-5-SWS – DKJ

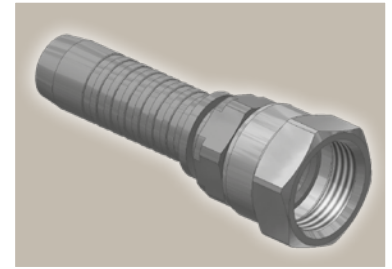
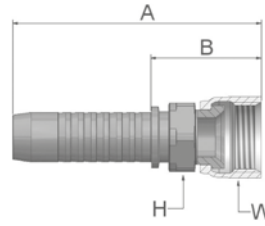

Part Number	Hose I.D.				Thread UNF	A mm	B mm	H mm	W mm
	DN	Inch	Size	mm					
K68VS-4-4	6	1/4	-4	6.4	7/16 20	66	28	14	17
K06VS-6-6	10	3/8	-6	9.5	9/16x18	69	31	17	19
K68VS-8-6	10	3/8	-6	9.5	3/4x16	74	35	17	22
K68VS-8-8	12	1/2	-8	12.7	3/4x16	77	35	22	22
K68VS-10-8	12	1/2	-8	12.7	7/8x14	83	41	22	27
K06VS-12-8	12	1/2	-8	12.7	1 1/16x12	83	41	27	32

37/3V Female JIC 37°
SAE 45° – Dual Flare
Swivel Female 45° Elbow
ISO 12151-5-SWE 45° – DKJ 45°

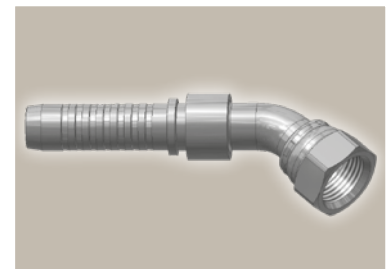
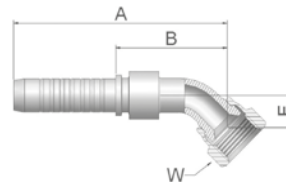





Part Number	Hose I.D.				Thread UNF	A mm	B mm	E mm	W mm
	DN	Inch	Size	mm					
K37VS-6-6	10	3/8	-6	9.5	9/16x18	83	45	11	19
K3VVS-8-6	10	3/8	-6	9.5	3/4x16	87	49	15	22
K3VVS-8-8	12	1/2	-8	12.7	3/4x16	93	51	15	22
K3VVS-10-8	12	1/2	-8	12.7	7/8x14	94	52	16	27
K37VS-12-8	12	1/2	-8	12.7	1 1/16x12	99	57	21	32

Approved **fitting series** for hose types, depending on size:

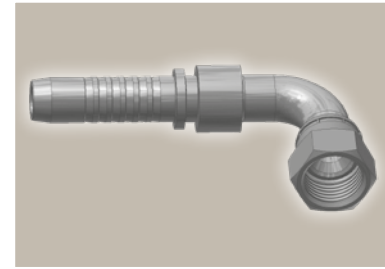
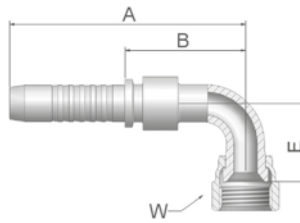
VS H31 | H31TC | H31ST | FA35

39/3W Female JIC 37°
SAE 45° – Dual Flare
Swivel Female 90° Elbow
 ISO 12151-5-SWES – DKJ 90°



Part Number	 Hose I.D.				 Thread UNF	A mm	B mm	E mm	 W mm
	DN	Inch	Size	mm					
K39VS-6-6	10	3/8	-6	9.5	9/16x18	80	42	23	19
K3WVS-8-6	10	3/8	-6	9.5	3/4x16	80	42	29	22
K3WVS-8-8	12	1/2	-8	12.7	3/4x16	87	45	29	22
K3WVS-10-8	12	1/2	-8	12.7	7/8x14	87	45	32	27

Approved **fitting series** for **hose types**, depending on size:

VS H31 | H31TC | H31ST | FA35

15 ISO 6162-1-Flange Straight

ISO 12151-3-S-L – SFL
(21.0 MPa/ 3000 psi)

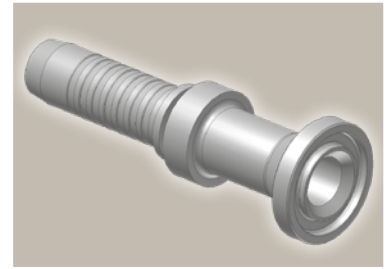
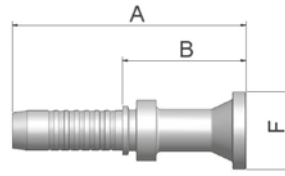

Part Number	Hose I.D.				Flange Inch	A mm	B mm	F mm
	DN	Inch	Size	mm				
K15VS-8-8	12	1/2	-8	12.7	1/2	102	59	30
K15VS-12-8	12	1/2	-8	12.7	3/4	77	34	38

SAE flange halves see in section Eb.

17 ISO 6162-1 Flange 45° Elbow

ISO 12151-3 – E45 – L – SFL 45°
(21.0 MPa/ 3000 psi)

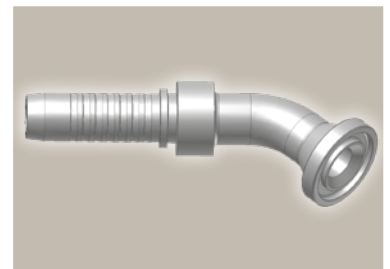
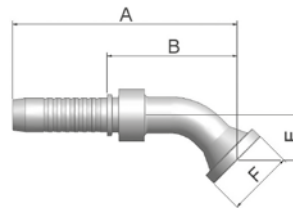

Part Number	Hose I.D.				Flange Inch	A mm	B mm	E mm	F mm
	DN	Inch	Size	mm					
K17VS-8-8	12	1/2	-8	12.7	1/2	100	57	20	30
K17VS-12-8	12	1/2	-8	12.7	3/4	101	58	21	38

SAE flange halves see in section Eb.



Approved **fitting series** for hose types, depending on size:

VS H31 | H31TC | H31ST | FA35

19 ISO 6162-1-Flange 90° Elbow

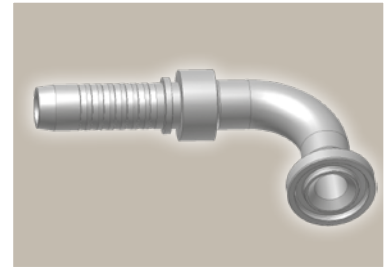
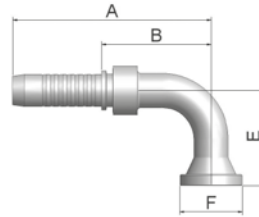
ISO 12151-3 – E- L – SFL 90°
(21.0 MPa/ 3000 psi)





Part Number	 Hose I.D.				 Flange	A	B	E	F
	DN	Inch	Size	mm	Inch	mm	mm	mm	mm
K19VS-8-8	12	1/2	-8	12.7	1/2	92	50	41	30
K19VS-12-8	12	1/2	-8	12.7	3/4	92	50	42	38

SAE flange halves see in section Eb.

6A ISO 6162-2-Flange Straight

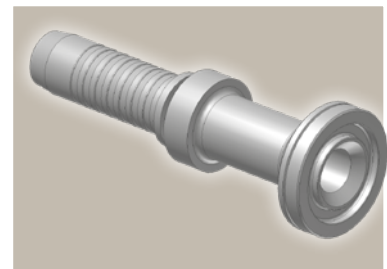
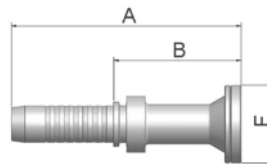
ISO 12151-3-S-S – SFS
(42.0 MPa/ 6000 psi)



Part Number	 Hose I.D.				 Flange	A	B	F
	DN	Inch	Size	mm	Inch	mm	mm	mm
K6AVS-8-8	12	1/2	-8	12.7	1/2	105	63	32
K6AVS-12-8	12	1/2	-8	12.7	3/4	79	36	41

SAE flange halves see in section Eb.

Approved **fitting series** for **hose types**, depending on size:

VS H31 | H31TC | H31ST | FA35

6F

ISO 6162-2-Flange 45° Elbow – Heavy Series

ISO 12151-3 – E45-S – SFS 45°
(42.0 MPa/ 6000 psi)

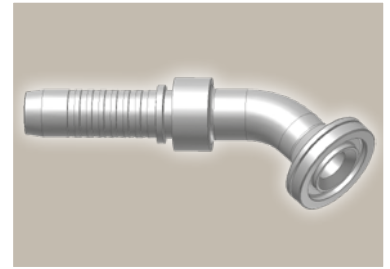
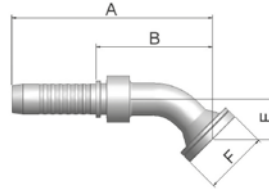

Part Number	Hose I.D.				Flange Inch	A mm	B mm	E mm	F mm
	DN	Inch	Size	mm					
K6FVS-8-8	12	1/2	-8	12.7	1/2	94	52	19	32
K6FVS-12-8	12	1/2	-8	12.7	3/4	106	64	26	41

SAE flange halves see in section Eb.

6N

ISO 6162-2-Flange 90° Elbow

ISO 12151-3 – E-S – SFS 90°
(42.0 MPa/ 6000 psi)

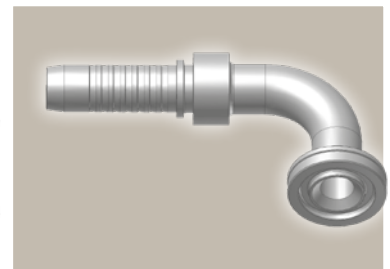
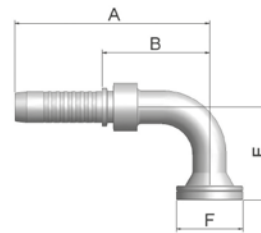

Part Number	Hose I.D.				Flange Inch	A mm	B mm	E mm	F mm
	DN	Inch	Size	mm					
K6NVS-8-8	12	1/2	-8	12.7	1/2	87	45	41	32
K6NVS-12-8	12	1/2	-8	12.7	3/4	92	50	45	41

SAE flange halves see in section Eb.

Approved **fitting series** for hose types, depending on size:

VS H31 | H31TC | H31ST | FA35

JC Female ORFS Swivel – Straight Short

ISO 12151-1 – SWSA
SAE J516 – ORFS

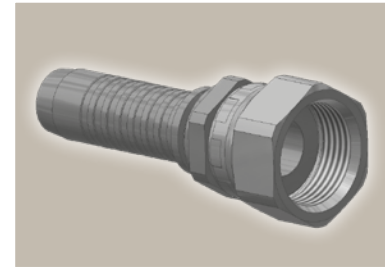
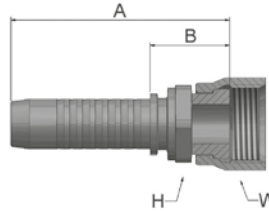

Part Number	Hose I.D.				Thread UNF	A mm	B mm	H mm	W mm
	DN	Inch	Size	mm					
KJCVS-6-6	10	3/8	-6	9.5	11/16x16	60	22	17	22
KJCVS-8-6	10	3/8	-6	9.5	13/16x16	62	23	19	24
KJCVS-8-8	12	1/2	-8	12.7	13/16x16	67	24	22	24
KJCVS-10-8	12	1/2	-8	12.7	1x14	69	26	24	30

J7 Female ORFS – Swivel 45° Elbow

ISO 12151-1 – SWE 45°
SAE J516 – ORFS 45°

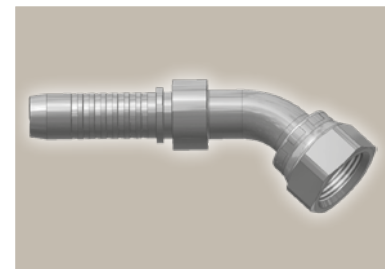
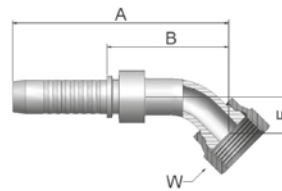

Part Number	Hose I.D.				Thread UNF	A mm	B mm	E mm	W mm
	DN	Inch	Size	mm					
KJ7VS-6-6	10	3/8	-6	9.5	11/16x16	83	45	11	22
KJ7VS-8-6	10	3/8	-6	9.5	13/16x16	89	51	15	24
KJ7VS-8-8	12	1/2	-8	12.7	13/16x16	93	51	15	24
KJ7VS-10-8	12	1/2	-8	12.7	1x14	96	53	16	30

Approved **fitting series** for hose types, depending on size:

VS H31 H31TC H31ST FA35

J9

Female ORFS – Swivel 90° Elbow – Short Drop

ISO 12151-1 – SWES
SAE J516 – ORFS 90°

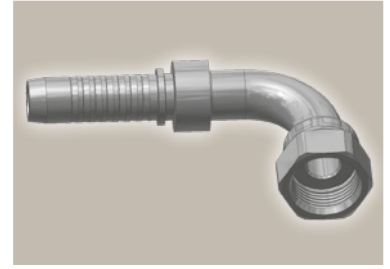
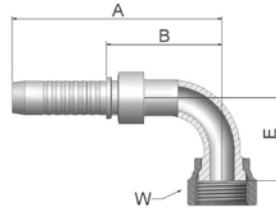

Part Number	Hose I.D.				Thread UNF	A mm	B mm	E mm	W mm
	DN	Inch	Size	mm					
KJ9VS-6-6	10	3/8	-6	9.5	11/16x16	80	42	23	22
KJ9VS-8-6	10	3/8	-6	9.5	13/16x16	83	45	29	24
KJ9VS-8-8	12	1/2	-8	12.7	13/16x16	87	45	29	24
KJ9VS-10-8	12	1/2	-8	12.7	1x14	88	46	30	30

Approved **fitting series** for **hose types**, depending on size:

VS H31 | H31TC | H31ST | FA35

Shell

Page Df-1

V4

Df-1

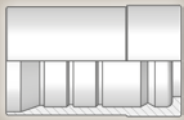

**Interlock
In-/Outside Skive**
4 Wire Hoses

V6

Df-1

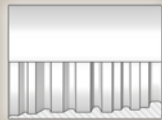

**Interlock
In-/Outside Skive**
6 Wire Hoses

DIN – Metric

Page Df-2 – Df-5

CA

Df-2

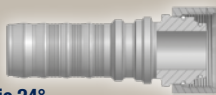

**Female Metric 24°
Light Series with O-Ring
Swivel – Straight**
ISO 12151-2-SWS-L – DKOL

CE

Df-2

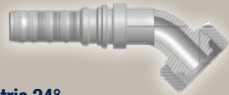

**Female Metric 24°
Light Series with O-Ring
Swivel – 45° Elbow**
ISO 12151-2-SWE-L – DKOL 45°

CF

Df-3

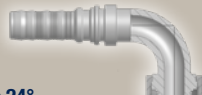

**Female Metric 24°
Light Series with O-Ring
Swivel – 90° Elbow**
ISO 12151-2-SWE-L – DKOL 90°

C9

Df-3



**Female Metric 24° – Swivel
Heavy Series with O-Ring
Straight**
ISO 12151-2-SWS-S – DKOS

OC

Df-4



**Female Metric 24° – Swivel
Heavy Series with O-Ring
45° Elbow**
ISO 12151-2 – SWE -S – DKOS 45°

1C

Df-4



**Female Metric 24° – Swivel
Heavy Series with O-Ring
90° Elbow**
ISO 12151-2-SWE-S – DKOS 90°

D2

Df-5

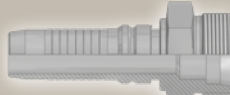

**Male Metric 24° – Rigid
Heavy Series – Straight**
ISO 12151-2-S-S – CES

BSP

Page Df-6 – Df-8

92

Df-6

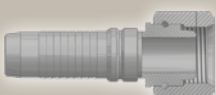

**Female BSP Parallel Pipe
Swivel – Straight (60° Cone)**
BS5200-A – DKR

B1

Df-6



**Female BSP Parallel Pipe
Swivel
45° Elbow (60° Cone)**
BS 5200-D – DKR 45°

B2

Df-7



**Female BSP Parallel Pipe
Swivel
90° Elbow (60° Cone)**
BS 5200-B – DKR 90°

D9

Df-7

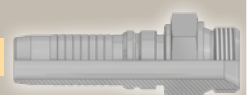

**Male BSP Parallel Pipe
Rigid – Straight (60° Cone)**
BS5200 – AGR

91

Df-8

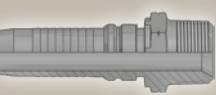

**Male BSP Taper Pipe – Rigid
Straight**
BS5200 – AGR-K

SAE

Page Df-9 – Df-11

01

Df-9

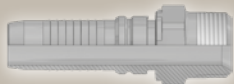

**Male NPTF Pipe
Rigid – Straight**
SAE J476A / J516 – AGN

03

Df-9

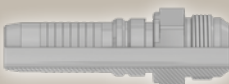

**Male JIC 37° – Rigid
Straight**
ISO12151-5-S – AGJ

06

Df-10

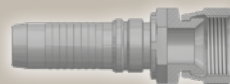

**Female JIC 37° – Swivel
Straight**
ISO12151-5-SWS – DKJ

37

Df-10

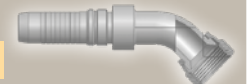

**Female JIC 37° – Swivel
45° Elbow**
ISO 12151-5-SWE 45° – DKJ 45°

39

Df-11



**Female JIC 37° – Swivel
90° Elbow**
ISO 12151-5-SWES – DKJ 90°



Flange

Page Df-12 – Df-22

<p>15/4A Df-12 ISO 6162-1-Flange Straight ISO 12151-3-S-L – SFL (35.0 MPa/ 5000 psi)</p> 	<p>17/4F Df-13 ISO 6162-1-Flange 45° Elbow ISO 12151-3 – E45S – L – SFL 45° (35.0 MPa/ 5000 psi)</p> 	<p>19/4N Df-14 ISO 6162-1-Flange 90° Elbow ISO 12151-3-E-L – SFL 90° (35.0 MPa/ 5000 psi)</p> 	<p>6A Df-15 ISO 6162-2-Flange Straight ISO 12151-3-S-S – SFS (42.0 MPa/ 6000 psi)</p> 
<p>6F Df-16 ISO 6162-2-Flange 45° Elbow – Heavy Series ISO 12151-3 – E45-S – SFS 45° (42.0 MPa/ 6000 psi)</p> 	<p>6N Df-17 ISO 6162-2-Flange 90° Elbow ISO 12151-3 – E-S – SFS 90° (42.0 MPa/ 6000 psi)</p> 	<p>8A Df-18 Flange – Straight 8000 psi</p> 	<p>8F Df-18 Flange – 45° Elbow 8000 psi</p> 
<p>8N Df-19 Flange – 90° Elbow 8000 psi</p> 	<p>X5 Df-19 Flange – Straight Full flange system for ISO 6162-1 or ISO 6162-2</p> 	<p>X7 Df-20 Flange – 45° Elbow Full flange system for ISO 6162-1 or ISO 6162-2</p> 	<p>X9 Df-20 Flange – 90° Elbow Full flange system for ISO 6162-1 or ISO 6162-2</p> 
<p>XA Df-21 Caterpillar® Flange Straight</p> 	<p>XF Df-22 Caterpillar® Flange 45° Elbow</p> 	<p>XG Df-22 Caterpillar® Flange 60° Elbow</p> 	<p>XN Df-23 Caterpillar® Flange 90° Elbow</p> 

ORFS

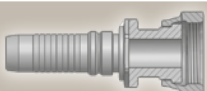
Page Df-23 – Df-25

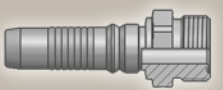
<p>JC Df-24 Female ORFS Swivel – Straight Short ISO 12151-1 – SWSA</p> 	<p>JS Df-24 ORFS Swivel Female (Long) ISO 12151-1-SWSB SAE J516 – ORFS</p> 	<p>J7 Df-25 Female ORFS – Swivel 45° Elbow ISO 12151-1 – SWE 45° SAE J516 – ORFS 45°</p> 	<p>J9 Df-25 Female ORFS – Swivel 90° Elbow – Short Drop ISO 12151-1 – SWES SAE J516 – ORFS 90°</p> 
<p>JM Df-26 ORFS Male ISO 12151-1-S – SAE J516</p> 			

V4 Interlock In-/Outside Skive

4 Wire Hoses

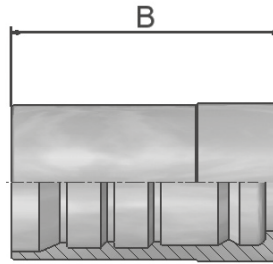

Only for use with adjustable crimpers. Minimum of 320 tons crimping force recommended.

Part Number	 Hose I.D.				B mm
	DN	Inch	Size	mm	
100V4-10	16	5/8	-10	15.9	49
100V4-12	19	3/4	-12	19.1	60
100V4-16	25	1	-16	25.4	75
100V4-20 *	31	1 1/4	-20	31.8	88
100V6-20 *	31	1 1/4	-20	31.8	90
100V4-24 *	38	1 1/2	-24	38.1	94

* not suitable for R42, R42TC and R42ST

V6 Interlock In-/Outside Skive

6 Wire Hoses

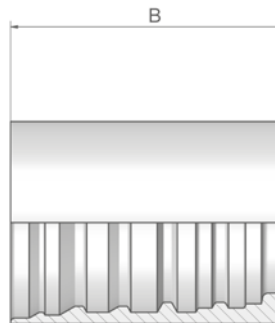

Only for use with adjustable crimpers. Minimum of 340 tons crimping force required.

Part Number	 Hose I.D.				B mm
	DN	Inch	Size	mm	
100V6-24	38	1 1/2	-24	38.1	96
100V6-32	51	2	-32	50.8	110
100V6-40	63	2 1/2	-40	63.5	134
100V6-48	76	3	-48	76.2	110

CA **Female Metric 24°
Light Series with O-Ring
Swivel – Straight**
ISO 12151-2-SWS-L – DKOL

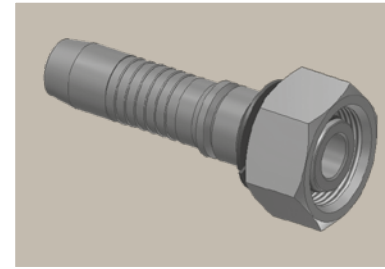
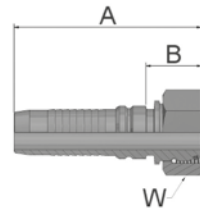

Part Number	Hose I.D.				Thread metric	Tube O.D. mm	A mm	B mm	W mm
	DN	Inch	Size	mm					
KCAV4-22-12	19	3/4	-12	19.1	M30x2	22	89	28	36
KCAV4-28-16	25	1	-16	25.4	M36x2	28	103	31	41
KCAV4-35-20	31	1 1/4	-20	31.8	M45x2	35	120	32	50
KCAV6-35-20	31	1 1/4	-20	31.8	M45x2	35	130	39	50
KCAV4-42-24	38	1 1/2	-24	38.1	M52x2	42	128	35	60
KCAV6-42-24	38	1 1/2	-24	38.1	M52x2	42	138	42	60

Fittings with standard O-ring seals can be used for temperatures from -40 °C up to +105 °C.
O-rings see section Eb. Special O-rings are available on request.

CE **Female Metric 24°
Light Series with O-Ring
Swivel – 45° Elbow**
ISO 12151-2-SWE -L – DKOL 45°

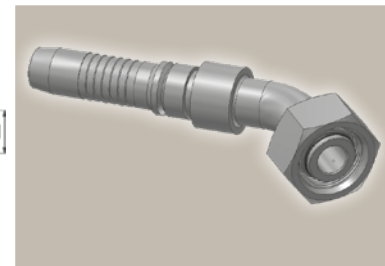
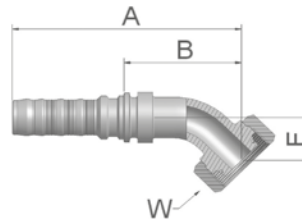

Part Number	Hose I.D.				Thread metric	Tube O.D. mm	A mm	B mm	E mm	W mm
	DN	Inch	Size	mm						
KCEV4-22-12	19	3/4	-12	19.1	M30x2	22	137	75	29	36
KCEV4-35-20	31	1 1/4	-20	31.8	M45x2	35	197	109	37	50
KCEV6-35-20	31	1 1/4	-20	31.8	M45x2	35	188	97	37	50
KCEV6-42-24	38	1 1/2	-24	38.1	M52x2	42	226	130	49	60

Fittings with standard O-ring seals can be used for temperatures from -40 °C up to +105 °C.
O-rings see section Eb. Special O-rings are available on request.

Approved **fitting series** for **hose types**, depending on size: Also available in stainless steel. Details can be found in CAT 4400.1/UK

V4	H31	H31TC	H31ST	R42	R42TC	R42ST	R35	R35TC	RS35TC	R50TC	H29	H29TC	H29ST	FA35
V6	R35	R35TC	RD35TC	RS35TC	R42	R42ST	R42TC	R50TC	FA35	CEM69TC				

CF **Female Metric 24°
Light Series with O-Ring
Swivel – 90° Elbow**
ISO 12151-2-SWE-L – DKOL 90°

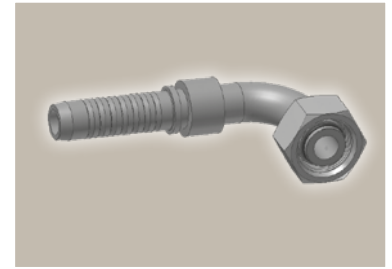
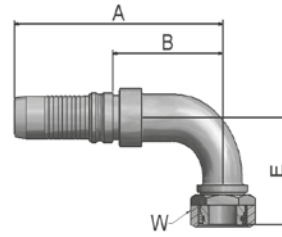

Part Number	Hose I.D.				Thread metric	Tube O.D. mm	A mm	B mm	E mm	W mm
	DN	Inch	Size	mm						
KCFV4-22-16	25	1	-16	25.4	M30x2	22	150	77	70	36
KCFV4-35-20	31	1 1/4	-20	31.8	M45x2	35	186	98	79	50
KCFV6-35-20	31	1 1/4	-20	31.8	M45x2	35	177	86	79	50
KCFV6-42-24	38	1 1/2	-24	38.1	M52x2	42	209	113	101	60

Fittings with standard O-ring seals can be used for temperatures from -40 °C up to +105 °C.
O-rings see section Eb. Special O-rings are available on request.

C9 **Female Metric 24° – Swivel
Heavy Series with O-Ring
Straight**
ISO 12151-2-SWS-S – DKOS

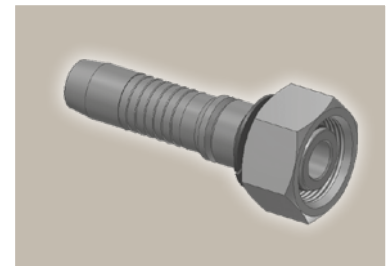
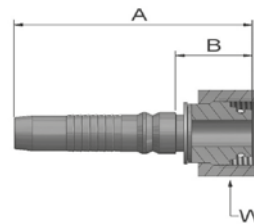

Part Number	Hose I.D.				Thread metric	Tube O.D. mm	A mm	B mm	W mm
	DN	Inch	Size	mm					
KC9V4-20-10	16	5/8	-10	15.9	M30x2	20	87	27	36
KC9V4-20-12	19	3/4	-12	19.1	M30x2	20	88	26	36
KC9V4-25-12	19	3/4	-12	19.1	M36x2	25	91	30.3	46
KC9V4-30-12	19	3/4	-12	19.1	M42x2	30	95	33	50
KC9V4-25-16	25	1	-16	25.4	M36x2	25	103	30	46
KC9V4-30-16	25	1	-16	25.4	M42x2	30	108	35	50
KC9V4-38-16	25	1	-16	25.4	M52x2	38	110	37	60
KC9V4-30-20	31	1 1/4	-20	31.8	M42x2	30	123	35	50
KC9V4-38-20	31	1 1/4	-20	31.8	M52x2	38	126	38	60
KC9V6-30-20	31	1 1/4	-20	31.8	M42x2	30	131.5	41.5	50
KC9V6-38-20	31	1 1/4	-20	31.8	M52x2	38	135	44	60
KC9V4-38-24	38	1 1/2	-24	38.1	M52x2	38	129	36	60
KC9V6-38-24	38	1 1/2	-24	38.1	M52x2	38	139	43	60
KC9V6-54-32	51	2	-32	50.8	M68x2	54	175	65	80

Fittings with standard O-ring seals can be used for temperatures from -40 °C up to +105 °C.
O-rings see section Eb. Special O-rings are available on request.

Approved **fitting series** for hose types, depending on size: Also available in stainless steel. Details can be found in CAT 4400.1/UK

V4	H31	H31TC	H31ST	R42	R42TC	R42ST	R35	R35TC	RS35TC	R50TC	H29	H29TC	H29ST	FA35
V6	R35	R35TC	RD35TC	RS35TC	R42	R42ST	R42TC	R50TC	FA35	CEM69TC				

0C Female Metric 24° – Swivel Heavy Series with O-Ring 45° Elbow

ISO 12151-2 – SWE -S – DKOS 45°

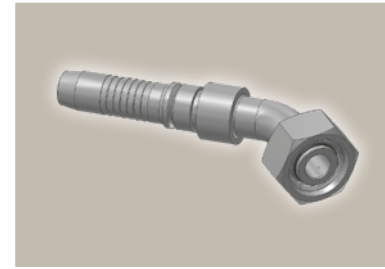
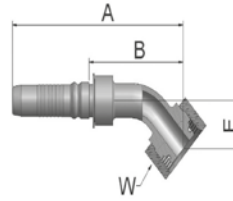

Part Number	Hose I.D.				Thread metric	Tube O.D. mm	A mm	B mm	E mm	W mm
	DN	Inch	Size	mm						
K0CV4-20-10	16	5/8	-10	15.9	M30x2	20	124	65	26	36
K0CV4-20-12	19	3/4	-12	19.1	M30x2	20	138	76	30	36
K0CV4-25-12	19	3/4	-12	19.1	M36x2	25	137	76	29	46
K0CV4-25-16	25	1	-16	25.4	M36x2	25	161	88	33	46
K0CV4-30-16	25	1	-16	25.4	M42x2	30	162	88.7	33	50
K0CV4-30-20	31	1 1/4	-20	31.8	M42x2	30	193	105	34	50
K0CV4-38-20	31	1 1/4	-20	31.8	M52x2	38	197	108.7	37	60
K0CV6-30-20	31	1 1/4	-20	31.8	M42x2	30	184	93	34	50
K0CV6-38-20	31	1 1/4	-20	31.8	M52x2	38	187	96.3	37	60
K0CV4-38-24	38	1 1/2	-24	38.1	M52x2	38	227	133	49	60
K0CV6-38-24	38	1 1/2	-24	38.1	M52x2	38	226	130	49	60

Fittings with standard O-ring seals can be used for temperatures from -40 °C up to +105 °C.
O-rings see section Eb. Special O-rings are available on request.

1C Female Metric 24° – Swivel Heavy Series with O-Ring 90° Elbow

ISO 12151-2-SWE-S – DKOS 90°

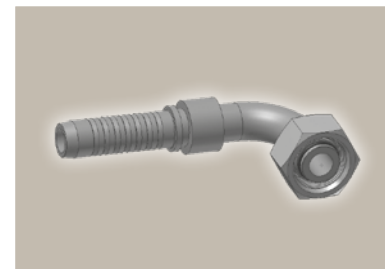
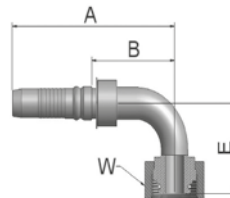

Part Number	Hose I.D.				Thread metric	Tube O.D. mm	A mm	B mm	E mm	W mm
	DN	Inch	Size	mm						
K1CV4-20-10	16	5/8	-10	15.9	M30x2	20	112	52.3	50	36
K1CV4-20-12	19	3/4	-12	19.1	M30x2	20	125	63	60	36
K1CV4-25-12	19	3/4	-12	19.1	M36x2	25	126	65	59	46
K1CV4-25-16	25	1	-16	25.4	M36x2	25	150	77	69	46
K1CV4-30-16	25	1	-16	25.4	M42x2	30	151	77.7	69	50
K1CV4-38-16	25	1	-16	25.4	M52x2	38	150	77	68	60
K1CV4-30-20	31	1 1/4	-20	31.8	M42x2	30	183	95	73	50
K1CV4-38-20	31	1 1/4	-20	31.8	M52x2	38	187	98.7	78	60
K1CV6-30-20	31	1 1/4	-20	31.8	M42x2	30	169	78	69	50
K1CV6-38-20	31	1 1/4	-20	31.8	M52x2	38	177	86.3	78	60
K1CV4-38-24	38	1 1/2	-24	38.1	M52x2	38	210	117	101	60
K1CV6-38-24	38	1 1/2	-24	38.1	M52x2	38	209	113	101	60

Fittings with standard O-ring seals can be used for temperatures from -40 °C up to +105 °C.
O-rings see section Eb. Special O-rings are available on request.

Approved **fitting series** for **hose types**, depending on size: Also available in stainless steel. Details can be found in CAT 4400.1/UK

V4	H31	H31TC	H31ST	R42	R42TC	R42ST	R35	R35TC	RS35TC	R50TC	H29	H29TC	H29ST	FA35
V6	R35	R35TC	RD35TC	RS35TC	R42	R42ST	R42TC	R50TC	FA35	CEM69TC				

D2

Male Metric 24° – Rigid Heavy Series – Straight

ISO 12151-2-S-S – CES

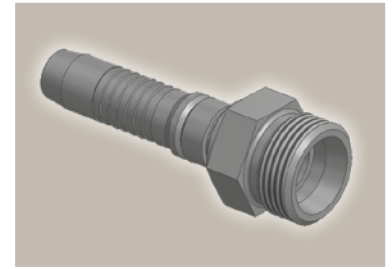
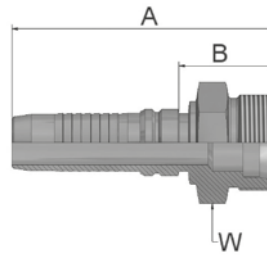

Part Number	Hose I.D.				Thread metric	Tube O.D. mm	A mm	B mm	H mm
	DN	Inch	Size	mm					
KD2V4-20-12	19	3/4	-12	19.1	M30x2	20	96	34	30
KD2V4-25-12	19	3/4	-12	19.1	M36x2	25	98	36.3	36
KD2V4-25-16	25	1	-16	25.4	M36x2	25	110.3	37.7	46
KD2V4-30-16	25	1	-16	25.4	M42x2	30	115	41.7	46
KD2V4-38-20	31	1 1/4	-20	31.8	M52x2	38	135	46.7	55
KD2V6-30-20	31	1 1/4	-20	31.8	M42x2	30	140	59	46
KD2V6-38-20	31	1 1/4	-20	31.8	M52x2	38	142	51	55
KD2V4-38-24	38	1 1/2	-24	38.1	M52x2	38	139	46	55
KD2V6-38-24	38	1 1/2	-24	38.1	M52x2	38	151	55	55

Approved **fitting series** for hose types, depending on size: Also available in stainless steel. Details can be found in CAT 4400.1/UK

V4	H31	H31TC	H31ST	R42	R42TC	R42ST	R35	R35TC	RS35TC	R50TC	H29	H29TC	H29ST	FA35
V6	R35	R35TC	RD35TC	RS35TC	R42	R42ST	R42TC	R50TC	FA35	CEM69TC				

92 Female BSP Parallel Pipe Swivel – Straight (60° Cone)

BS5200-A – DKR

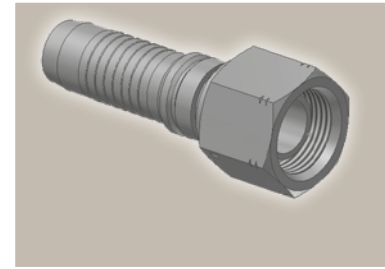
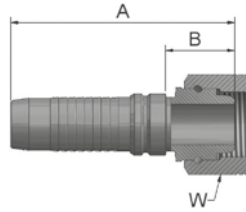

Part Number	Hose I.D.				Thread BSP	A mm	B mm	W mm
	DN	Inch	Size	mm				
K92V4-10-10	16	5/8	-10	15.9	5/8x14	80	20.3	30
K92V4-12-12	19	3/4	-12	19.1	3/4x14	85	23.3	32
K92V4-16-12	19	3/4	-12	19.1	1x11	93	31.3	41
K92V4-16-16	25	1	-16	25.4	1x11	105	32	41
K92V4-20-20	31	1 1/4	-20	31.8	1 1/4x11	118	30	50
K92V6-20-20	31	1 1/4	-20	31.8	1 1/4x11	127	36	50
K92V4-24-24	38	1 1/2	-24	38.1	1 1/2x11	124	30.9	55
K92V6-24-24	38	1 1/2	-24	38.1	1 1/2x11	134	38	55
K92V4-32-32	51	2	-32	50.8	2x11	131	34.2	70
K92V6-32-32	51	2	-32	50.8	2x11	151	41	70

B1 Female BSP Parallel Pipe Swivel 45° Elbow (60° Cone)

BS 5200-D – DKR 45°

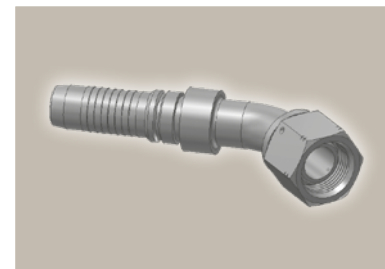
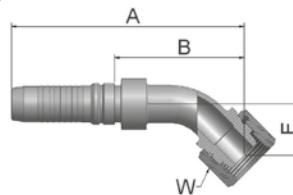

Part Number	Hose I.D.				Thread BSP	A mm	B mm	E mm	W mm
	DN	Inch	Size	mm					
KB1V4-12-12	19	3/4	-12	19.1	3/4x14	134	72.3	26	32
KB1V4-16-16	25	1	-16	25.4	1x11	164	91	36	41
KB1V4-20-20	31	1 1/4	-20	31.8	1 1/4x11	198	109.7	38	50
KB1V6-20-20	31	1 1/4	-20	31.8	1 1/4x11	194	103	43	50
KB1V4-24-24	38	1 1/2	-24	38.1	1 1/2x11	230	137	52	55
KB1V6-24-24	38	1 1/2	-24	38.1	1 1/2x11	229	133	52	55
KB1V4-32-32	51	2	-32	50.8	2x11	277	180	70	70
KB1V6-32-32	51	2	-32	50.8	2x11	288	178	70	70

Approved **fitting series** for **hose types**, depending on size: Also available in stainless steel. Details can be found in CAT 4400.1/UK

V4	H31	H31TC	H31ST	R42	R42TC	R42ST	R35	R35TC	RS35TC	R50TC	H29	H29TC	H29ST	FA35
V6	R35	R35TC	RD35TC	RS35TC	R42	R42ST	R42TC	R50TC	FA35	CEM69TC				

B2 Female BSP Parallel Pipe Swivel 90° Elbow (60° Cone)

BS 5200-B – DKR 90°

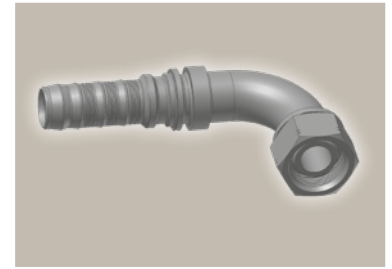
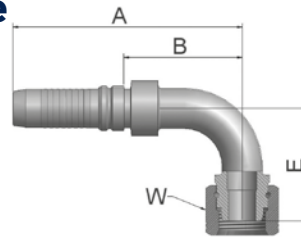

Part Number	Hose I.D.				Thread BSP	A mm	B mm	E mm	W mm
	DN	Inch	Size	mm					
KB2V4-12-12	19	3/4	-12	19.1	3/4x14	125	63.3	55	32
KB2V4-16-16	25	1	-16	25.4	1x11	150	77	74	41
KB2V4-20-20	31	1 1/4	-20	31.8	1 1/4x11	186	98.7	80	50
KB2V6-20-20	31	1 1/4	-20	31.8	1 1/4x11	177	86	80	50
KB2V4-24-24	38	1 1/2	-24	38.1	1 1/2x11	210	116.9	103	55
KB2V6-24-24	38	1 1/2	-24	38.1	1 1/2x11	209	113	103	55
KB2V4-32-32	51	2	-32	50.8	2x11	257	160	149	70
KB2V6-32-32	51	2	-32	50.8	2x11	268	157	149	70

D9 Male BSP Parallel Pipe Rigid – Straight (60° Cone)

BS5200 – AGR

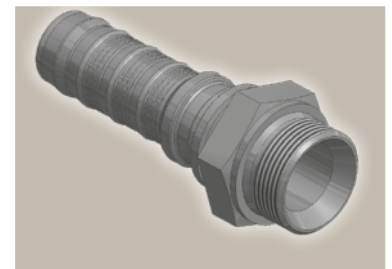
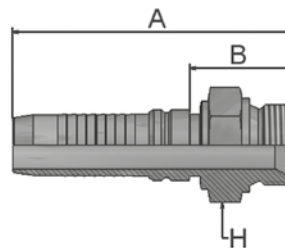

Part Number	Hose I.D.				Thread BSP	A mm	B mm	H mm
	DN	Inch	Size	mm				
KD9V4-10-10	16	5/8	-10	15.9	5/8x14	94	35	30
KD9V4-12-12	19	3/4	-12	19.1	3/4x14	99	37.3	32
KD9V4-16-16	25	1	-16	25.4	1x11	115	42.7	41
KD9V4-20-20	31	1 1/4	-20	31.8	1 1/4x11	134	46.2	50
KD9V6-20-20	31	1 1/4	-20	31.8	1 1/4x11	139	48	50
KD9V4-24-24	38	1 1/2	-24	38.1	1 1/2x11	142	48.4	55
KD9V6-24-24	38	1 1/2	-24	38.1	1 1/2x11	155	58	55
KD9V4-32-32	51	2	-32	50.8	2x11	148	50	70
KD9V6-32-32	51	2	-32	50.8	2x11	168	58	70

Approved **fitting series** for **hose types**, depending on size: Also available in stainless steel. Details can be found in CAT 4400.1/UK

V4	H31	H31TC	H31ST	R42	R42TC	R42ST	R35	R35TC	RS35TC	R50TC	H29	H29TC	H29ST	FA35
V6	R35	R35TC	RD35TC	RS35TC	R42	R42ST	R42TC	R50TC	FA35	CEM69TC				

91 Male BSP Taper Pipe – Rigid Straight

BS5200 – AGR-K

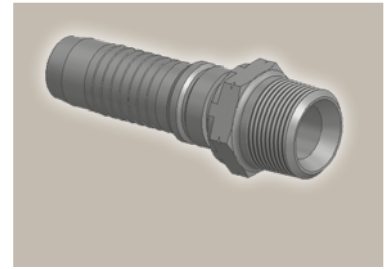
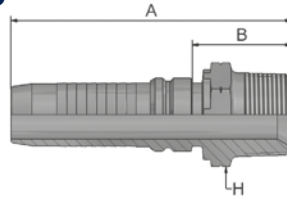

Part Number	Hose I.D.				Thread BSP	A mm	B mm	H mm
	DN	Inch	Size	mm				
K91V4-12-12	19	3/4	-12	19.1	3/4x14	99	37	30
K91V4-16-16	25	1	-16	25.4	1x11	113	40	36
K91V4-20-20	31	1 1/4	-20	31.8	1 1/4x11	138	50	46
K91V4-24-24	38	1 1/2	-24	38.1	1 1/2x11	144	59	55
K91V4-32-32	51	2	-32	50.8	2x11	154	56	65

Approved **fitting series** for **hose types**, depending on size: Also available in stainless steel. Details can be found in CAT 4400.1/UK

V4	H31	H31TC	H31ST	R42	R42TC	R42ST	R35	R35TC	RS35TC	R50TC	H29	H29TC	H29ST	FA35
V6	R35	R35TC	RD35TC	RS35TC	R42	R42ST	R42TC	R50TC	FA35	CEM69TC				

01

Male NPTF Pipe Rigid – Straight

SAE J476A / J516 – AGN

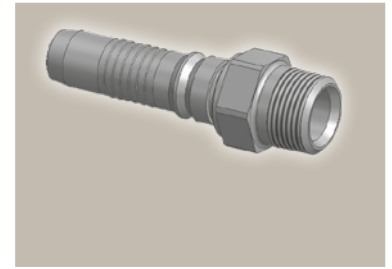
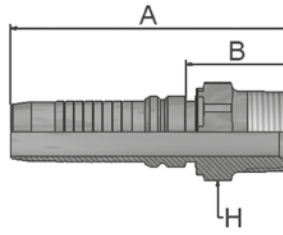

Part Number	Hose I.D.				Thread NPTF	A mm	B mm	H mm
	DN	Inch	Size	mm				
K01V4-12-12	19	3/4	-12	19.1	3/4-14	100	38.3	30
K01V4-16-16	25	1	-16	25.4	1-11 1/2	116.5	43.9	36
K01V4-20-20	31	1 1/4	-20	31.8	1 1/4-11 1/2	146	58.2	46
K01V6-20-20	31	1 1/4	-20	31.8	1 1/4-11 1/2	151	60.2	46
K01V4-24-24	38	1 1/2	-24	38.1	1 1/2-11 1/2	148.4	55.3	50
K01V6-24-24	38	1 1/2	-24	38.1	1 1/2-11 1/2	159	62.7	50
K01V4-32-32	51	2	-32	50.8	2-11 1/2	159.8	62.3	65
K01V6-32-32	51	2	-32	50.8	2-11 1/2	181	70	65

03

Male JIC 37° – Rigid Straight

ISO12151-5-S – AGJ

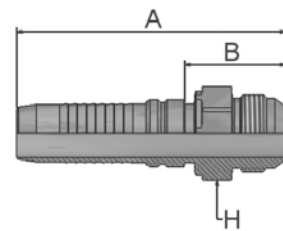

Part Number	Hose I.D.				Thread UNF	A mm	B mm	H mm
	DN	Inch	Size	mm				
K03V4-12-12	19	3/4	-12	19.1	1 1/16x12	101	39.3	30
K03V4-16-12	19	3/4	-12	19.1	1 5/16x12	103	41.3	36
K03V4-16-16	25	1	-16	25.4	1 5/16x12	117	44.1	36
K03V4-20-16	25	1	-16	25.4	1 5/8x12	122	49.5	46
K03V4-20-20	31	1 1/4	-20	31.8	1 5/8x12	139	50.7	46
K03V4-24-20	31	1 1/4	-20	31.8	1 7/8x12	139	51	50
K03V6-20-20	31	1 1/4	-20	31.8	1 5/8x12	147	56	46
K03V4-24-24	38	1 1/2	-24	38.1	1 7/8x12	146	52.6	50
K03V6-24-24	38	1 1/2	-24	38.1	1 7/8x12	156	60	50
K03V4-32-32	51	2	-32	50.8	2 1/2x12	161	64	65
K03V6-32-32	51	2	-32	50.8	2 1/2x12	182	72	65

Approved **fitting series** for hose types, depending on size: Also available in stainless steel. Details can be found in CAT 4400.1/UK

V4	H31 H31TC H31ST R42 R42TC R42ST R35 R35TC RS35TC R50TC H29 H29TC H29ST FA35
V6	R35 R35TC RD35TC RS35TC R42 R42ST R42TC R50TC FA35 CEM69TC

06 Female JIC 37° – Swivel Straight

ISO12151-5-SWS – DKJ

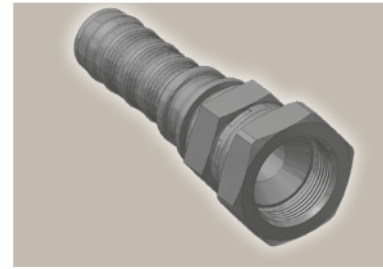
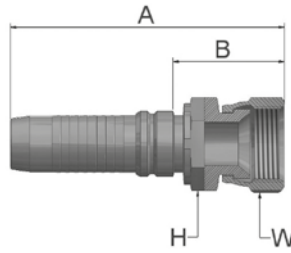

Part Number	Hose I.D.				Thread UNF	A mm	B mm	H mm	W mm
	DN	Inch	Size	mm					
K06V4-12-12	19	3/4	-12	19.1	1 1/16x12	105	43	30	32
K06V4-16-12	19	3/4	-12	19.1	1 5/16x12	109	48	36	41
K06V4-16-16	25	1	-16	25.4	1 5/16x12	122	50	36	41
K06V4-20-16	25	1	-16	25.4	1 5/8x12	125	52	41	50
K06V4-20-20	31	1 1/4	-20	31.8	1 5/8x12	146	58	46	50
K06V4-24-20	31	1 1/4	-20	31.8	1 7/8x12	150	63	50	60
K06V6-20-20	31	1 1/4	-20	31.8	1 5/8x12	154	63	46	50
K06V6-24-20	31	1 1/4	-20	31.8	1 7/8x12	159	68	50	60
K06V4-24-24	38	1 1/2	-24	38.1	1 7/8x12	152	59	50	60
K06V6-24-24	38	1 1/2	-24	38.1	1 7/8x12	163	67	50	60
K06V4-32-32	51	2	-32	50.8	2 1/2x12	168	70	65	75
K06V6-32-32	51	2	-32	50.8	2 1/2x12	188	77	65	75

37 Female JIC 37° – Swivel 45° Elbow

ISO 12151-5-SWE 45° – DKJ 45°

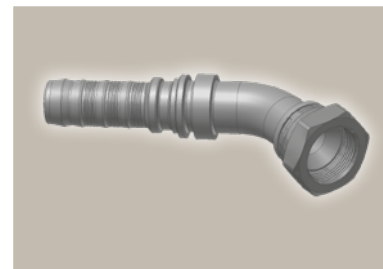
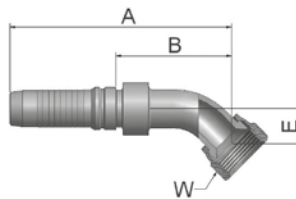

Part Number	Hose I.D.				Thread UNF	A mm	B mm	E mm	W mm
	DN	Inch	Size	mm					
K37V4-12-12	19	3/4	-12	19.1	1 1/16x12	129	67	22	32
K37V4-16-16	25	1	-16	25.4	1 5/16x12	152	79.7	24	41
K37V4-20-20	31	1 1/4	-20	31.8	1 5/8x12	201	113	42	50
K37V6-20-20	31	1 1/4	-20	31.8	1 5/8x12	192	101	42	50
K37V4-24-24	38	1 1/2	-24	38.1	1 7/8x12	227	133.9	49	60
K37V6-24-24	38	1 1/2	-24	38.1	1 7/8x12	235	139	58	60
K37V4-32-32	51	2	-32	50.8	2 1/2x12	279	182	72	75
K37V6-32-32	51	2	-32	50.8	2 1/2x12	290	180	72	75

Approved **fitting series** for **hose types**, depending on size: Also available in stainless steel. Details can be found in CAT 4400.1/UK

V4	H31	H31TC	H31ST	R42	R42TC	R42ST	R35	R35TC	RS35TC	R50TC	H29	H29TC	H29ST	FA35
V6	R35	R35TC	RD35TC	RS35TC	R42	R42ST	R42TC	R50TC	FA35	CEM69TC				

39

**Female JIC 37° – Swivel
90° Elbow**

ISO 12151-5-SWES – DKJ 90°

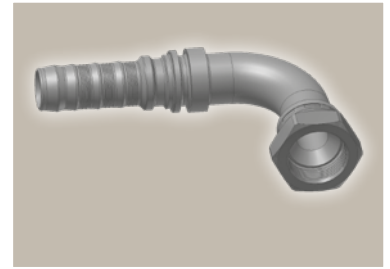
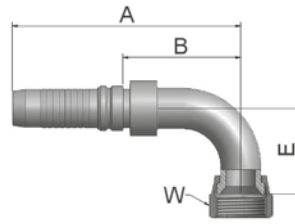

Part Number	Hose I.D.				Thread UNF	A mm	B mm	E mm	W mm
	DN	Inch	Size	mm					
K39V4-12-12	19	3/4	-12	19.1	1 1/16x12	125	63.3	48	32
K39V4-16-12	19	3/4	-12	19.1	1 5/16x12	125	63.3	56	41
K39V4-16-16	25	1	-16	25.4	1 5/16x12	150	77.7	56	41
K39V4-20-16	25	1	-16	25.4	1 5/8x12	150	77	62	50
K39V4-20-20	31	1 1/4	-20	31.8	1 5/8x12	186	98	85	50
K39V4-24-20	31	1 1/4	-20	31.8	1 7/8x12	186	98	80	60
K39V6-20-20	31	1 1/4	-20	31.8	1 5/8x12	177	86	85	50
K39V4-24-24	38	1 1/2	-24	38.1	1 7/8x12	210	116.9	102	60
K39V6-24-24	38	1 1/2	-24	38.1	1 7/8x12	209	113	102	60
K39V4-32-32	51	2	-32	50.8	2 1/2x12	257	160	152	75
K39V6-32-32	51	2	-32	50.8	2 1/2x12	268	157	152	75

Approved **fitting series** for hose types, depending on size: Also available in stainless steel. Details can be found in CAT 4400.1/UK

V4	H31	H31TC	H31ST	R42	R42TC	R42ST	R35	R35TC	RS35TC	R50TC	H29	H29TC	H29ST	FA35
V6	R35	R35TC	RD35TC	RS35TC	R42	R42ST	R42TC	R50TC	FA35	CEM69TC				

15/4A ISO 6162-1-Flange Straight

ISO 12151-3-S-L – SFL
(35.0 MPa/ 5000 psi)

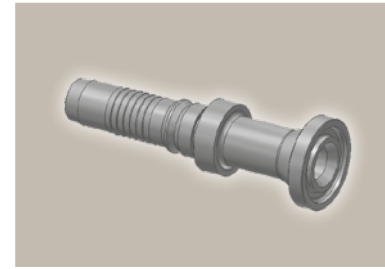
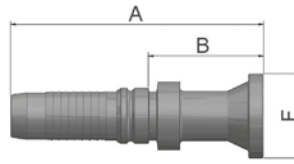

Part Number	Hose I.D.				Flange Inch	A mm	B mm	F mm
	DN	Inch	Size	mm				
K15V4-12-12	19	3/4	-12	19.1	3/4	119	58	38
K15V4-16-12	19	3/4	-12	19.1	1	100	38.3	45
K15V4-12-16	25	1	-16	25.4	3/4	134.8	62.2	38
K15V4-16-16	25	1	-16	25.4	1	133	61	45
K4AV4-20-16	25	1	-16	25.4	1 1/4	101	28	51
K15V4-16-20	31	1 1/4	-20	31.8	1	152	64	45
K4AV4-20-20	31	1 1/4	-20	31.8	1 1/4	160	72	51
K4AV4-24-20	31	1 1/4	-20	31.8	1 1/2	126	38.7	60
K15V6-16-20	31	1 1/4	-20	31.8	1	161	70	44
K4AV6-20-20	31	1 1/4	-20	31.8	1 1/4	167	76	51
K4AV6-24-20	31	1 1/4	-20	31.8	1 1/2	165	74	60
K4AV4-20-24	38	1 1/2	-24	38.1	1 1/4	167	73	51
K4AV4-24-24	38	1 1/2	-24	38.1	1 1/2	190	97	60
K4AV4-32-24	38	1 1/2	-24	38.1	2	149	56	71
K4AV6-24-24	38	1 1/2	-24	38.1	1 1/2	201	105	60
K4AV6-32-24	38	1 1/2	-24	38.1	2	159	63	71
K4AV4-32-32	51	2	-32	50.8	2	189	92	71
K4AV6-32-32	51	2	-32	50.8	2	210	100	71

Approved **fitting series** for **hose types**, depending on size: Also available in stainless steel. Details can be found in CAT 4400.1/UK

V4	H31	H31TC	H31ST	R42	R42TC	R42ST	R35	R35TC	RS35TC	R50TC	H29	H29TC	H29ST	FA35
V6	R35	R35TC	RD35TC	RS35TC	R42	R42ST	R42TC	R50TC	FA35	CEM69TC				

17/4F ISO 6162-1-Flange 45° Elbow

ISO 12151-3 – E45S – L – SFL 45°
(35.0 MPa/ 5000 psi)

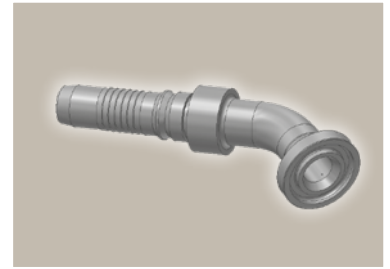
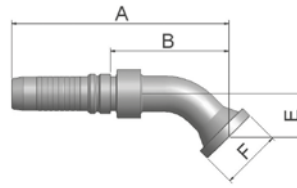

Part Number	Hose I.D.				Flange Inch	A mm	B mm	E mm	F mm
	DN	Inch	Size	mm					
K17V4-12-12	19	3/4	-12	19.1	3/4	133	72	26	38
K17V4-16-12	19	3/4	-12	19.1	1	133	72	26	45
K4FV4-20-12	19	3/4	-12	19.1	1 1/4	133	71	25	51
K17V4-16-16	25	1	-16	25.4	1	160	87	32	45
K4FV4-20-16	25	1	-16	25.4	1 1/4	160	87	32	51
K17V4-16-20	31	1 1/4	-20	31.8	1	198	109.7	38	45
K4FV4-20-20	31	1 1/4	-20	31.8	1 1/4	198	109.7	38	51
K4FV4-24-20	31	1 1/4	-20	31.8	1 1/2	198	109.7	38	60
K17V6-16-20	31	1 1/4	-20	31.8	1	188	97	38	44
K4FV6-20-20	31	1 1/4	-20	31.8	1 1/4	188	97	38	51
K4FV6-24-20	31	1 1/4	-20	31.8	1 1/2	188	97	38	60
K4FV4-24-24	38	1 1/2	-24	38.1	1 1/2	222	128.9	44	60
K4FV4-32-24	38	1 1/2	-24	38.1	2	222	128.9	44	71
K4FV6-20-24	38	1 1/2	-24	38.1	1 1/4	201	105	44	51
K4FV6-24-24	38	1 1/2	-24	38.1	1 1/2	221	125	44	60
K4FV6-32-24	38	1 1/2	-24	38.1	2	221	125	44	71
K4FV4-32-32	51	2	-32	50.8	2	269	171	62	71
K4FV6-32-32	51	2	-32	50.8	2	280	169	62	71

Approved **fitting series** for hose types, depending on size: Also available in stainless steel. Details can be found in CAT 4400.1/UK

V4	H31	H31TC	H31ST	R42	R42TC	R42ST	R35	R35TC	RS35TC	R50TC	H29	H29TC	H29ST	FA35
V6	R35	R35TC	RD35TC	RS35TC	R42	R42ST	R42TC	R50TC	FA35	CEM69TC				

19/4N ISO 6162-1-Flange 90° Elbow

ISO 12151-3-E-L – SFL 90°
(35.0 MPa/ 5000 psi)

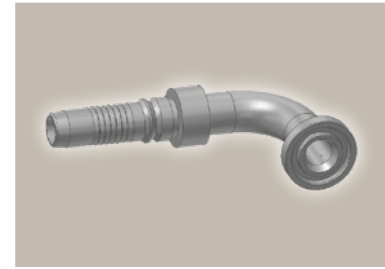
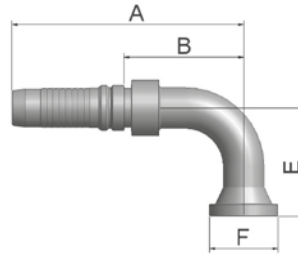

Part Number	Hose I.D.				Flange Inch	A mm	B mm	E mm	F mm
	DN	Inch	Size	mm					
K19V4-12-12	19	3/4	-12	19.1	3/4	125	63.3	58	38
K19V4-16-12	19	3/4	-12	19.1	1	125	63.3	58	45
K19V4-16-16	25	1	-16	25.4	1	150	77.7	70	45
K4NV4-20-16	25	1	-16	25.4	1 1/4	150	77	69	51
K19V4-16-20	31	1 1/4	-20	31.8	1	186	98	90	45
K4NV4-20-20	31	1 1/4	-20	31.8	1 1/4	186	98.2	90	51
K4NV4-24-20	31	1 1/4	-20	31.8	1 1/2	186	98	90	60
K4NV4-24-20-SL110	31	1 1/4	-20	31.8	1 1/2	186	98	110	60
K19V6-16-20	31	1 1/4	-20	31.8	1	177	86	90	44
K4NV6-20-20	31	1 1/4	-20	31.8	1 1/4	177	86	90	51
K4NV6-24-20	31	1 1/4	-20	31.8	1 1/2	177	86	90	60
K4NV4-20-24	38	1 1/2	-24	38.1	1 1/4	197	103	104	51
K4NV4-24-24	38	1 1/2	-24	38.1	1 1/2	210	116.9	104	60
K4NV4-24-24-SL150	38	1 1/2	-24	38.1	1 1/2	210	116.9	150	60
K4NV4-24-24-SL200	38	1 1/2	-24	38.1	1 1/2	210	116.9	200	60
K4NV4-32-24	38	1 1/2	-24	38.1	2	210	116.9	104	71
K4NV6-20-24	38	1 1/2	-24	38.1	1 1/4	184	88	104	51
K4NV6-24-24	38	1 1/2	-24	38.1	1 1/2	209	113	104	60
K4NV6-32-24	38	1 1/2	-24	38.1	2	209	113	104	71
K4NV4-24-32	51	2	-32	50.8	1 1/2	227	130	138	60
K4NV4-32-32	51	2	-32	50.8	2	257	160.2	138	71
K4NV6-32-32	51	2	-32	50.8	2	268	157	138	71

Approved **fitting series** for **hose types**, depending on size: Also available in stainless steel. Details can be found in CAT 4400.1/UK

V4	H31	H31TC	H31ST	R42	R42TC	R42ST	R35	R35TC	RS35TC	R50TC	H29	H29TC	H29ST	FA35
V6	R35	R35TC	RD35TC	RS35TC	R42	R42ST	R42TC	R50TC	FA35	CEM69TC				

6A

ISO 6162-2-Flange Straight

ISO 12151-3-S-S – SFS
(42.0 MPa/ 6000 psi)

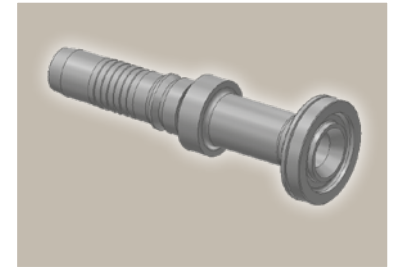
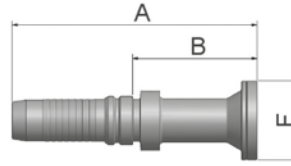

Part Number	Hose I.D.				Flange Inch	A mm	B mm	F mm
	DN	Inch	Size	mm				
K6AV4-8-10	16	5/8	-10	15.9	1/2	121	62	32
K6AV4-12-10	16	5/8	-10	15.9	3/4	94	33.8	41
K6AV4-12-12	19	3/4	-12	19.1	3/4	126	64.4	41
K6AV4-16-12	19	3/4	-12	19.1	1	100	38	48
K6AV4-12-16	25	1	-16	25.4	3/4	150	77	41
K6AV4-16-16	25	1	-16	25.4	1	148	75	48
K6AV4-20-16	25	1	-16	25.4	1 1/4	116	44	54
K6AV4-24-16	25	1	-16	25.4	1 1/2	118	45	64
K6AV4-16-20	31	1 1/4	-20	31.8	1	166	78	48
K6AV4-20-20	31	1 1/4	-20	31.8	1 1/4	166	78	54
K6AV4-24-20	31	1 1/4	-20	31.8	1 1/2	139	51	64
K6AV6-16-20	31	1 1/4	-20	31.8	1	175	84	48
K6AV6-20-20	31	1 1/4	-20	31.8	1 1/4	175	83	54
K6AV6-24-20	31	1 1/4	-20	31.8	1 1/2	147	56	64
K6AV4-20-24	38	1 1/2	-24	38.1	1 1/4	174	81	54
K6AV4-24-24	38	1 1/2	-24	38.1	1 1/2	192	99	64
K6AV4-32-24	38	1 1/2	-24	38.1	2	184	91	79
K6AV6-20-24	38	1 1/2	-24	38.1	1 1/4	185	89	54
K6AV6-24-24	38	1 1/2	-24	38.1	1 1/2	202	106	64
K6AV6-32-24	38	1 1/2	-24	38.1	2	194	98	79
K6AV4-24-32	51	2	-32	50.8	1 1/2	198	101	64
K6AV4-32-32	51	2	-32	50.8	2	212	115	79
K6AV6-24-32	51	2	-32	50.8	1 1/2	219	108.3	64
K6AV6-32-32	51	2	-32	50.8	2	233	122	79
K6AV6-32-40	63	2 1/2	-40	63.5	2	252	117	79
K6AV6-40-40	63	2 1/2	-40	63.5	2 1/2	253	118	108
K6AV6-48-40	63	2 1/2	-40	63.5	3	250	115	132
K6AV6-48-48	76	3	-48	76.2	3	240	133	132

V4/V6 Series

Approved **fitting series** for hose types, depending on size: Also available in stainless steel. Details can be found in CAT 4400.1/UK

V4	H31	H31TC	H31ST	R42	R42TC	R42ST	R35	R35TC	RS35TC	R50TC	H29	H29TC	H29ST	FA35
V6	R35	R35TC	RD35TC	RS35TC	R42	R42ST	R42TC	R50TC	FA35	CEM69TC				

6F ISO 6162-2-Flange 45° Elbow – Heavy Series

ISO 12151-3 – E45-S – SFS 45°
(42.0 MPa/ 6000 psi)

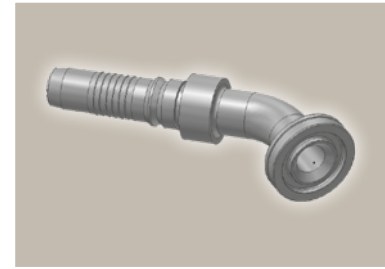
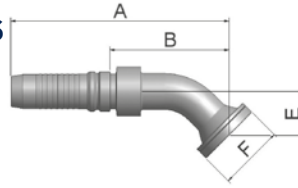

Part Number	Hose I.D.				Flange Inch	A mm	B mm	E mm	F mm
	DN	Inch	Size	mm					
K6FV4-8-10	16	5/8	-10	15.9	1/2	123	63.3	26	32
K6FV4-12-10	16	5/8	-10	15.9	3/4	123	63.3	26	41
K6FV4-12-12	19	3/4	-12	19.1	3/4	133	72	26	41
K6FV4-12-12-SL55	19	3/4	-12	19.1	3/4	162	101	55	41
K6FV4-16-12	19	3/4	-12	19.1	1	133	71.3	26	48
K6FV4-16-12-SL55	19	3/4	-12	19.1	1	162	101	55	48
K6FV4-12-16	25	1	-16	25.4	3/4	155	78	32	41
K6FV4-16-16	25	1	-16	25.4	1	160	87	32	48
K6FV4-16-16-SL55	25	1	-16	25.4	1	183	110	55	48
K6FV4-20-16	25	1	-16	25.4	1 1/4	161	88.7	32	54
K6FV4-20-16-SL55	25	1	-16	25.4	1 1/4	184	112	55	54
K6FV4-16-20	31	1 1/4	-20	31.8	1	198	109.7	38	48
K6FV4-20-20	31	1 1/4	-20	31.8	1 1/4	198	109.7	38	54
K6FV4-20-20-SL60	31	1 1/4	-20	31.8	1 1/4	220	132	60	54
K6FV4-24-20	31	1 1/4	-20	31.8	1 1/2	198	109.7	38	64
K6FV4-24-20-SL60	31	1 1/4	-20	31.8	1 1/2	220	132	60	64
K6FV6-16-20	31	1 1/4	-20	31.8	1	188	97	38	48
K6FV6-20-20	31	1 1/4	-20	31.8	1 1/4	189	97.3	38	54
K6FV6-20-20-SL60	31	1 1/4	-20	31.8	1 1/4	210	119	60	54
K6FV6-24-20	31	1 1/4	-20	31.8	1 1/2	189	97.3	38	64
K6FV4-24-24	38	1 1/2	-24	38.1	1 1/2	222	128.9	44	64
K6FV4-24-24-SL70	38	1 1/2	-24	38.1	1 1/2	248	155	70	64
K6FV4-32-24	38	1 1/2	-24	38.1	2	222	128.9	44	79
K6FV6-20-24	38	1 1/2	-24	38.1	1 1/4	209	113.3	44	54
K6FV6-24-24	38	1 1/2	-24	38.1	1 1/2	221	125.3	44	64
K6FV6-24-24-SL70	38	1 1/2	-24	38.1	1 1/2	247	151	70	64
K6FV6-32-24	38	1 1/2	-24	38.1	2	221	125.3	44	79
K6FV4-32-32	51	2	-32	50.8	2	263	166	56	79
K6FV4-32-32-SL70	51	2	-32	50.8	2	277	180	70	79
K6FV6-24-32	51	2	-32	50.8	1 1/2	260	149.3	56	64
K6FV6-32-32	51	2	-32	50.8	2	274	163.3	56	79

Approved **fitting series** for **hose types**, depending on size: Also available in stainless steel. Details can be found in CAT 4400.1/UK

V4	H31	H31TC	H31ST	R42	R42TC	R42ST	R35	R35TC	RS35TC	R50TC	H29	H29TC	H29ST	FA35
V6	R35	R35TC	RD35TC	RS35TC	R42	R42ST	R42TC	R50TC	FA35	CEM69TC				

6N

ISO 6162-2-Flange 90° Elbow

ISO 12151-3 – E-S – SFS 90°
(42.0 MPa/ 6000 psi)

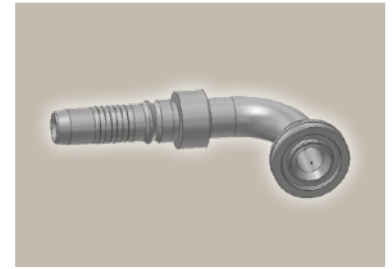
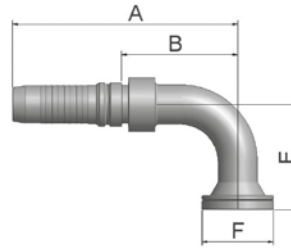

Part Number	Hose I.D.				Flange Inch	A mm	B mm	E mm	F mm
	DN	Inch	Size	mm					
K6NV4-8-10	16	5/8	-10	15.9	1/2	111	51	54	32
K6NV4-12-10	16	5/8	-10	15.9	3/4	111	50.3	54	41
K6NV4-12-12	19	3/4	-12	19.1	3/4	125	63.3	58	41
K6NV4-12-12-SL100	19	3/4	-12	19.1	3/4	125	63	100	41
K6NV4-16-12	19	3/4	-12	19.1	1	125	63.3	58	48
K6NV4-16-12-SL100	19	3/4	-12	19.1	1	125	63	100	48
K6NV4-12-16	25	1	-16	25.4	3/4	140	67	70	41
K6NV4-12-16-SL55	25	1	-16	25.4	3/4	140	67	55	41
K6NV4-16-16	25	1	-16	25.4	1	150	77.7	70	48
K6NV4-16-16-SL100	25	1	-16	25.4	1	150	77	100	48
K6NV4-20-16	25	1	-16	25.4	1 1/4	154	81	70	54
K6NV4-20-16-SL115	25	1	-16	25.4	1 1/4	154	81	115	54
K6NV4-16-20	31	1 1/4	-20	31.8	1	186	98.7	90	48
K6NV4-20-20	31	1 1/4	-20	31.8	1 1/4	186	98.7	90	54
K6NV4-20-20-SL120	31	1 1/4	-20	31.8	1 1/4	186	98	120	54
K6NV4-20-20-SL330	31	1 1/4	-20	31.8	1 1/4	186	98	330	54
K6NV4-24-20	31	1 1/4	-20	31.8	1 1/2	186	98.7	90	64
K6NV4-24-20-SL135	31	1 1/4	-20	31.8	1 1/2	186	98	135	64
K6NV6-16-20	31	1 1/4	-20	31.8	1	177	86	90	48
K6NV6-20-20	31	1 1/4	-20	31.8	1 1/4	177	86.3	90	54
K6NV6-20-20-SL120	31	1 1/4	-20	31.8	1 1/4	177	86	120	54
K6NV6-24-20	31	1 1/4	-20	31.8	1 1/2	177	86.3	90	64
K6NV4-20-24	38	1 1/2	-24	38.1	1 1/4	197	103.9	104	54
K6NV4-24-24	38	1 1/2	-24	38.1	1 1/2	210	116.9	104	64
K6NV4-24-24-SL140	38	1 1/2	-24	38.1	1 1/2	210	117	140	64
K6NV4-24-24-SL160	38	1 1/2	-24	38.1	1 1/2	210	117	160	64
K6NV4-24-24-SL200	38	1 1/2	-24	38.1	1 1/2	210	117	200	64
K6NV4-32-24	38	1 1/2	-24	38.1	2	210	116.9	104	79
K6NV6-20-24	38	1 1/2	-24	38.1	1 1/4	192	96.3	104	54
K6NV6-24-24	38	1 1/2	-24	38.1	1 1/2	210	113.3	104	64
K6NV6-32-24	38	1 1/2	-24	38.1	2	209	113.3	104	79
K6NV4-24-32	51	2	-32	50.8	1 1/2	221	124	104	64
K6NV4-32-32	51	2	-32	50.8	2	257	160	138	79
K6NV6-24-32	51	2	-32	50.8	1 1/2	236	125.3	104	64
K6NV6-32-32	51	2	-32	50.8	2	268	157.3	138	79

V4/V6 Series



Approved **fitting series** for hose types, depending on size: Also available in stainless steel. Details can be found in CAT 4400.1/UK

V4	H31	H31TC	H31ST	R42	R42TC	R42ST	R35	R35TC	RS35TC	R50TC	H29	H29TC	H29ST	FA35
V6	R35	R35TC	RD35TC	RS35TC	R42	R42ST	R42TC	R50TC	FA35	CEM69TC				

8A Flange – Straight

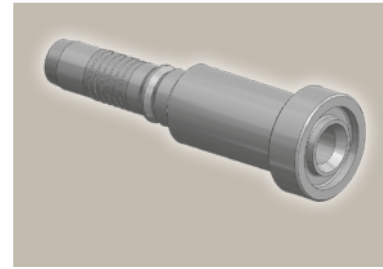
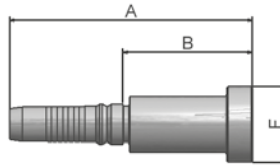
8000 psi





Part Number	 Hose I.D.				 Flange	A	B	F
	DN	Inch	Size	mm	Inch	mm	mm	mm
K8AV4-12-10	16	5/8	-10	15.9	3/4	130	71	41
K8AV4-12-12	19	3/4	-12	19.1	3/4	132	71	41
K8AV4-16-12	19	3/4	-12	19.1	1	143	82	48
K8AV4-16-16	25	1	-16	25.4	1	148	75	48
K8AV4-20-16	25	1	-16	25.4	1 1/4	111	39	54
K8AV6-20-20	31	1 1/4	-20	31.8	1 1/4	190	88	54

8F Flange – 45° Elbow

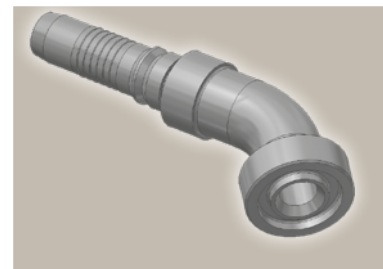
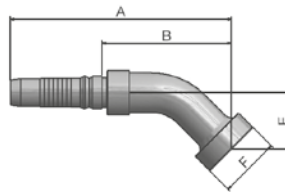
8000 psi



Part Number	 Hose I.D.				 Flange	A	B	E	F
	DN	Inch	Size	mm	Inch	mm	mm	mm	mm
K8FV4-12-10	16	5/8	-10	15.9	3/4	123	64	26	41
K8FV4-12-12	19	3/4	-12	19.1	3/4	138	76	26	41
K8FV4-16-12	19	3/4	-12	19.1	1	143	81	32	48
K8FV4-16-16	25	1	-16	25.4	1	178	105	35	48
K8FV4-20-16	25	1	-16	25.4	1 1/4	178	105	35	54
K8FV6-20-20	31	1 1/4	-20	31.8	1 1/4	194	103	38	54

Approved **fitting series** for **hose types**, depending on size: Also available in stainless steel. Details can be found in CAT 4400.1/UK

V4	H31	H31TC	H31ST	R42	R42TC	R42ST	R35	R35TC	RS35TC	R50TC	H29	H29TC	H29ST	FA35
V6	R35	R35TC	RD35TC	RS35TC	R42	R42ST	R42TC	R50TC	FA35	CEM69TC				

8N Flange – 90° Elbow

8000 psi

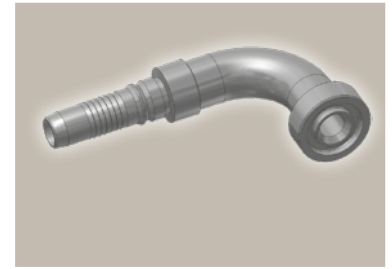
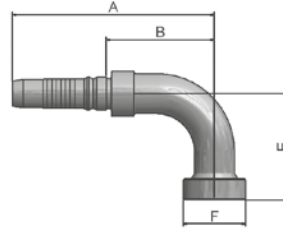

Part Number	Hose I.D.				Flange Inch	A mm	B mm	E mm	F mm
	DN	Inch	Size	mm					
K8NV4-12-10	16	5/8	-10	15.9	3/4	111	51	58	41
K8NV4-12-12	19	3/4	-12	19.1	3/4	133	71	70	41
K8NV4-16-12	19	3/4	-12	19.1	1	133	71	70	48
K8NV4-16-16	25	1	-16	25.4	1	170	97	75	48
K8NV4-20-16	25	1	-16	25.4	1 1/4	170	97	90	54
K8NV6-20-20	31	1 1/4	-20	31.8	1 1/4	182	91	90	54

X5 Flange – Straight

Full flange system for
ISO 6162-1 or ISO 6162-2

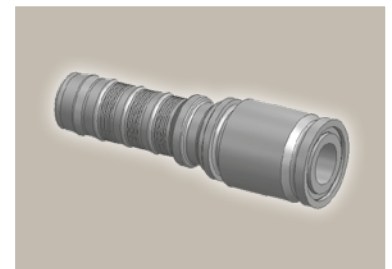
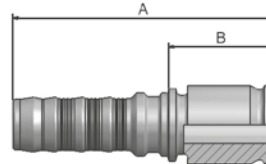

Part Number	Hose I.D.				Flange Inch	A mm	B mm
	DN	Inch	Size	mm			
KX5V6-20-20	31	1 1/4	-20	31.8	1 1/4	152.3	61.3
KX5V6-24-24	38	1 1/2	-24	38.1	1 1/2	159.3	63.3
KX5V6-32-32	51	2	-32	50.8	2	188	78
KX5V6-40-40	63	2 1/2	-40	63.5	2 1/2	233	83
KX5V6-48-40	63	2 1/2	-40	63.5	3	233	98



Approved **fitting series** for hose types, depending on size: Also available in stainless steel. Details can be found in CAT 4400.1/UK

V4	H31 H31TC H31ST R42 R42TC R42ST R35 R35TC RS35TC R50TC H29 H29TC H29ST FA35
V6	R35 R35TC RD35TC RS35TC R42 R42ST R42TC R50TC FA35 CEM69TC

X7 Flange – 45° Elbow

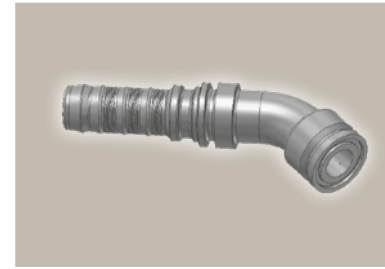
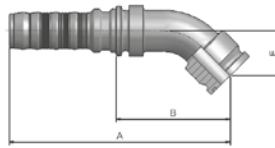
Full flange system for
ISO 6162-1 or ISO 6162-2





Part Number	 Hose I.D.				 Flange	A	B	E
	DN	Inch	Size	mm	Inch	mm	mm	mm
KX7V6-20-20	31	1 1/4	-20	31.8	1 1/4	190	99	39
KX7V6-24-24	38	1 1/2	-24	38.1	1 1/2	221	125	44
KX7V6-32-32	51	2	-32	50.8	2	275	164.5	57

X9 Flange – 90° Elbow

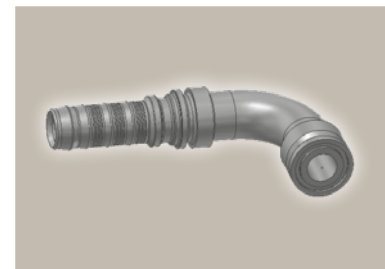
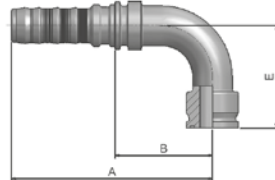
Full flange system for
ISO 6162-1 or ISO 6162-2



Part Number	 Hose I.D.				 Flange	A	B	E
	DN	Inch	Size	mm	Inch	mm	mm	mm
KX9V6-20-20	31	1 1/4	-20	31.8	1 1/4	176.8	85.5	90
KX9V6-24-24	38	1 1/2	-24	38.1	1 1/2	209.3	113	104
KX9V6-32-32	51	2	-32	50.8	2	268	157	138

Approved **fitting series** for **hose types**, depending on size: Also available in stainless steel. Details can be found in CAT 4400.1/UK

V4	H31	H31TC	H31ST	R42	R42TC	R42ST	R35	R35TC	RS35TC	R50TC	H29	H29TC	H29ST	FA35
V6	R35	R35TC	RD35TC	RS35TC	R42	R42ST	R42TC	R50TC	FA35	CEM69TC				

XA Caterpillar® Flange Straight

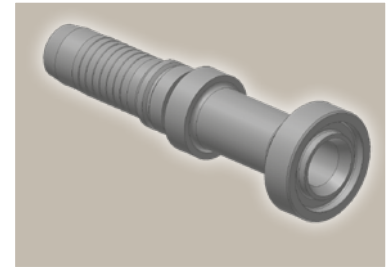
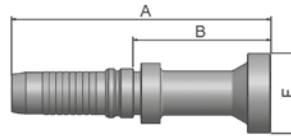

Part Number	Hose I.D.				Flange Inch	A mm	B mm	F mm
	DN	Inch	Size	mm				
KXAV4-12-12	19	3/4	-12	19.1	3/4	132	71	41
KXAV4-16-12	19	3/4	-12	19.1	1	144	82	48
KXAV4-16-16	25	1	-16	25.4	1	155	82	48
KXAV4-20-16	25	1	-16	25.4	1 1/4	160	88	54
KXAV6-20-20	31	1 1/4	-20	31.8	1 1/4	181	90	54
KXAV6-24-20	31	1 1/4	-20	31.8	1 1/2	188	97	64
KXAV6-24-24	38	1 1/2	-24	38.1	1 1/2	207	111	64

XF Caterpillar® Flange 45° Elbow

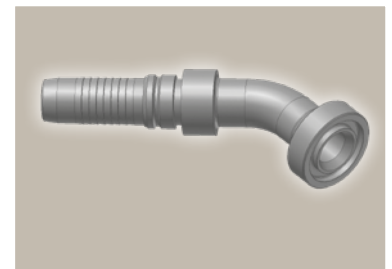
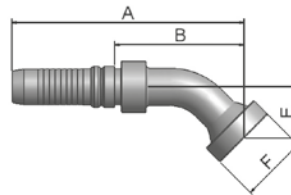

Part Number	Hose I.D.				Flange Inch	A mm	B mm	E mm	F mm
	DN	Inch	Size	mm					
KXFV4-12-12	19	3/4	-12	19.1	3/4	138	76	31	41
KXFV4-16-16	25	1	-16	25.4	1	164	91	36	48
KXFV4-20-16	25	1	-16	25.4	1 1/4	164	92	35	54
KXFV6-20-20	31	1 1/4	-20	31.8	1 1/4	187	96	37	54
KXFV6-24-20	31	1 1/4	-20	31.8	1 1/2	187	96	37	64
KXFV6-24-24	38	1 1/2	-24	38.1	1 1/2	216	120	39	64

Approved **fitting series** for hose types, depending on size: Also available in stainless steel. Details can be found in CAT 4400.1/UK

V4	H31 H31TC H31ST R42 R42TC R42ST R35 R35TC RS35TC R50TC H29 H29TC H29ST FA35
V6	R35 R35TC RD35TC RS35TC R42 R42ST R42TC R50TC FA35 CEM69TC

XG Caterpillar® Flange
60° Elbow

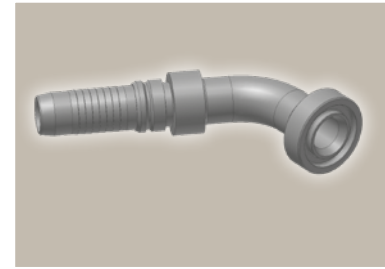
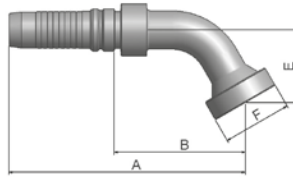

Part Number	Hose I.D.				Flange Inch	A mm	B mm	E mm	F mm
	DN	Inch	Size	mm					
KXGV4-16-12	19	3/4	-12	19.1	1	152	91	42	48
KXGV4-16-16	25	1	-16	25.4	1	182	109	50	48
KXGV4-20-16	25	1	-16	25.4	1 1/4	184	112	50	54
KXGV6-20-20	31	1 1/4	-20	31.8	1 1/4	206	115	55	54
KXGV6-24-20	31	1 1/4	-20	31.8	1 1/2	208	117	52	64
KXGV6-24-24	38	1 1/2	-24	38.1	1 1/2	266	170	52	64

XN Caterpillar® Flange
90° Elbow

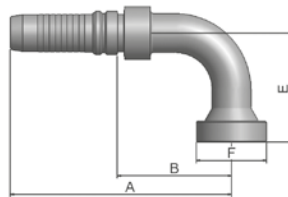

Part Number	Hose I.D.				Flange Inch	A mm	B mm	E mm	F mm
	DN	Inch	Size	mm					
KXNV4-12-12	19	3/4	-12	19.1	3/4	125	63	63	41
KXNV4-16-12	19	3/4	-12	19.1	1	125	63	62	48
KXNV4-16-16	25	1	-16	25.4	1	150	77	74	48
KXNV4-20-16	25	1	-16	25.4	1 1/4	154	81	74	54
KXNV6-20-20	31	1 1/4	-20	31.8	1 1/4	177	86	77	54
KXNV6-24-20	31	1 1/4	-20	31.8	1 1/2	177	86	77	64
KXNV6-24-24	38	1 1/2	-24	38.1	1 1/2	209	113	106	64

Approved **fitting series** for **hose types**, depending on size: Also available in stainless steel. Details can be found in CAT 4400.1/UK

V4	H31	H31TC	H31ST	R42	R42TC	R42ST	R35	R35TC	RS35TC	R50TC	H29	H29TC	H29ST	FA35
V6	R35	R35TC	RD35TC	RS35TC	R42	R42ST	R42TC	R50TC	FA35	CEM69TC				

JC

Female ORFS Swivel – Straight Short

ISO 12151-1 – SWSA
SAE J516 – ORFS

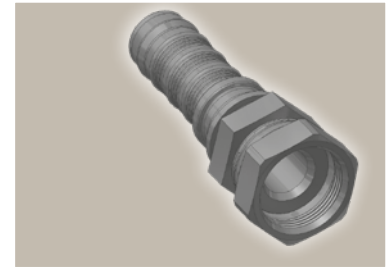
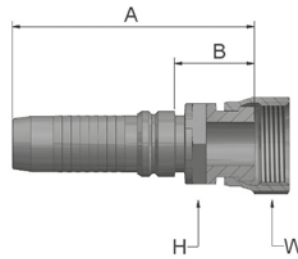

Part Number	Hose I.D.				Thread UNF	A mm	B mm	H mm	W mm
	DN	Inch	Size	mm					
KJCV4-12-12	19	3/4	-12	19.1	1 3/16x12	93	31.3	30	36
KJCV4-16-12	19	3/4	-12	19.1	1 7/16x12	93	31	36	41
KJCV4-12-16	25	1	-16	25.4	1 3/16x12	101	29	36	36
KJCV4-16-16	25	1	-16	25.4	1 7/16x12	108	36	36	41
KJCV4-20-16	25	1	-16	25.4	1 11/16x12	120	47	41	50
KJCV4-20-20	31	1 1/4	-20	31.8	1 11/16x12	127	39	46	50
KJCV6-20-20	31	1 1/4	-20	31.8	1 11/16x12	132	41	46	50
KJCV6-24-20	31	1 1/4	-20	31.8	2x12	133	42	50	60
KJCV4-24-24	38	1 1/2	-24	38.1	2x12	131	37.9	50	60
KJCV6-24-24	38	1 1/2	-24	38.1	2x12	140	44	50	60

JS

ORFS Swivel Female (Long)

ISO 12151-1-SWSB
SAE J516 – ORFS

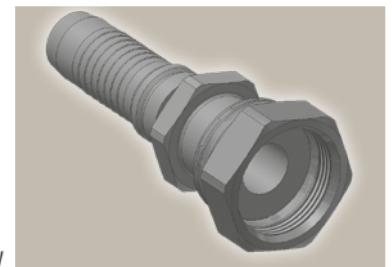
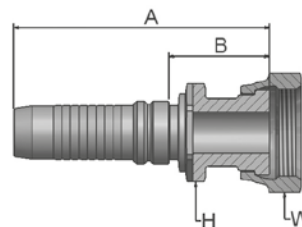

Part Number	Hose I.D.				Thread UNF	A mm	B mm	H mm	W mm
	DN	Inch	Size	mm					
KJSV4-16-16	25	1	-16	25.4	1 7/16x12	121	49	36	41
KJSV4-20-16	25	1	-16	25.4	1 11/16x12	120	47.7	41	50
KJSV4-20-20	31	1 1/4	-20	31.8	1 11/16x12	137	49.7	41	50

Approved **fitting series** for hose types, depending on size: Also available in stainless steel. Details can be found in CAT 4400.1/UK

V4	H31	H31TC	H31ST	R42	R42TC	R42ST	R35	R35TC	RS35TC	R50TC	H29	H29TC	H29ST	FA35
V6	R35	R35TC	RD35TC	RS35TC	R42	R42ST	R42TC	R50TC	FA35	CEM69TC				

J7 Female ORFS – Swivel 45° Elbow

ISO 12151-1 – SWE 45°
SAE J516 – ORFS 45°

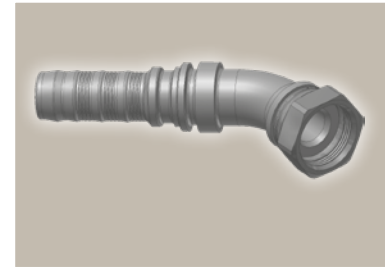
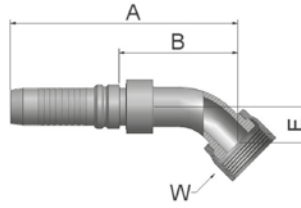

Part Number	Hose I.D.				Thread UNF	A mm	B mm	E mm	W mm
	DN	Inch	Size	mm					
KJ7V4-12-12	19	3/4	-12	19.1	1 3/16x12	128	66.3	21	36
KJ7V4-16-12	19	3/4	-12	19.1	1 7/16x12	131	70	24	41
KJ7V4-16-16	25	1	-16	25.4	1 7/16x12	152	79	24	41
KJ7V4-20-16	25	1	-16	25.4	1 11/16x12	154	81	26	50
KJ7V4-20-20	31	1 1/4	-20	31.8	1 11/16x12	189	101.7	30	50
KJ7V6-20-20	31	1 1/4	-20	31.8	1 11/16x12	179	87.8	33	50
KJ7V6-24-20	31	1 1/4	-20	31.8	2x12	190	99	40	60
KJ7V4-24-24	38	1 1/2	-24	38.1	2x12	218	124.9	40	60
KJ7V6-24-24	38	1 1/2	-24	38.1	2x12	216	120	40	60

J9 Female ORFS – Swivel 90° Elbow – Short Drop

ISO 12151-1 – SWES
SAE J516 – ORFS 90°

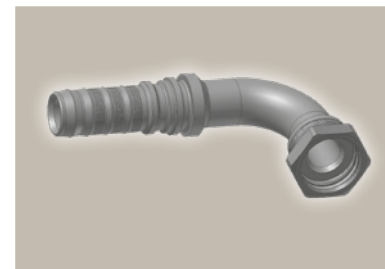
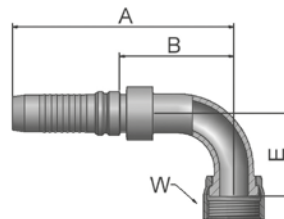

Part Number	Hose I.D.				Thread UNF	A mm	B mm	E mm	W mm
	DN	Inch	Size	mm					
KJ9V4-12-12	19	3/4	-12	19.1	1 3/16x12	125	63.3	48	36
KJ9V4-16-12	19	3/4	-12	19.1	1 7/16x12	125	63	56	41
KJ9V4-16-16	25	1	-16	25.4	1 7/16x12	150	77.7	56	41
KJ9V4-20-16	25	1	-16	25.4	1 11/16x12	150	77	64	50
KJ9V4-20-20	31	1 1/4	-20	31.8	1 11/16x12	186	98	69	50
KJ9V6-20-20	31	1 1/4	-20	31.8	1 11/16x12	177	86	79	50
KJ9V6-24-20	31	1 1/4	-20	31.8	2x12	177	86	70	60
KJ9V4-24-24	38	1 1/2	-24	38.1	2x12	210	116.9	82	60
KJ9V6-24-24	38	1 1/2	-24	38.1	2x12	202	106	87	60

Approved **fitting series** for **hose types**, depending on size: Also available in stainless steel. Details can be found in CAT 4400.1/UK

V4	H31	H31TC	H31ST	R42	R42TC	R42ST	R35	R35TC	RS35TC	R50TC	H29	H29TC	H29ST	FA35
V6	R35	R35TC	RD35TC	RS35TC	R42	R42ST	R42TC	R50TC	FA35	CEM69TC				

JM

ORFS Male

ISO 12151-1-S – SAE J516

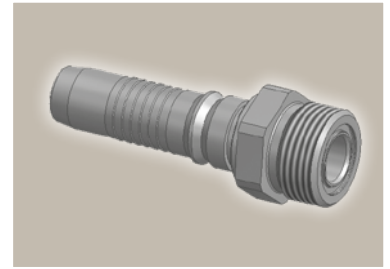
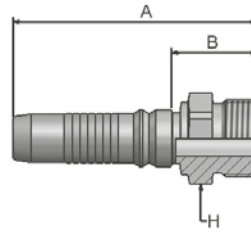

Part Number	Hose I.D.				Thread UNF	A mm	B mm	H mm
	DN	Inch	Size	mm				
KJMV4-12-12	19	3/4	-12	19.1	1 3/16x12	95	33.3	32
KJMV4-16-12	19	3/4	-12	19.1	1 7/16x12	98.7	37	41

V4/V6 Series

Approved **fitting series** for hose types, depending on size: Also available in stainless steel. Details can be found in CAT 4400.1/UK

V4	H31	H31TC	H31ST	R42	R42TC	R42ST	R35	R35TC	RS35TC	R50TC	H29	H29TC	H29ST	FA35
V6	R35	R35TC	RD35TC	RS35TC	R42	R42ST	R42TC	R50TC	FA35	CEM69TC				

Shell

Page Dg-1

V5

Dg-1

**Interlock
In-/Outside Skive**
R56TC Hose

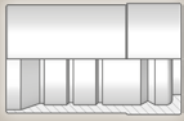

DIN – Metric

Page Dg-2 – Dg-3

C9

Dg-2

**Female Metric 24° – Swivel
Heavy Series with O-Ring
Straight**
ISO 12151-2-SWS-S – DKOS

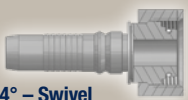

0C

Dg-2

**Female Metric 24° – Swivel
Heavy Series with O-Ring
45° Elbow**
ISO 12151-2 – SWE-S – DKOS 45°

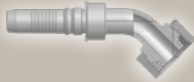

1C

Dg-3

**Female Metric 24° – Swivel
Heavy Series with O-Ring
90° Elbow**
ISO 12151-2-SWE-S – DKOS 90°



V5

Interlock In-/Outside Skive

R56TC Hose

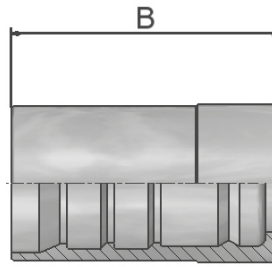

**Only for use with
adjustable crimpers.**

Part Number	 Hose I.D.				B mm
	DN	Inch	Size	mm	
100V5-6	10	3/8	-6	9.5	47
100V5-8	12	1/2	-8	12.7	53

Approved **fitting series** for hose types:



C9 Female Metric 24° – Swivel Heavy Series with O-Ring Straight

ISO 12151-2-SWS-S – DKOS

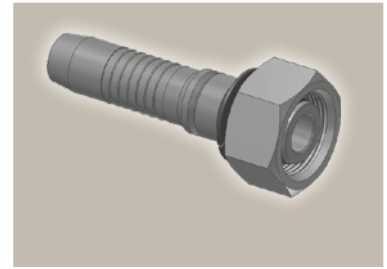
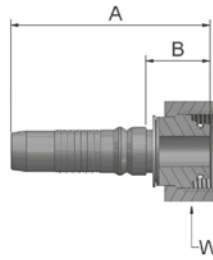

Part Number	Hose I.D.				Thread metric	Tube O.D. mm	A mm	B mm	W mm
	DN	Inch	Size	mm					
KC9V5-14-6	10	3/8	-6	9.5	M22x1.5	14	69	23	27
KC9V5-16-8	12	1/2	-8	12.7	M24x1.5	16	79	26	30

Fittings with standard O-ring seals can be used for temperatures from -40 °C up to +105 °C.
O-rings see section Eb. Special O-rings are available on request.

OC Female Metric 24° – Swivel Heavy Series with O-Ring 45° Elbow

ISO 12151-2 – SWE -S – DKOS 45°

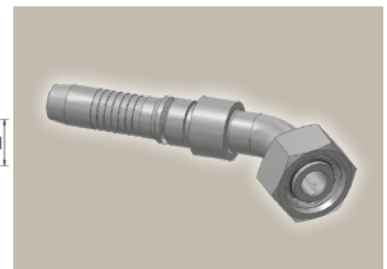
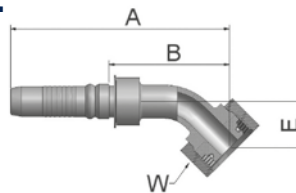

Part Number	Hose I.D.				Thread metric	Tube O.D. mm	A mm	B mm	E mm	W mm
	DN	Inch	Size	mm						
KOCV5-14-6	10	3/8	-6	9.5	M22x1.5	14	102	53	20	27
KOCV5-16-8	12	1/2	-8	12.7	M24x1.5	16	112	60	24	30

Fittings with standard O-ring seals can be used for temperatures from -40 °C up to +105 °C.
O-rings see section Eb. Special O-rings are available on request.

Approved **fitting series** for hose types:

V5 R56TC

1C Female Metric 24° – Swivel Heavy Series with O-Ring 90° Elbow

ISO 12151-2-SWE-S – DKOS 90°

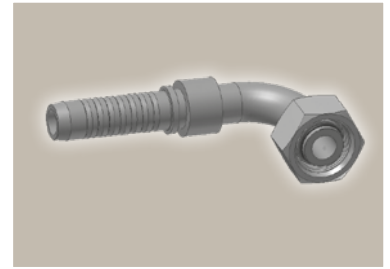
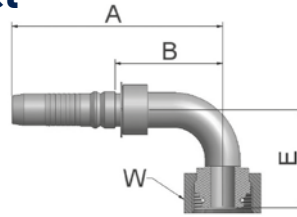

Part Number	Hose I.D.				Thread metric	Tube O.D. mm	A mm	B mm	E mm	W mm
	DN	Inch	Size	mm						
K1CV5-14-6	10	3/8	-6	9.5	M22x1.5	14	91	42	37	27
K1CV5-16-8	12	1/2	-8	12.7	M24x1.5	16	101	48	45	30

Fittings with standard O-ring seals can be used for temperatures from -40 °C up to +105 °C.
O-rings see section Eb. Special O-rings are available on request.

Approved **fitting series** for hose types:



Shell

Page Dh-1

100WB

Dh-1

**Interlock
In-/Outside Skive**
BPK Hose



DIN – Metric

Page Dh-2

C9

Dh-2

**Female Metric 24° – Swivel
Heavy Series with O-Ring
Straight**
ISO 12151-2-SWS-S – DKOS



BSP

Page Dh-3

92

Dh-3

**Female BSP Parallel Pipe
Swivel – Straight (60° Cone)**
BS5200-A – DKR

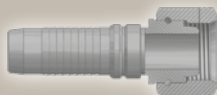

SAE

Page Dh-4

01

Dh-4

**Male NPTF Pipe
Rigid – Straight**
SAE J476A / J516 – AGN

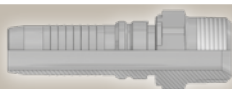

100WB Interlock
In-/Outside Skive
BPK Hose

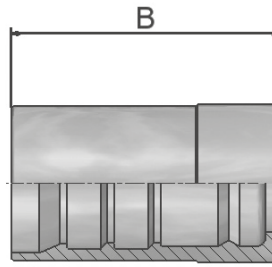

Only for use with adjustable crimpers.

Part Number	 Hose I.D.				B mm
	DN	Inch	Size	mm	
100WB-6	10	3/8	-6	9.5	47.0
100WB-8	12	1/2	-8	12.7	52.5
100WB-12	19	3/4	-12	19.1	61.0
100WB-16	25	1	-16	25.4	74.5

WB Series

Approved **fitting series** for hose types:



C9 Female Metric 24° – Swivel Heavy Series with O-Ring Straight

ISO 12151-2-SWS-S – DKOS

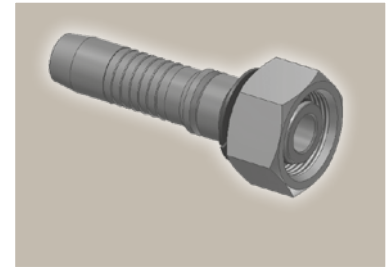
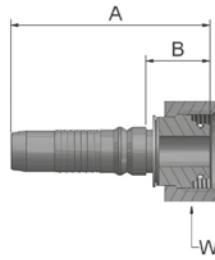

Part Number	Hose I.D.				Thread metric	Tube O.D. mm	A mm	B mm	W mm
	DN	Inch	Size	mm					
KC9WB-14-6	10	3/8	-6	9.5	M22x1.5	14	72	23	27
KC9WB-16-8	12	1/2	-8	12.7	M24x1.5	16	85	32	30
KC9WB-25-12	19	3/4	-12	19.1	M36x2	25	95	34	46
KC9WB-30-16	25	1	-16	25.4	M42x2	30	108	36	50

Fittings with standard O-ring seals can be used for temperatures from -40 °C up to +105 °C.
O-rings see section Eb. Special O-rings are available on request.

Approved **fitting series** for hose types:

WB BPK

92 Female BSP Parallel Pipe Swivel – Straight (60° Cone)

BS5200-A – DKR

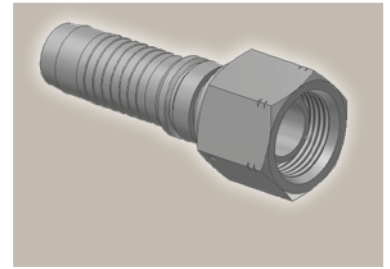
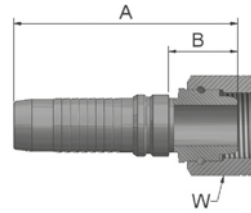

Part Number	Hose I.D.				Thread BSP	A mm	B mm	W mm
	DN	Inch	Size	mm				
K92WB-6-6	10	3/8	-6	9.5	3/8x19	72	23	22
K92WB-8-8	12	1/2	-8	12.7	1/2x14	79	26	27

Approved **fitting series** for hose types:



01

**Male NPTF Pipe
Rigid – Straight**

SAE J476A / J516 – AGN

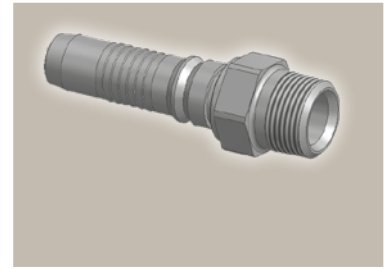
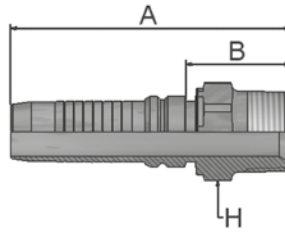

Part Number	Hose I.D.				Thread NPTF	A mm	B mm	H mm
	DN	Inch	Size	mm				
K01WB-6-6	10	3/8	-6	9.5	3/8-18	77	28	19
K01WB-8-8	12	1/2	-8	12.7	1/2-14	90	37	22
K01WB-12-12	19	3/4	-12	19.1	3/4-14	98	36	30
K01WB-16-16	25	1	-16	25.4	1-11 1/2	114	41	36

Approved **fitting series** for hose types:

WB BPK



Hydraulic Hoses, Fittings and Equipment

Machines, Tooling, Accessories



ENGINEERING YOUR SUCCESS.

Hydraulic Hose Assembly Workshop Equipment

– meeting the demands of professional
hose assembly manufacture

Hose assemblies must be manufactured in conformity with all the relevant EN/ISO standards and with the requirements of various work safety and trade associations. Hose Products Division Europe has selected and developed a complete range of machines and tooling to ensure effective and safe production of hose assemblies. This can be achieved only when equipment designed for the purpose is used.

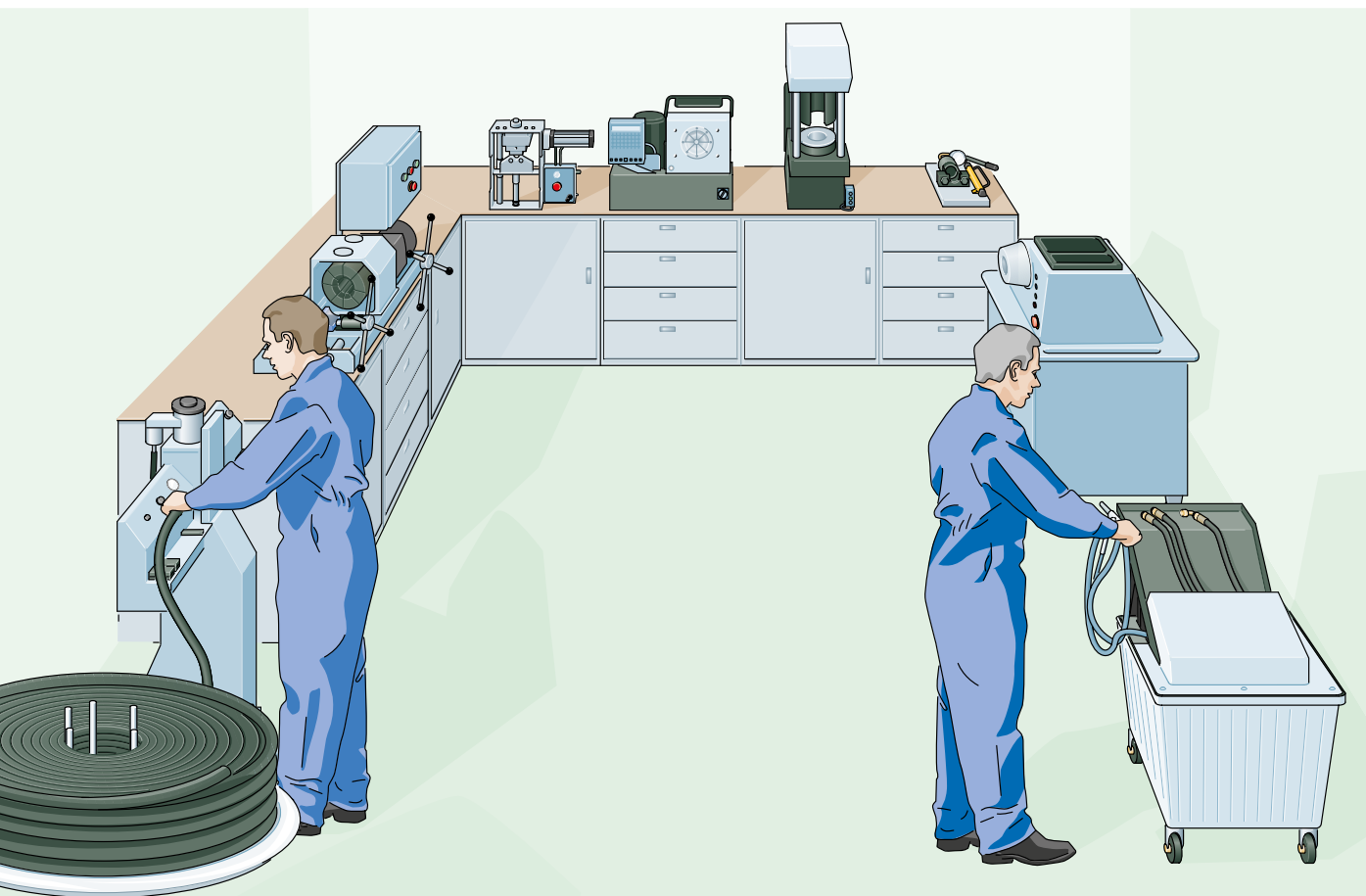

**The programme includes the right tools for
ready-to-install Parkrimp No-Skive
and ParLock hose assemblies:**

- Cutting hoses
- Crimping hoses
- Marking hose assemblies
- Cleaning hose assemblies
- Testing hose assemblies



TH 7-12
7-stage hose reel



85CE-061L + 85CE-1PE
KarryKrimp 2 Bench Mount



TH3E-EM6-M
Hose Cutting Machine



TH 5-3
Hose Assembly Test Bench



TH 4-4 U
Hand Marking Tools



TH 6-6
Cleaning System



TH8E-535-CM
Adjustable Crimper

**It's so easy to crimp
your own hose
assemblies**

Please visit us at
www.easy-crimping.com



Parkrimp® *No-Skive*

The system for fast and leak-free assemblies

Hose fittings have an impact on the overall efficiency and safety of a hydraulic system.

The No-Skive concept was launched by Parker Hannifin some 30 years ago but continuous development and the use of modern materials and production techniques have resulted in a state-of-the-art hose to fitting connection. Much easier handling and a high level of safety are available with No-Skive crimp fittings. Parker offers one piece No-Skive fittings as part of a package consisting of quality hose, No-Skive fittings, hose crimpers and tooling.



Parkrimp *No-Skive* one-piece fittings



Modular Design = Portable + Bench Mount Parkrimp crimpers for *No-Skive* one-piece fittings

The modular design enables the customer to choose between the portability that Parker KarryKrimp crimpers have always offered, and the option to make these same crimpers bench mount units.

The modular design gives users the flexibility of a portable crimper with the advantage of increased productivity when connected to the Bench Power Unit 85CE-1PE.



KarryKrimp® 1



KarryKrimp® 1
Bench Mount



KarryKrimp® 2



KarryKrimp® 2
Bench Mount

Parkrimp® *No-Skive*

- No skiving tool needed
- No need to remove the cover
- Crimps one-piece fittings
- Parkalign positions the fittings in the dies perfectly every time
- Quick and easy: no gauges to set on the machine
- Portable machines for field repair
- Meets EN safety regulations

ParLock Hose and Fittings

The high-performance skiving system

Certain customers and applications stipulate the usage of multispiral hose assemblies with external/internal skive-type fittings. With the ParLock hose and fitting range, Parker meets this demanding market requirement. Parker adjustable crimpers for two-piece fittings ensure precise, leak-free and tear-proof assembly of hose and fitting.

- High flex-impulse applications
- High vibration applications
- The ParLock design is approved by the German Accident Prevention & Insurance Association (Berufsgenossenschaft) conforming to EN 201 (approved for injection-moulding machine applications)

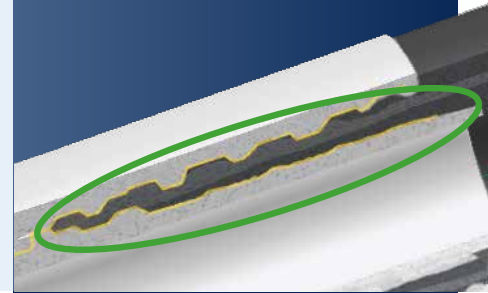

ParLock two-piece skive fittings



TH2-13-3PH
Hose skiving machine

Adjustable crimpers
for two-piece ParLock fittings



TH8E-530



TH 8E-380-CM



TH 8E-480-CM

ParLock System

- A full range of multispiral hoses to ISO 3862 (4SP to R15)
- Field-tested, proven reliability
- Hose and fitting combinations giving performance that exceeds ISO/EN requirements
- Approved hose and fitting compatibility “one manufacturer, one source”

Hose Whip Restraint

Safety Restraining System for Pressure Hoses

- Prevents whipping of a pressurized hose in the event of the hose separating from its fitting
- The system consists of two parts – a hose collar and a cable assembly



Parker's Hose Whip Restraint System is designed to prevent whipping of a pressurized hose in the event of the hose separating from its fitting. The Hose Whip Restraint System provides an additional level of safety and helps prevent damage to nearby equipment or injury to operators near the failed hose by limiting the whip or travel of the pressurized hose after it breaks free from its hose fitting. Serious damage or injury can occur from whipping hoses, especially at higher pressures.

The system consists of two parts – a hose collar and a cable assembly. The hose collar (WRCxx) is selected based on the outside diameter of the hose, and the cable assembly is selected based on the type of hose connection. Two types of cable assemblies are available – one for flange-type connections (WRFxxx), and the other for port adapters (WRAxxx).

The Hose Whip Restraint is not to be used in place of proper hose crimping procedures. Exceeding the maximum operating pressure of the hose jeopardizes the proper operation of the Hose Whip Restraint System.

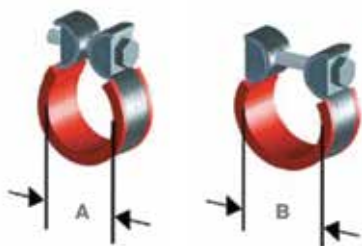

Hose collars
for Hose Whip Restraint System



Cable Assemblies
for hoses attached with port adapters



Cable Assemblies
for hoses using flange-style connections
ISO 6162-1 (35.0 MPa/5000 psi) and
ISO 6162-2 (42.0 MPa/ 6000 psi)

For more information about hose whip restraint please refer to page Eb-19.

Machines, Tooling, Accessories

Machines	
Parkrimp® Crimping Presses	Ea-1 – Ea-4
Accessories for Parkrimp® Crimping Presses	Ea-5
Parkrimp® Die Sets / Die Storage Racks	Ea-6
Hose Cutting Machines	Ea-7 – Ea-12
Marking Machines	Ea-13 – Ea-14
Cleaning Systems	Ea-15 – Ea-18
Hose Assembly Test Bench	Ea-19
Hose Reels	Ea-20 – Ea-21
Adjustable Crimping Presses	Ea-22 – Ea-26
Hose Skiving Machines	Ea-27 – Ea-29
Skiving Tools for Hose Skiving Machines	Ea-30
Clean Seal Capsules	Ea-31
Clean Seal Protection – Heat Shrink	Ea-32
Assembly and Hose Fitting Insertion Device	Ea-33
Accessories	
Flange Half	Eb-1
Bolts for Flange Halves ISO 6162-1 and ISO 6162-2	Eb-2 – Eb-3
Full Flange System	Eb-4
Bolts for Full Flange System	Eb-5
Banjo Bolt	Eb-6
O-Rings	Eb-7 – Eb-8
Worm Drive Hose Clamps	Eb-9 – Eb-10
Hose Protection	Eb-11 – Eb-21
Hose Whip Restraint	Eb-22
Containment Grips	Eb-23
Thread Identification Kit	Eb-23
Parker „Hoze-Oil“	Eb-24
OilOn	Eb-24
Push-Lok® Assembly Oil	Eb-24
Assembly Instructions	
KarryKrimp® 1 / KarryKrimp® 2	Ec-1
Parkrimp® 2	Ec-2
Your Crimp Source online	Ed-1

KarryKrimp® 1

Modular portable crimper for braided hoses

- Crimps
 - 1 and 2 steel wire or textile braided hoses..... size -4 up to size -20
- Available in modular design with all Parkrimp system advantages
- The same unit offers portability and bench mountability
- Easily portable for outside work
- Used for service with hand pump or airhydraulic and electrical pump
- Portable, compact rugged design
- Pivoting pusher design for easy die change out
- Increased height enables longer bent tube fittings to be crimped

Primary Applications

Small workshops, repair shops, mobile service vehicles.



Fitting Series

26, 43, 46, 48

Restrictions

Not suitable for multispiral hoses, 2-piece fittings, stainless steel fittings and serial production of hose assemblies in size -12 and above.

Technical / Order Data

KarryKrimp 1	Dimensions	H 760 x W 335 x D 330 mm
	Weight	28 kg
	Part Number	82CE-061L
Included standard equipment		
<i>Crimp head</i>	Part Number	82CE-CHD
<i>Stand assembly</i>	Part Number	85C-STD
<i>Hose assembly</i>	Part Number	85CE-00L
<i>Die rings</i>	silver	Part Number 82C-R01
	black	Part Number 82C-R02

Accessories see page **Ea-5**

KarryKrimp® 2

Modular portable crimper
for braided and multispiral hoses

- Crimps
 - 1 and 2 steel wire
or textile braided hoses up to size -20
 - 3 steel wire braided hoses up to size -16
 - 4 layer multispiral hoses up to size -16
 - compact spiral hoses up to size -12
- Available in modular design with
all Parkrimp system advantages
- The same unit offers portability and
bench mountability
- Easily portable for outside work
- Portable, compact rugged design
- Pivoting pusher design for easy die change out

Primary Applications

Small workshops, repair shops, mobile service vehicles.
Crimps both steel and stainless steel fittings.



Fitting Series

26, 43, 46, 48, 70, 73, 77

Restrictions

Not suitable for 2-piece fittings.

Technical / Order Data

KarryKrimp 2	Dimensions	H 805 x W 340 x D 350 mm
	Weight	46 kg
	Part Number	85CE-061L
Included standard equipment		
<i>Crimp head</i>	Part Number	85CE-CHD
<i>Stand assembly</i>	Part Number	85C-STD
<i>Hose assembly</i>	Part Number	85CE-00L
<i>Die rings</i>	silver	Part Number 85C-R01
	black	Part Number 85C-R02

Accessories see page **Ea-5**

KarryKrimp Bench Mount

Modular crimpers with Bench Power Unit for workshops

- In addition to the portable versions, the sole crimping units can be used with the Bench Power Unit for workshop versions
- Faster cycle times for increased productivity
- Increased height for longer elbows or bent tube fittings
- The crimpers and the Bench Power Unit are supplied separately



Modular Design = Portable + Bench Mount

The modular design enables the customer to choose between the portability that Parker KarryKrimp crimpers have always offered, and the option to make these same crimpers bench mount units.

The modular design gives users the flexibility of a portable crimper with the advantage of increased productivity when connected to the Bench Power Unit 85CE-1PE.



Technical / Order Data

**Bench Power Unit
85CE-1PE**



Working pressure	70 MPa
Dimensions	L 425 x W 525 x H 460 mm
Weight	62 kg
Usable oil capacity	8000 ccm
Electrical power	230 V / 50/60 Hz / 10 A
Part Number	85CE-1PE

Parkrimp® 2

Bench-mounted crimper for all Parkrimp *No-Slave* hose types from size -4 up to size -32, including 4 and 6 layer multispiral hoses

- Crimps
 - 1 and 2 steel wire or textile braided hoses up to size -32
 - 3 steel wire braided compact up to size -16
 - 4 and 6 layer multispiral hoses up to size -32
 - Compact Spiral hoses up to size -24 (Size -32 not recommended)
 - Stainless steel fitting series 77 up to size -24
- Used for service with 400 V hydraulic power unit

Primary Applications

Workshops and repair shops (for small series).
Crimps both steel and stainless steel fittings.



Fitting Series

26, 43, 46, 48, 70, 73, 77

Restrictions

Not suitable for 2-piece fittings.
For steel and stainless steel fittings series 77 size -32 only partially suitable.

Technical / Order Data

Parkrimp 2 with power unit, bench-mounted, but without die sets, connector plug and oil

Electrical power	400 V / 4.4 kW / 8.9 A / 50 Hz	
Dimensions	H 1170 x W 530 x D 985 mm	
Weight	without packaging	370 kg
	with packaging	430 kg
Part Number	83CE-083U	

Included standard equipment

<i>Adaptor bowl</i>	Part Number	83C-0CB
<i>Die ring</i>	Part Number	83C-R02
<i>Die plate</i>	Part Number	83C-R02H

Accessories for KarryKrimp® 1 and KarryKrimp® 2

For use with Karrykrimp 1 crimping press

Hand pump
82C-2HP



Working pressure	max. 70 MPa
Dimensions	L 530 x W 121 x H 178 mm
Weight	4.1 kg
Usable oil capacity	900 ccm
Lever force	42 kg
Part Number	82C-2HP

For use with KarryKrimp 1 and KarryKrimp 2 crimping presses

Hand pump
85CE-0HP



Working pressure	max. 70 MPa
Dimensions	L 580 x W 150 x H 195 mm
Weight	10.7 kg
Usable oil capacity	2200 ccm
Lever force	35 kg
Part Number	85CE-0HP

Turbo air pump
85C-0AP



Working pressure	70 MPa
Dimensions	L 350 x W 170 x H 210 mm
Weight	8.2 kg
Usable oil capacity	2080 ccm
Connection	air 1/4-18 NPTF thread
Part Number	85C-0AP

Power pump
82CE-0EP



Working pressure	70 MPa with 3/2 hand valve
Dimensions	L 244 x W 244 x H 362 mm
Weight	10.0 kg
Usable oil capacity	1900 ccm
Connection	230 V / 50/60 Hz / 10 A
Part Number	82CE-0EP

Air Hydraulic pump
85CE-XAM

Optional: Manual lever
Part Number
85CE-XA-LK1



Working pressure	70 MPa
Dimensions	L 351 x W 260 x H 152 mm
Weight	8.8 kg
Usable oil capacity	1000 ccm
Connection	air: 1/4-18 NPTF female oil: 3/8-18 NPTF female; 90° swivel
Part Number	85CE-XAM

Bench Power Unit
85CE-1PE



Working pressure	70 MPa
Dimensions	L 425 x W 525 x H 460 mm
Weight	62 kg
Usable oil capacity	8000 ccm
Electrical power	230 V / 50/60 Hz / 10 A
Part Number	85CE-1PE

Hose Assemblies 82CE-00L (DN06)
resp. 85CE-00L (DN10)
Hose assembly to connect
pump to the press

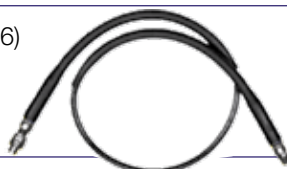

Working pressure	max. 70 MPa
Length	1830 mm
Port size	3/8-18 NPT male, coupling 3/8"
Part Number	82CE-00L resp. 85CE-00L

Parkrimp® Die Sets

Parker`s Colour-Coded Die Sets

- Chain link keeps segments together
- No loose parts to mismatch or misplace
- The crimp die provides 360-degree gripping power for greater impulse life



Hose I.D. size		Die sets	Part Number						
DN	26 series		43 series	46 series	48 series	70 series	73 series	77 series	
-4	6	red	80C-E04	80C-A04	80C-B04	80C-C04			
-5	8	violett	80C-E05	80C-A05	80C-B05	80C-C05			
-6	10	yellow	80C-E06	80C-A06	80C-B06	80C-C06	83C-D06		
-8	12	blue	80C-E08	80C-A08	80C-B08	80C-C08	83C-D08		80C-CS08
-10	16	orange	80C-E10	80C-A10	80C-B10	80C-C10	83C-D10		80C-CS10
-12	20	green	80C-E12	80C-A12	80C-B12	80C-C12	83C-D12	83C-L12 or 80C-L12	80C-CS12
-16	25	black	80C-E16	80C-A16 or 83C-A16H	80C-B16	80C-C16	83C-D16 or 83C-D16H	83C-L16 or 80C-L16	83C-CS16
-20	32	white	83C-E20	80C-A20 or 83C-A20H*	80C-B20	80C-C20 or 83C-C20H*		83C-L20	83C-CS20
-24	40	red	83C-E24	83C-A24		83C-C24		83C-L24	83C-CS24
-32	50	green	83C-E32	83C-A32		83C-C32		83C-L32	83C-CS32

Note: *Please consult the pages **Ec** for assembly instructions. Die sets with the "H" suffix are used for jump sizes and certain metric fittings to permit insertion and removal of fittings. Die sets 80C-XX 8 segments are chained together. Die sets 83C-XX consist of two chained halves. Exceptions 83C-D06, -D08, -D10, -D12, -D16

Die Storage Racks

- Modular die rack designed to hold small and large Parkrimp dies
- Can be bolted together to a work bench horizontally or vertically



Storage of three sets of small dies	Part Number	80C-0DR
Storage of two sets of large dies	Part Number	83C-0DR

EM 10.P

Hose Cutting Machine

- Cuts
 - 1 steel wire or textile braided hoses up to size -16
 - 2 steel wire braided hoses up to size -12
- Can be used on a workbench or in a vice bench
- Cutting blade covered during use
- Equipped with an electrical safety switch



Primary Applications

Repair shops or mobile service vehicles, preferably in combination with KarryKrimp 1

Restrictions

Not suitable for multispiral hoses or large bore industrial hoses.

Technical / Order Data

Hose Cutting Machine EM 10.P

with cutting blade, smooth TM 160 x 2,5 x 20

Electric motor	circular saw motor 230 V
Electric power	50/60 Hz / 1200 W / 6100 rpm
Electrical insulation	according VDE KI.II 0740
Radioshielding	according VDE 0875
Cutting blade	160 x 2.5 x 20 mm (HSS)
Dimensions	L 360 x W 340 x H 310 mm
Weight	8 kg
Part Number	EM 10.P
Part Number	TM 160 x 2,5 x 20

Cutting blade, smooth

TH 3-2-12VDC

Hose Cutting Machine

- Cuts
 - 1 and 2 steel wire or textile braided hoses up to size -20
 - 4 steel wire multispiral hoses up to size -16
- For mobile service vehicles with 12 V connection

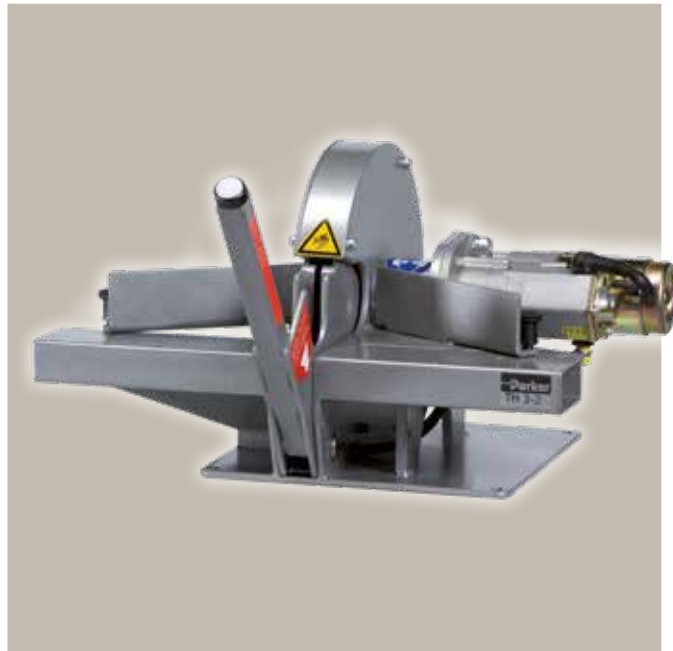

Primary Applications

Mobile service vehicles

Restrictions

Not suitable for large bore hoses.

Technical / Order Data

Hose Cutting Machine TH 3-2-12VDC
with cutting blade, serrated

Cutting blade, serrated 250 x 2 x 40 mm

Electric motor	12 V / 2.0 kW
Cutting blade	250 x 2 x 40 mm
Dimensions	W 567 x D 470 x H 365 mm
Weight	30 kg
Part Number	TH3-2-12VDC
Part Number	TM250x2x40Z

*Electric motor 24 V / 3.2 kW available on request

TH 3E-EM3

Hose Cutting Machine

- Cuts
 - 1 and 2 steel wire or textile braided hoses up to size -20
 - 4 steel wire multispiral hoses up to size -20
 - Industrial hoses up to size -32
- According to the CE safety standards the blade stops within 10 seconds after switching off the brake motor
- Faster and safer cut using less energy, cutting motor with a larger shaft oversize bearing to guarantee less vibration created by radial forces
- Cutting blades approved on considered material



Primary Applications

Repair shops or mobile service vehicles

Restrictions

Not suitable for large bore industrial hoses.

Technical / Order Data

Hose Cutting Machine TH 3E-EM3

with cutting blade, serrated TMG275x3x30

Cutting blade, serrated 275 x 3 x 30 mm

Electrical power	400V/ 3kW / 50Hz
Cutting blade	275 x 3 x 30 mm
Dimensions	W 540 x D 440 x H 300 mm
Weight	50 kg
Part Number	TH 3E-EM3
Part Number	TMG275x3x30

TH 3E-EM6-M

TH3E-EM6-P

Hose Cutting Machines

- Cuts
 - 1 and 2 steel wire or textile braided hoses up to size -32
 - Compact Spiral hoses up to size -20
 - 6 steel wire multispiral hoses up to size -32
- According to the CE safety standards the blade stops within 10 seconds after switching off the brake motor
- Faster and safer cut using less energy, cutting motor with a larger shaft oversize bearing to guarantee less vibration created by radial forces
- Cutting blades approved on considered material

Primary Applications

Service in hose workshops and for small series production

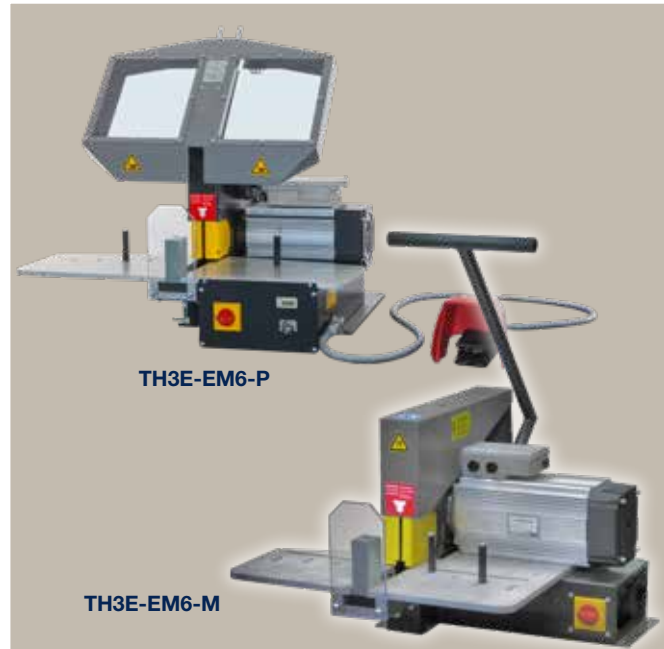

Restrictions

Cutting 6 layer multispiral hoses will reduce the service life of the blade.

Technical / Order Data

Hose Cutting Machine TH 3E-EM6-M with cutting blade, serrated TMG350x3x30	Electrical power	400 V / 4.6 kW / 50 Hz
	Exhaust system Ø	60 mm
	Cutting blade	350 x 3 x 30 mm
	Dimensions	L 745 x W 690 x H 430 mm
	Weight	75 kg
Part Number	TH3E-EM6-M	
Cutting blade, serrated 350 x 3 x 30 mm	Part Number	TMG350x3x30
Hose Cutting Machine TH 3E-EM6-P with pneumatic feed with cutting blade, serrated TMG 350x3x30	Electrical power	400 V / 4,6 kW / 50 Hz
	Exhaust system Ø	60 mm
	Cutting blade	350 x 3 x 30 mm
	Dimensions	L 820 x B 785 x H 755 mm
	Weight	110 kg
Part Number	TH3E-EM6-P	
Cutting blade, serrated 350 x 3 x 30 mm	Part Number	TMG350x3x30

TH 3E-115

Hose Cutting Machine

- Cuts
 - all industrial hose types up to 75 mm O.D.
 - 1, 2 and 3 steel wire or textile braided hoses..... up to size -40
 - 4/6 steel wire multispiral hoses up to size -32
- According to the CE safety standards the blade stops within 10 seconds after switching off the brake motor
- Faster and safer cut using less energy, cutting motor with a larger shaft oversize bearing to guarantee less vibration created by radial forces
- Cutting blades approved on considered material
- Easiest cutting of big dimensioned hoses with more energy efficient machines



Primary Applications

Service and series production at workshops.

Technical / Order Data

Hose Cutting Machine TH 3E-115 with cutting blade, coated TMC520x4x40	Electrical power	400 V / 7.5 kW / 25 A / 50 Hz
	Exhaust system Ø	100 mm
	Cutting blade	520 x 4 x 40 mm
	Dimensions	L 1210 x W 650 x H 1650 mm
	Weight	245 kg
	Part Number	TH3E-115
Cutting blade , coated 520 x 4 x 40 mm	Part Number	TMC520x4x40

TH 3E-110

Hose Cutting Machine

- Cuts
 - 1 and 2 steel wire or textile braided hoses up to size -48
 - 4 steel wire multispiral hoses up to size -48
 - 6 steel wire multispiral hoses up to size -48
 - Industrial hoses up to size -64
- According to the CE safety standards the blade stops within 10 seconds after switching off the brake motor
- Faster and safer cut using less energy, cutting motor with a larger shaft oversize bearing to guarantee less vibration created by radial forces
- Cutting blades approved on considered material
- Easiest cutting of big dimensioned hoses with more energy efficient machines



Primary Applications

Service and series production at workshops

Technical / Order Data

	Electrical power	400 V / 7.5 kW / 25 A / 50 Hz
	Exhaust system Ø	100 mm
	Cutting blade	520 x 4 x 40
	Dimensions	W 800 x D 780 x H 1700 mm
	Weight	280 kg
	Part Number	TH3E-110
Hose Cutting Machine TH 3E-110 with cutting blade, coated TMC520x4x40	Part Number	TMC520x4x40
Cutting blade, coated 520 x 4 x 40 mm		

TH 4-7, TH 4-8

Marking Machines

- Manually or pneumatically driven
- Suitable for marking all 1- and 2-piece fittings series up to size -32

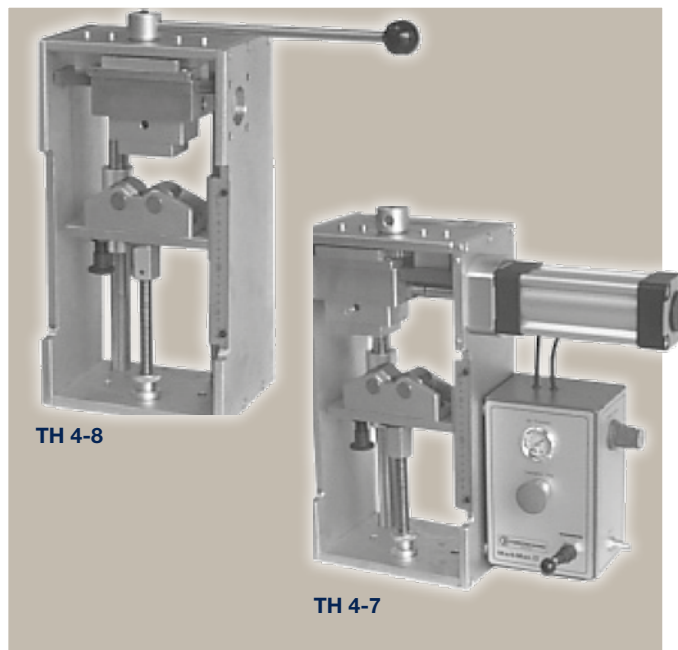

Primary Applications

Smaller workshops and mobile service vehicles

Technical / Order Data

Marking Machine TH 4-8 manual excl. QC-adapter, type case and type holder	Colour	zinc plated
	Dimensions	L 500 x W 200 x H 500 mm
	Weight	28 kg
Marking Machine TH 4-7 pneumatic excl. QC-adapter, type case and type holder	Part Number	TH4-8
	Colour	zinc plated
	Air pressure	min. 0.6 MPa
Type case 3 mm	Dimensions	L 500 x W 380 x H 500 mm
	Weight	35 kg
	Part Number	TH4-7
Type print holder 2 lines	Part Number	TH4-9
QC-adapter for type print holder	Part Number	TH4-9-1
	Part Number	TH4-10

Type holder
2 lines

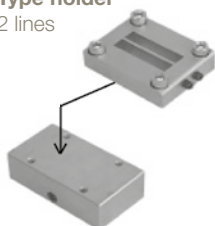

QC-adapter



Type case

Type case TH 4-9 content

AAABBCCDDDEEEFFGGHHIIJJKK
LLLMMNNNOOOOPPQQRRRSSSTT
UUUVVWXYZ//...,11112222333344
44556667778889990000 and 20 pcs of blanks

TH 4-4 U

Hand Marking Tools

- Hand marking tool for marking the crimp shells of 1- and 2-piece fittings up to size -32
- Permanent and easy marking in hose assembling workshops
- Type holder with two lines makes it possible to print additional information on the shell or fittings



Primary Applications

Workshops and mobile service vehicles

Technical / Order Data

Hand Marking Tool TH 4-4 U including type case and quick-change stamping tool	Marking area	Ø O.D. 11.5 mm - 100 mm
	Dimensions	L 250 x W 340 x H 450 mm
	Type holder	2 lines
	Weight	35 kg
Type case for TH 4-4 U	Part Number	TH4-4U
Quick-change stamping tool for TH 4-4 U single line	Part Number	UPTS 100
Type holder for TH 4-4 U 2 lines	Part Number	UPTH-11b-PW3
	Part Number	UPTH-22b

Stamping tool
UPTH-11b-PW3



Type case UPTS 100 content

Letters: 1x P, 1x N, 3x letters empty
 Numbers: 6 x 1; 5 x 2,3,4,5; 4 x 6; 3 x 7,8,9; 4 x 0
 Neutral: 1x 15 mm, 1x 30 mm + brush, tweezers, key

TH 6-6

Cleaning System

- Cleaning device for hose and hose assemblies for hoses up to size -20
- Assemblies flushed with fluid and blown out with air
- Defined cleanliness levels can be achieved
- Air connection min. 0.7 MPa required

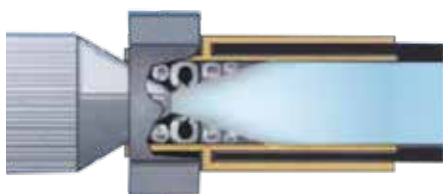

Technical / Order Data

	Air pressure	min. 0.7 MPa
	Flow	25 l/min
	Air consumption	max. 100 NI/min
	Length	(depending on I.D.) max. 2.5 m
	Dimensions	L 960 x W 435 x H 940 mm
	Weight	55 kg
	with cleaning fluid	93 kg
Cleaning Machine TH 6-6	Part Number	TH6-6
Filter set without cartridges	Part Number	H899959
Filter cartridges 5 µm	Part Number	600.4
Neutral cleaning fluid additive (30 litre drum)	Part Number	H899771

TH 6-7

Cleaning System

- Quick and simple system using compressed air to clean hoses
- Delivered with two plastic nozzles for hoses fromsize -4 up to -32

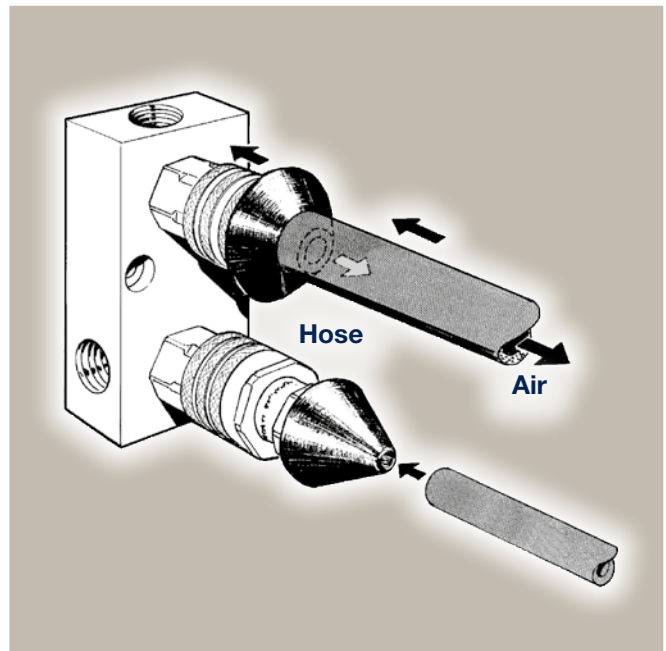

Primary Applications

The hose is pressed against the nozzle and thereby opens a valve to allow the compressed air to blow through the hose and blow out loose particles.

Technical / Order Data

Cleaning System TH 6-7

with two plastic nozzles in 30 and 55 mm

Air pressure	min. 0.6 MPa
Air connection	1/2" BSP
Dimensions	L 120 x W 50 x H 100 mm
Weight	0.3 kg
Part Number	TH6-7
Nozzle 30 mm	Part Number TH6-7-30
Nozzle 55 mm	Part Number TH6-7-55

TH 6-10-EL-8

Ultra Clean Kit

- Cleaning of hoses from size -4 up to -20
- Reduces downtime and risk of hose failure
- Has a quarter-turn locking ring for easy nozzle change and projectile loading
- Durable brass and aluminium internals, strong plastic handle, and anodized aluminium firing head and locking ring



Economy Kit
TH6-10-EL-8

Primary Applications

Workshops and mobile service vehicles

Restrictions

5 micron filter and regulator with gauge are strongly suggested

Technical / Order Data

Ultra Clean Kit TH 6-10-EL-8 with case, launcher in size -20, nozzles in size -4, -5, -6, -8, -10, -12, -16 and -20 (1 each)

Air pressure	min. 0.55 MPa max. 0.75 MPa
Air connection	1/2" I.D. air hose
Dimensions	L 407 x W 134 x H 343 mm
Weight	4 kg
Part Number	TH6-10-EL-8

Nozzles and Projectiles for Ultra Clean Kit TH6-10-EL-8

Hose Size	Nozzle Part Number	Projectile Part Number
-4	TH6-10-H06	TH6-10-P10
-5	TH6-10-H08	TH6-10-P12
-6	TH6-10-H10	TH6-10-P14
-8	TH6-10-H13	TH6-10-P18
-10	TH6-10-H16	TH6-10-P22
-12	TH6-10-H19	TH6-10-P26
-16	TH6-10-H25	TH6-10-P33
-20	TH6-10-H32	TH6-10-P40

TH 6-10-HL-10-2

Ultra Clean Kit

- Cleaning of hoses from size -4 up to -32
- Reduces downtime and risk of hose failure
- Full-flow quick release coupling and unique 360° rotary plug for proper air flow and non-fatigue operator use
- Aluminium, fully anodized for harsh environments and heavy use
- Unique safety release bar that locks the faceplate into a closed position for firing Ultra Clean projectiles



Primary Applications

Workshops and mobile service vehicles

Restrictions

5 micron filter and regulator with gauge are strongly suggested

Technical / Order Data

Ultra Clean Kit TH 6-10-HL-10-2 with case, launcher in size -32, nozzles in size -4, -5, -6, -8, -10, -12, -16, -20, -24 and -32 (1 each)

Air pressure	min. 0.55 MPa max. 0.75 MPa
Air connection	1/2" I.D. air hose
Dimensions	L 407 x W 134 x H 343 mm
Weight	5 kg
Part Number	TH6-10-HL-10-2

Nozzles and Projectiles for Ultra Clean Kit TH6-10-HL-10-2

Hose Size	Nozzle Part Number	Projectile Part Number
-4	TH6-10-H06	TH6-10-P10
-5	TH6-10-H08	TH6-10-P12
-6	TH6-10-H10	TH6-10-P14
-8	TH6-10-H13	TH6-10-P18
-10	TH6-10-H16	TH6-10-P22
-12	TH6-10-H19	TH6-10-P26
-16	TH6-10-H25	TH6-10-P33
-20	TH6-10-H32	TH6-10-P40
-24	TH6-10-H38	TH6-10-P50
-32	TH6-10-H50	TH6-10-P60

TH 5-3

Hose Assembly Test Bench up to 145.0 MPa

- Totally sealed test chamber
- Safety interlock – pressure automatically decreases within 1/10 sec. when the test chamber is opened
- Rapid fill and automatic air bleeding of the test piece
- Weight-compensated protection cover with safety windows
- Bio-degradable water-oil emulsion as test medium
- Simple operation



Primary Applications

Service and series production in workshops. The hose assembly test bench makes the efficient and safe final inspection of hose assemblies practical and fast. Static pressure testing of other hydraulic components is also possible.

Restrictions

This test bench is not designed for burst pressure testing. Due to the limited flexibility of large bore multispiral hoses it is not ideal for size -24 and size -32 pressure testing.

Technical / Order Data

Hose Assembly Test Bench TH 5-3 incl. HD adapter set

Test pressure	12.0 - 145.0 MPa	
Drive	intensifier	
Compressed air rating	0.7 MPa, 20 NI/min	
Pressure regulator	manual	
Test medium	water-oil emulsion	
Safety control unit	yes	
Tank capacity	100 l	
Colour	black / silver	
Dimensions	L 2210 x W 840 x H 1260 mm	
Weight	empty	210 kg
	with medium	310 kg
Accessories	filter 100 µm, air service unit	
Part Number	TH5-3	

Hose Assembly Test Bench TH 5-3-BM with result recording unit

Part Number	TH5-3-BM
--------------------	-----------------

HD adapter set

Part Number	405.906
--------------------	----------------

Corrosion protection, 20 l

Part Number	H899770
--------------------	----------------

TH 7-12

7-stage hose reel

- Seven-stage reel for hoses from size -4 up to -20
- Every stage (except bottom stage) can be swung out horizontally so that new rolls can easily be inserted



Technical / Order Data

Hose Reel TH 7-12

for service and series production in workshops

Reel dimensions	
Int. Ø min. / max.	250 mm / 1010 mm
Height max.	300 mm
Max. load per reel	80 kg
Colour	zinc plated
Dimensions	L 1270 x W 1000 x H 2230 mm
Weight	148 kg
Part Number	TH7-12

TH 7-13

1-stage hose reel

- One-stage reel for hoses from size -4 up to -32
- Table adjustable to fit the center of the coil



Technical / Order Data

Hose Reel TH 7-13

for service and series production in workshops

Reel dimensions	
Int. Ø min. / max.	adjustable 150 - 500 mm
Max. load of reel	500 kg
Colour	zinc plated / grey
Dimensions	L 1200 x W 1200 x H 830 mm
Weight	40 kg
Part Number	TH7-13

TH 7-14

Horizontal motorized hose reel

- Motorized reel for hoses from size -4 up to -32
- Variable speed control in both directions
- Ideal for cutting long lengths where coiling is necessary

Technical / Order Data



Hose Reel TH 7-14

for service and series production in workshops

Reel dimensions	
Int. Ø min. / max.	adjustable 150 - 500 mm
Max. load of reel	500 kg
Electric power	230 V / 10 A / 50 Hz
Colour	zinc plated / light grey
Dimensions	W 1200 x H 830 mm
Weight	65 kg
Part Number	TH7-14

TH 7-15

Vertical motorized hose reel

- Motorized reel for hoses from size -4 up to -20
- Variable speed control in both directions
- Ideal for cutting long lengths where coiling is necessary
- Very easy to unload

Technical / Order Data

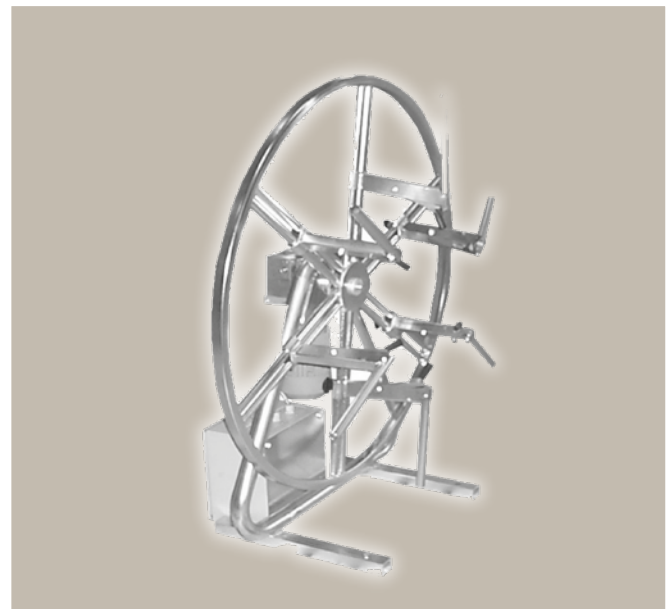

Hose Reel TH 7-15

for service and series production in workshops

Reel dimensions	
Int. Ø min. / max.	adjustable 250 - 800 mm
Max. load of reel	100 kg
Electric power	230 V / 10 A / 50 Hz
Colour	zinc plated
Dimensions	W 600 x H 1400 mm
Weight	75 kg
Part Number	TH7-15

TH 8E-200, -200VDC, -200-ECO, -200-24VDC

Strong Crimping Press

- Crimps
 - all Parker *No-Sliver* hoses up to size -24
 - ParLock and Compact Spiral hoses up to size -16
- Easy installation on the workbench in the workshop area or in the van
- For die sets series 239

Primary Applications

Hose assembly workshops with small series production and services.

Restrictions

Not for ParLock hose fittings in size -20, -24 and -32 (fittings series V4 and V6).



All TH 8E-200 with	Crimp force	130 t
	Crimp range	70 mm
– die set packet PBSET-TH8E-200	Noise level	69 dBA
– quick change tool QDC239.5	Colour	black/silver
Attention: Delivery without oil or connecting plug	Electrical power	400 V / 50 Hz / 3 PH / 3 kW
	Control system	Mikrometer
TH 8E-200	Dimensions	L 800 x B 530 x H 560 mm
	Oil quantity	40 l
	Weight	140 kg
	Part Number	TH8E-200
	Electrical power	400 V / 50 Hz / 3 PH / 3 kW
	Control system	Mikrometer
TH 8E-200-ECO	Dimensions	L 420 x B 535 x H 520 mm
	Oil quantity	40 l
	Weight	88 kg
	Part Number	TH8E-200-ECO
	Electrical power	12 V DC / 24 V DC
	Control system	Mikrometer
TH 8E-200VDC, TH 8E-200-24VDC	Dimensions	L 420 x B 535 x H 520 mm
	Oil quantity	4 l
	Weight	88 kg
	Part Number	TH 8E-200VDC/TH 8E-200-24VDC
Adapter die set, Ø 12–54: PB239-12 PB239-14 PB239-17 PB239-20 PB239-22 PB239-24 PB239-26 PB239-28 PB239-31 PB239-32 PB239-36 PB239-38 PB239-40 PB239-44 PB239-50 PB239-54	Part Number	PBSET-TH8E-200
Quick change tool	Part Number	QDC239.3

TH 8E-530, TH 8E-535-CM

Strong Crimping Press

- Crimps
 - all Parker *No-Sliver* fittings up to size -32 (except Compact Spiral size -32)
- Easy installation on the workbench in the workshop area or in the van
- For die sets series 239L and 266 (adapter die set PB266.239L required)



Primary Applications

Hose assembly workshops with small series production and services.

All TH 8E-530 and TH 8E-535 with
 – adapter die set PB266.239L
 – die set packet (14 mm – 74 mm) PBSET-TH8E-53X
 – quick change tool QDC239.5
 Attention: Delivery without oil or connecting plug

TH 8E-530

TH 8E-530-CM

TH 8E-535-CM

Adapter die set, Ø 12–74: PB239-65-12, PB239-65-14, PB239-65-17, PB239-65-20, PB239-65-22, PB239-65-24, PB239-65-26, PB239-80-28, PB239-80-31, PB239-80-32, PB239-80-36, PB239-80-38, PB239-80-40, PB239-80-44, PB239-100-50, PB266L-54, PB266L-57, PB266L-62, PB266L-67, PB266L-71, PB266L-74

Part Number	PB266.239L
Die rack	Part Number QDS239S
Die set packet , diameter from 14 – 74 mm	Part Number PBSET-TH8E-53X
Quick change tool	Part Number QDC239.5

Restrictions

Not for ParLock hose fittings in size -20, -24 and -32 (fittings series V4 and V6).

Crimp force	200 t
Crimp range	94 mm
Noise level	69 dBA
Colour	black/silver
Electrical power	400 V / 50 Hz / 3 PH / 4 kW
Control system	micrometer
Dimensions	L 700 x W 600 x H 735 mm
Oil quantity	50 l
Weight	248 kg
Part Number	TH8E-530
Electrical power	230-480 V / 50-60 Hz / 3 PH / 4 kW
Control system	C-Touch
Dimensions	L 700 x W 600 x H 735 mm
Oil quantity	50 l
Weight	255 kg
Part Number	TH8E-530-CM
Electrical power	230-480 V / 50-60 Hz / 3 PH / 4 kW
Control system	C-Touch
Dimensions	L 690 x W 600 x H 1053 mm
Oil quantity	55 l
Weight	375 kg
Part Number	TH8E-535-CM

TH8E-800-CM

Strong Crimping Press

- Crimps
 - all Parker *No-Sliver* fittings up to size -32
 - Industrial hose up to 4" (DN 100)
 - SAE 100 R13 / SAE 100 R15 hose
with Parker *No-Sliver* fittings up to size -32
 - SAE 100 R15 hose
with ParLock fittings V4 and V6 ... up to size -20
- Adjustable crimper electronic system C and 3 different crimp programs, manual opening and closing, semi-automatic opening and closing, semi-automatic opening and closing with foot switch or depth stop
- It is possible to crimp small diameters with an adapter die set

Primary Applications

Hose assembly workshops with small series production and services at certified distributors, ParkerStores and hose workshops in the maintenance areas at OEM customers



Restrictions

Not for ParLock hose fittings in size -24 and size-32 (fittings series V4 and V6).

There could be interference with long drop elbow fittings.

Technical / Order Data

Crimping Press TH8E-800-CM with

- adapter die set PB237.239.2L2
- quick change tool QDC239.5
- die set packet (12 mm – 74 mm) PBSET-TH8-800

Attention: Delivery without oil or connecting plug

Electrical power	230-480 V / 50-60 Hz / 3 PH / 4 kW
Crimp force	220 t
Control system	C-Touch
Crimp range	139 mm
Noise level	70 dB (A)
Colour	black/silver
Dimensions	L 690 x W 720 x H 1400 mm
Oil tank capacity	70 l
Weight	without oil 440 kg with oil 510 kg

Part Number TH8E-800-CM

Electrical power	400 V / 50 Hz / 3 PH / 4 kW
Control system	micrometer

Part Number TH8E-800

Part Number	PB237.239.2L2
-------------	---------------

Part Number TA800/A

Part Number	QDS239S
-------------	---------

TH8E-800

Adapter die set

Part Number	PB237.239.2L2
-------------	---------------

Depth stop

Part Number	TA800/A
-------------	---------

Die rack

Part Number	QDS239S
-------------	---------

Die set packet, Ø 12 – 74: PB239-65-12, PB239-65-14, PB239-65-17, PB239-65-20, PB239-65-22, PB239-65-24, PB239-65-26, PB239-80-28, PB239-80-31, PB239-80-32, PB239-80-36, PB239-80-38, PB239-80-40, PB239-80-44, PB239-100-50, PB237L-54, PB237L-57, PB237L-62, PB237L-67, PB237L-71, PB237L-74

Part Number PBSET-TH8E-800

Foot switch

Part Number	FU-HMX
-------------	--------

Mirror set

Part Number	SHS-800
-------------	---------

Quick change tool

Part Number	QDC239.5
-------------	----------

TH 8E-380-CM

Heavy-Duty Crimping Press

- Crimps
 - all Parkrimp and ParLock hose types including 4 and 6 spiral steel wire
 - DIN 4SP/4SH, SAE 100 R13 / R15
 - Multispiral hoses up to size -32
 - all Parker industrial hoses up to 4" (DN 100)

Primary Applications

Heavy-duty crimper for crimping multispiral hoses in workshops for series production. Suitable for all standard Parker hoses.

Technical / Order Data

TH 8E-380-CM with

- Adapter die set package PB237.239.2L2
- Quick change tool QDC239.5
- Die set package PBSET-TH8-380

For V4 and V6 fittings above size -16 long die sets are required (e.g. PB 237L-57)

Attention: Delivery without oil and connecting plug



Restrictions

Special hose assemblies with 2 elbows in extremely long version.

Electrical power	230-480 V / 50/60 Hz / 3 PH / 4 kW
Crimp force	340 t
Control system	Control C + Touch
Crimp range	161 mm
Type of dies	237L / 239L
Open / Close speed	33 / 23 mm/s
Noise level	62 dB (A)
Dimensions	L 1200 x W 600 x H 1700 mm
Weight without oil / with oil	750 kg / 840 kg
Part Number	TH8E-380-CM
Adapter die set package 237/239L	Part Number PB237.239.2L2
Depth Stop Automatic	Part Number TA380/A
Die rack	Part Number QDS239S
Die set package, Ø 12 – 78: PB239-65-12, PB239-65-14, PB239-65-17, PB239-65-20, PB239-65-22, PB239-65-24, PB239-65-26, PB239-80-28, PB239-80-31, PB239-80-32, PB239-80-36, PB239-80-38, PB239-80-40, PB239-80-44, PB239-100-50, PB237L-54, PB237L-57, PB237L-62, PB237L-67, PB237L-71, PB237L-74, PB237L-78	
PBSET-TH8E-380	
Die set package optional Ø 84 – 131: PB237L-84, PB237L-86, PB237L-90, PB237L-96, PB237L-103, PB237L-106, PB237L-111, PB237L-116, PB237L-121, PB237L-126, PB237L-131	
	Part Number PBSET-237L-IH
Foot switch	Part Number FU-HMX
Mirror set	Part Number SHS375-380
Quick change tool	Part Number QDC239.5
Workplace lamp	Part Number TH8-LUS

TH 8E-480-CM

Heavy-Duty Crimping Press

- Crimps
 - all Parkrimp and ParLock hose types including 4 and 6 spiral steel wire
 - DIN 4SP/4SH, SAE 100 R13 / R15 Multispiral hoses up to size -48
 - all Parker industrial hoses up to 8"
- Compact design
- Safe positioning on the fixed 6 o'clock die
- Slide bearings on the crimp tool, no service and 20% less friction



Primary Applications

Heavy Duty Crimping Press for service and series production at workshops

Technical / Order Data

TH 8E-480-CM with

- Adapter die set package PB245.237L
- Adapter die set package PB237.239.2L2
- Quick change tool QDC239.5
- Die set package PBSET-TH8-380

Attention: Delivery without oil and connecting plug

Electrical power	230-480 V / 50-60 Hz / 3 PH / 5.5 kW
Crimp force	450 t
Control system	C-Touch
Crimp range	310 mm
Open speed	20 mm/s
Crimp speed	1.5 mm/s
Close speed	23 mm/s
Noise level	62 dB (A)
Dimensions	L 730 x W 1590 x H 2015 mm
Weight without oil	2600 kg
Oil capacity	300 l
Part Number	TH8E-480-CM
Adapter die set PB245.237L	Part Number PB245.237L
Adapter die set PB237.239.2L2	Part Number PB237.239.2L2
Quick change tool	Part Number QDC239.5
Workplace lamp	Part Number TH8-LUS

TH 2-9

Hose Skiving Machine

- Efficient skiving of hydraulic hoses (external and internal) from size -4 up to -32
- Easily controlled by a footpedal
- Waste collection bin



Primary Applications

For small series and service application.

Restrictions

Not recommended for series production.

Technical / Order Data

Hose Skiving Machine TH 2-9 without skiving tools	Hose capacity, external skiving	4 and 6 layer	size -4 up to -32
	Hose capacity, internal skiving	4 and 6 layer	size -6 up to -32
	Speed	125 rpm	
	Colour	light grey	
	Dimensions	L 600 x W 410 x H 390 mm	
	Weight	35 kg	
Hose Skiving Machine TH 2-9-3PH 3 phases, 400 V	Electrical power	3 PH / 400 V / 50 Hz / 16 A / 0.37 kW	
	Part Number	TH2-9-3PH	
Hose Skiving Machine TH 2-9-1PH 1 phase, 230 V	Electrical power	1 PH / 230 V / 50 Hz / 10 A / 0.37 kW	
	Part Number	TH2-9-1PH	



Internal
skiving tool



External
skiving tool
with one external tool

Skiving tools see page **Ea-29**

TH 2-10-3PH

Hose Skiving Machine

- Efficient skiving of hydraulic hoses (external and internal) from size -4 up to -32
- Semi-automatic electro-pneumatic control-system
- Adjustable pressure and speed
- Automatic self-centering system
- Waste collection bin



Primary Applications

Mainly for hose assembly workshop production for medium and large series.

Restrictions

Work cycle for internal and external skiving takes place separately, not in one step.

Technical / Order Data

Hose Skiving Machine TH 2-10-3PH without skiving tools

Hose capacity, external skiving	
4 and 6 layer	size -4 up to -32
Hose capacity, internal skiving	
4 and 6 layer	size -6 up to -32
Speed	315 rpm
Air pressure	min. 0.7 MPa
Colour	light grey
Electrical power	3 PH / 400 V / 50 Hz / 16 A / 1.2 kW
Dimensions	L 680 x W 1200 x H 1080 mm
Weight	132 kg
Part Number	TH2-10-3PH



Internal
skiving tool



External
skiving tool
with two external tools

Skiving tools see page **Ea-29**

TH 2-13-3PH

Twin-Skive Machine

- Twin-skiving of hydraulic hoses (external and internal) from size -4 up to -32 in one operation
- Semi-automatic electro-pneumatic control-system
- Automatic self-centring system
- Adjustable pressure and speed
- Waste collection bin
- Eliminates work-related injuries



Primary Applications

For hose assembly workshops for series production.

Restrictions

Max. hose outside diameter 75 mm for external skiving.

Technical / Order Data

Hose Skiving Machine TH 2-13-3PH without skiving tools

Hose capacity, external skiving	
4 and 6 layer	size -4 up to -32
Hose capacity, internal skiving	
4 and 6 layer	size -6 up to -32
Speed	400 / 315 rpm
Air pressure	min. 0.7 MPa
Colour	light grey
Electrical power	3 PH / 400 V / 50 Hz / 16 A / 2 x 0.75 kW
Dimensions	L 680 x W 1200 x H 1080 mm
Weight	150 kg
Part Number	TH2-13-3PH

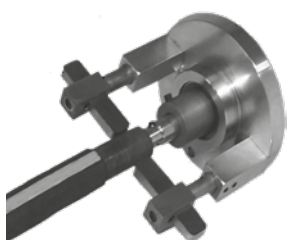

Skiving tool

Skiving tools see page **Ea-29**

Skiving Tools for TH 2-9, TH 2-10-3PH und TH 2-13-3PH

Internal skiving tool for TH 2-9, TH 2-10-3PH and TH 2-13-3PH

Internal skiving tool TH 2-9 and TH 2-10-3PH	Size	Internal skiving tool (without knife)	Internal skiving knife
		Part Number	Part Number
 <p>A: Internal skiving knife</p>	-6	TH2-12-NT-6	TH2-12NK-6
	-8	TH2-12-NT-8	TH2-12NK-8
	-10	TH2-12NT-10	TH2-12NK-1012
	-12	TH2-12NT-12	
	-16	TH2-12NT-16	TH2-12NK-1620
	-20	TH2-12NT-20	
	-24	TH2-12NT-24	TH2-12NK-2432
-32	TH2-12NT-32		

External skiving tool for TH 2-9 and TH 2-10-3PH

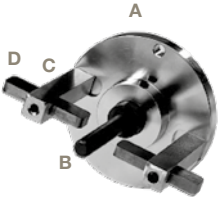
External skiving tool TH 2-9 and TH 2-10-3PH	Size	Mandrel Size Part Number	External skiving tool (without knife)	Additional arm	External skiving knife
			Part Number	Part Number	Part Number
 <p>A: External skiving tool holder B: Mandrel for external skiving C: Holder for skiving tool D: External skiving knife</p>	-4	TH2-11M-4	short arm TH2-11ES	short arm TH2-11ES-1 <small>TH2-10-3PH only</small>	TH2-11EK
	-6	TH2-11M-6			
	-8	TH2-11M-8			
	-10	TH2-11M-10			
	-12	TH2-11M-12	long arm TH2-11EL	long arm TH2-11EL-1 <small>TH2-10-3PH only</small>	
	-16	TH2-11M-16			
	-20	TH2-11M-20			
-24	TH2-11M-24				
-32	TH2-11M-32				

Internal and external skiving tool for TH 2-13-3PH

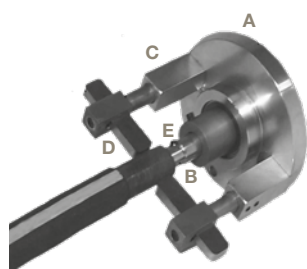

Skiving tool

- A: Tooling holder complete
- B: Mandrel for internal skiving
- C: Holder for external skiving knife
- D: External skiving knife
- E: Internal skiving knife

Internal and external skiving tool TH 2-13-3PH	Size		Mandrel Size Part Number	Internal skiving knife Part Number	External skiving toolholder Part Number	Additional arm	External skiving knife Part Number
						Part Number	
	-6	external	TH2-11M-6		TH2-11ES		TH2-11EK
		internal	TH2-12NT-6	TH2-12NK-6			
	-8		TH2-13M-8	TH2-12NK-8	TH2-13ET	short arm TH2-13ES-1	
	-10		TH2-13M-10	TH2-12NK-1012			
	-12		TH2-13M-12				
	-16		TH2-13M-16	TH2-12NK-1620		long arm TH2-13EL-1	
	-20		TH2-13M-20				
	-24		TH2-13M-24	TH2-12NK-2432			
	-32		TH2-13M-32				

Clean Seal Capsules

The Clean Seal capsule is a simple, easy and clean alternative to cap your hose and fitting assemblies. The Clean Seal cap enables a secure fit due to an easy to use heat shrink system. Reduce your cap complexity as one Clean Seal cap will seal multiple end configurations and sizes, eliminating many unique traditional caps. The Clean Seal process utilizes heat shrink technology to cover the end of a hose assembly. The heat shrink technology eliminates problems due to re-contamination issues. When traditional caps and plugs are forced onto assemblies, plastic debris and particles shred off into your hose, ultimately causing re-contamination.



Packaged		Bulk		Length mm	Hex Sizes Covered	
Part Number	Quantity	Part Number	Quantity		Inch	mm
PCS-2023P	810	PCS-2023B	23400	23	0.47 - 0.71	12 - 18
PCS-2030P	810	PCS-2030B	23400	30	0.47 - 0.71	12 - 18
PCS-2224P	810	PCS-2224B	23500	24	0.63 - 0.83	16 - 21
PCS-2527P	800	PCS-2527B	17600	27	0.71 - 0.91	18 - 23
PCS-2540P	800	PCS-2540B	17600	40	0.71 - 0.91	18 - 23
PCS-2840P	720	PCS-2840B	15200	40	0.87 - 1.02	22 - 26
PCS-3133P	640	PCS-3133B	12240	33	0.94 - 1.14	24 - 29
PCS-3140P	640	PCS-3140B	12240	40	0.94 - 1.14	24 - 29
PCS-3440P	640	PCS-3440B	10240	40	1.07 - 1.26	27 - 32
PCS-3840P	560	PCS-3840B	7800	40	1.09 - 1.42	30 - 36
PCS-4345P	480	PCS-4345B	6240	45	1.26 - 1.61	32 - 41
PCS-4650P	480	PCS-4650B	5760	50	1.34 - 1.73	34 - 44
PCS-5260P	400	PCS-5260B	4400	60	1.62 - 1.97	41 - 50
PCS-5860P	400	PCS-5860B	3600	60	1.93 - 2.20	49 - 56
PCS-6760P	320	PCS-6760B	2560	60	2.16 - 2.56	55 - 65

Example: PCS-AABBX → Example: PCS-4650B

AA = Ø A

BB = length B

X = quantity

B = bulk

P = package

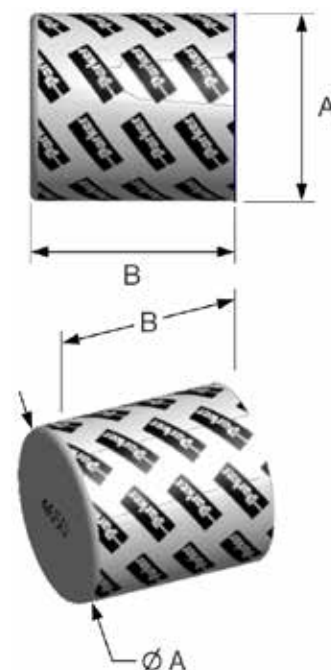

Removal is an easy 3-step process.

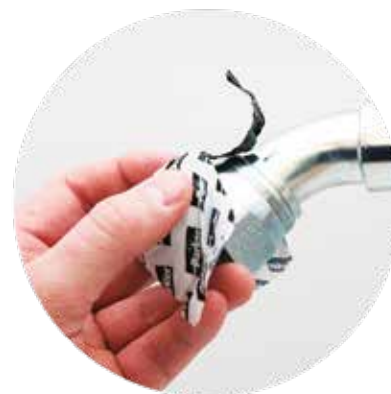

UC-CSS-230VE

Production Heat Shrink machine

- Simple, easy and clean alternative to cap hose and fitting assemblies
- Secure fit due to an easy to use heat shrink system
- Heat shrink technology eliminates problems due to re-contamination issues
- For use on fittings up to -24 (1-1/2")
- Fits straight and elbow fittings
- Easy pull tab removal
- Reduced environmental impact compared to traditional caps: less plastic used, more crushable
- Multiple hoses can be capped at one time



Primary Applications

For hose assembly workshops for series production.



Technical / Order Data

Production Heat Shrink machine
with timer

Fitting	up to size -24
Electrical power	230 V / 50/60 Hz
Dimensions	241 x 520 x 180 mm
Weight	11.8 kg
Part Number	UC-CSS-230VE-G2

Electric heat gun
with case

Fitting	up to size -24
Electrical power	230 V / 50/60 Hz
Dimensions	330 x 330 x 127 mm
Weight	2.7 kg
Part Number	UC-HL-1910E-EU

Flex vacuum pumpstand

Part Number	UC-HG-STAND
--------------------	--------------------

Diffuser, 95 mm, 1-1/2" heat gun connection

Part Number	UC-1.5HD
--------------------	-----------------



Flex vacuum pumpstand



Diffuser

Push-Lok® Assembly Tools 611050G and 611050HV

Tool designed for assembly of Push-Lok® fittings and hoses in all sizes. Toggle actions greatly reduce effort necessary to hold hose and press in fitting. Only a few pounds of force is needed on either handle to quickly assemble any size.

Hose Fitting Insertion Device TH1E-5

for straight and elbow nipples and fittings.

The TH1E-5 is the first manual fitting insertion device for the assembly or pre-assembly of low, medium and high pressure hose assemblies up to size -20. Straight fittings are using an insertion cone or insertion mandrel while bended fittings are inserted into the hose using an insertion disk.

The hose is simply fixed in the clamping unit and the nipple or the fitting is slightly pushed by hand into the hose.

Subsequently the insertion unit which is equipped with insertion cone, mandrel, or disc is pushed to the left by hand lever until the nipple or fitting is completely inserted into the hose.



611050G

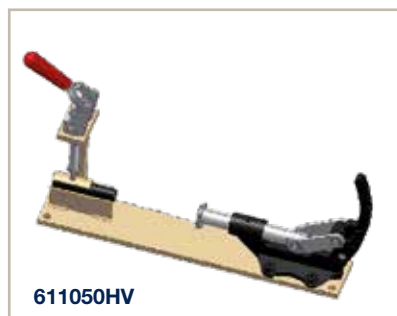

611050HV



TH1E-5

Technical / Order Data

Assembly Tool 611050G	Overall length	320 mm
	Weight	2,2 kg
	Part Number	611050G
Assembly Tool 611050HV "Rigid version"	Dimensions	L 500 x B 90 x H 300 mm
	Weight	7,5 kg
	Part Number	611050HV
Hose Fitting Insertion Device TH1E-5	Dimensions	L 650 x B 250 x H 140 mm
	Weight	25 kg
	Part Number	TH1E-5

Flange Halves

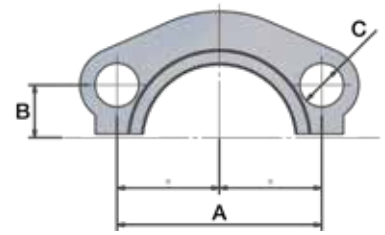

M1H – ISO 6162-1 Flange Half – Standard Series

(for use with 15, 17 and 19 flanges)

Part Number	Flange			A mm	B mm	C mm	max. dynamic working pressure	
	DN	Inch	Size				MPa	psi
M1H-8	13	1/2	-8	38.1	8.8	8.9	34.5	5000
M1H-12	19	3/4	-12	47.6	11.1	10.6	34.5	5000
M1H-16	25	1	-16	52.4	13.1	10.6	34.5	5000
M1H-20	32	1-1/4	-20	58.7	15.1	12.0	28.0	4000
M1H-24	38	1-1/2	-24	69.9	17.9	13.3	21.0	3000
M1H-32	51	2	-32	77.8	21.5	13.5	21.0	3000
M1H-40	64	2-1/2	-40	88.9	25.4	13.5	17.5	2538
M1H-48	76	3	-48	106.4	31.0	16.7	16.0	2321
M1H-56	89	3-1/2	-56	120.7	35.0	16.7	3.5	508
M1H-64	102	4	-64	130.2	38.9	16.7	3.5	508
M1H-80	127	5	-80	152.4	46.1	16.7	3.5	508

50H – ISO 6162-1 Flange Half 5000 psi

(for use with 4A, 4F and 4N flanges)

Part Number	Flange			A mm	B mm	C mm	max. dynamic working pressure	
	DN	Inch	Size				MPa	psi
50H-20	32	1-1/4	-20	58.7	15.1	12.0	34.5	5000
50H-24	38	1-1/2	-24	69.9	17.9	13.5	34.5	5000
50H-32	51	2	-32	77.8	21.5	13.5	34.5	5000

M2H – ISO 6162-2 Flange Half 6000 psi

(for use with 6A, 6F and 6N flanges)

Part Number	Flange			A mm	B mm	C mm	max. dynamic working pressure	
	DN	Inch	Size				MPa	psi
M2H-8	13	1/2	-8	40.5	9.1	9.0	41.0	6000
M2H-12	19	3/4	-12	50.8	11.9	11.0	41.0	6000
M2H-16	25	1	-16	57.2	13.9	13.0	41.0	6000
M2H-20	32	1-1/4	-20	66.7	15.9	15.0	41.0	6000
M2H-24	38	1-1/2	-24	79.4	18.2	17.0	41.0	6000
M2H-32	51	2	-32	96.8	22.2	22.0	41.0	6000

8FH – ISO 6162-2 Flange Half 8000 psi

(for use with 8A, 8F and 8N flanges)

Part Number	Flange			A mm	B mm	C mm	max. dynamic working pressure	
	DN	Inch	Size				MPa	psi
8FH-12-SM	19	3/4	-12	50.8	11.9	11.0	56.0	8000
8FH-16-SM	25	1	-16	57.2	13.9	13.0	56.0	8000
8FH-20-SM	32	1-1/4	-20	66.7	15.9	13.0	56.0	8000
8FH-20-SM-M14	32	1-1/4	-20	66.7	15.9	15.0	56.0	8000



Accessories

Bolts for Flange Halves

Bolts for Flange Halves ISO 6162-1

M1H – ISO 6162-1 Flange Half – Standard Series

(for use with 15, 17 and 19 flanges)



Part Number				 G Thread	A	 max. dynamic working pressure	
	DN	Inch	Size			metric	Inch
ZYLS8X25VZX	13	1/2	-8	M8x1.25	25	34.5	5000
UNC5/16-18X11/4	13	1/2	-8	UNC5/16-18	11/4	34.5	5000
ZYLS10X30VZX	19	3/4	-12	M10x1.5	30	34.5	5000
UNC3/8-16X11/4	19	3/4	-12	UNC3/8-16	11/4	34.5	5000
ZYLS10X30VZX	25	1	-16	M10x1.5	30	34.5	5000
UNC3/8-16X11/4	25	1	-16	UNC3/8-16	11/4	34.5	5000
ZYLS10X30VZX	32	1-1/4	-20	M10x1.5	30	28.0	4000
UNC7/16-14X11/2	32	1-1/4	-20	UNC7/16-14	11/2	28.0	4000
ZYLS12X35VZX	38	1-1/2	-24	M12x1.75	35	21.0	3000
UNC1/2-13X11/2	38	1-1/2	-24	UNC1/2-13	11/2	21.0	3000
ZYLS12X35VZX	51	2	-32	M12x1.75	35	21.0	3000
UNC1/2-13X11/2	51	2	-32	UNC1/2-13	11/2	21.0	3000
ZYLS12X40VZX	64	2-1/2	-40	M12x1.75	40	17.5	2538
UNC1/2-13X13/4	64	2-1/2	-40	UNC1/2-13	13/4	17.5	2538
ZYLS16X50VZX	76	3	-48	M16x2	50	16.0	2321
UNC5/8-11X13/4	76	3	-48	UNC5/8-11	13/4	16.0	2321
ZYLS16X50VZX	89	3-1/2	-56	M16x2	50	3.5	508
UNC5/8-11X2	89	3-1/2	-56	UNC5/8-11	2	3.5	508
ZYLS16X50VZX	102	4	-64	M16x2	50	3.5	508
UNC5/8-11X2	102	4	-64	UNC5/8-11	2	3.5	508
ZYLS16X55VZX	127	5	-80	M16x2	55	3.5	508
UNC5/8-11X21/4	127	5	-80	UNC5/8-11	21/4	3.5	508

- metric bolts according to ISO 4762-10.9 (DIN 912-10.9)

- UNC bolts according to ANSI / ASME B18.3

50H – ISO 6162-1 Flange Half 5000 psi

(for use with 4A, 4F and 4N flanges)

Part Number				 G Thread	A	 max. dynamic working pressure	
	DN	Inch	Size			metric	Inch
-	32	1-1/4	-20	-	-	34.5	5000
UNC7/16-14X11/2	32	1-1/4	-20	UNC7/16-14	11/2	34.5	5000
-	38	1-1/2	-24	-	-	34.5	5000
UNC1/2-13X11/2	38	1-1/2	-24	UNC1/2-13	11/2	34.5	5000
-	51	2	-32	-	-	34.5	5000
UNC1/2-13X11/2	51	2	-32	UNC1/2-13	11/2	34.5	5000

- metric bolts according to ISO 4762-10.9 (DIN 912-10.9)



- UNC bolts according to ANSI / ASME B18.3

Assembly torque see page **Ab-24**

Bolts for Flange Halves ISO 6162-2

M2H – ISO 6162-2 Flange Half 6000 psi

(for use with 6A, 6F and 6N flanges)



Part Number				 G Thread metric Inch	A mm Inch	 max. dynamic working pressure	
	DN	Inch	Size			MPa	psi
ZYLS8X25VZX	13	1/2	-8	M8x1.25	25	42.0	6000
UNC5/16-18X11/4	13	1/2	-8	UNC5/16-18	1-1/4	42.0	6000
ZYLS10X35VZX	19	3/4	-12	M10x1.5	35	42.0	6000
UNC3/8-16X11/2	19	3/4	-12	UNC3/8-16	1-1/2	42.0	6000
ZYLS12X45VZX	25	1	-16	M12x1.75	45	42.0	6000
UNC7/16-14X13/4	25	1	-16	UNC7/16-14	1-3/4	42.0	6000
ZYLS12X45VZX	32	1-1/4	-20	M12x1.75	45	42.0	6000
UNC1/2-13X13/4	32	1-1/4	-20	UNC1/2-13	1-3/4	42.0	6000
ZYLS16X55VZX	38	1-1/2	-24	M16x2	55	42.0	6000
UNC5/8-11X21/4	38	1-1/2	-24	UNC5/8-11	2-1/4	42.0	6000
ZYLS20X65VZX	51	2	-32	M20x2.5	65	42.0	6000
UNC3/4-10X23/4	51	2	-32	UNC3/4-10	2-3/4	42.0	6000
ZYLS24X75VZX	64	2-1/2	-40	M24x3	75	42.0	6000
-	64	2-1/2	-40	-	-	42.0	6000
ZYLS30X90VZX	76	3	-48	M30x3.5	90	42.0	6000
-	76	3	-48	-	-	42.0	6000

- metric bolts according to ISO 4762-10.9 (DIN 912-10.9)

- UNC bolts according to ANSI / ASME B18.3

8FH – ISO 6162-2 Flange Half 8000 psi

(for use with 8A, 8F and 8N flanges)

Part Number				 G Thread metric Inch	A mm Inch	 max. dynamic working pressure	
	DN	Inch	Size			MPa	psi
ZYLS10X45109X	19	3/4	-12	M10x1.5	45	56.0	8000
ZYLS12X50109X	25	1	-16	M12x1.75	50	56.0	8000
ZYLS12X50109X	32	1-1/4	-20	M12x1.75	50	56.0	8000
ZYLS14X50109X	32	1-1/4	-20	M14x2	50	56.0	8000
-	51	2	-32	-	-	34.5	5000

- metric bolts according to ISO 4762-10.9 (DIN 912-10.9)

- UNC bolts according to ANSI / ASME B18.3

Assembly torque see page **Ab-25**

Full Flange System



Provides full flange mounting option for ISO 6162-1 (35.0 MPa/5000 psi) and ISO 6162-2 (42.0 MPa/ 6000 psi) flanges – system flexibility reduces inventory investment.



Once the hose fitting is crimped to the hose, the flange is placed over the fitting end and then is held in place with the retaining ring. When the flange engages the retaining ring, the flange is held securely and is ready to be bolted to the port. Installation to the port is easy – there is no fumbling with the flange halves, and the flange can be rotated for ease of assembly to the port. The full flange system can be used repeatedly because of its patent-pending attachment system – the flange is not permanently locked onto the fitting.



Flange System

ISO 6162-1 (35.0 MPa/ 5000 psi)*

 SAE Flange Size	 max. dynamic working pressure		Flange Part Number	Seal Part Number	Retaining Ring Part Number
	Inch	MPa			
3/4	35.0	5000	R-312-CFX	020119N0552	R12X
1	35.0	5000	R-316-CFX	020122N0552	R16X
1 1/4	35.0	5000	R-320-CFX	020126N0552	R20X
1 1/2	35.0	5000	R-324-CFX	020132N0552	R24X
2	35.0	5000	R-332-CFX	020139N0552	R32X
2 1/2	35.0	5000	R-340-CFX	020231N0552	R40X
3	21.0	3000	R-348-CFX	020235N0552	R48X

Flange System

ISO 6162-2 (42.0 MPa/ 6000 psi)*

 SAE Flange Size	 max. dynamic working pressure		Flange Part Number	Seal Part Number	Retaining Ring Part Number
	Inch	MPa			
3/4	42.0	6000	R-612-CFX	020119N0552	R12X
1	42.0	6000	R-616-CFX	020122N0552	R16X
1 1/4	42.0	6000	R-620-CFX	020126N0552	R20X
1 1/2	42.0	6000	R-624-CFX	020132N0552	R24X
2	42.0	6000	R-632-CFX	020139N0552	R32X
2 1/2	35.0	5000	R-640-CFX	020231N0552	R40X
3	21.0	3000	R-648-CFX	020235N0552	R48X





* 2 1/2 inch max. 35.0 MPa/ 5000 psi
 3 inch max. 21.0 MPa/ 3000 psi

The stainless steel retaining rings and O-rings are recommended for one-time use.

Bolts for Full Flange System ISO 6162

ISO 6162-1 Retaining Ring Flange System

(for use with X5, X7 and X9 flanges)





Part Number				A		
	Flange Part Number	SAE Flange Size Inch	G Thread metric Inch		MPa	psi
ZYLS10X40VZX	R-312-CFX	3/4	M10x1.5	40	35.0	5000
UNC3/8-16X11/4	R-312-CFX	3/4	UNC3/8-16	1-1/4	35.0	5000
ZYLS10X40VZX	R-316-CFX	1	M10x1.5	40	35.0	5000
UNC3/8-16X11/4	R-316-CFX	1	UNC3/8-16	1-1/4	35.0	5000
ZYLS10X40VZX	R-320-CFX	1-1/4	M10x1.5	40	28.0	4000
UNC7/16-14X11/2	R-320-CFX	1-1/4	UNC7/16-14	1-1/2	28.0	4000
ZYLS12X50VZX	R-324-CFX	1-1/2	M12x1.75	50	28.0	4000
UNC1/2-13X11/2	R-324-CFX	1-1/2	UNC1/2-13	1-1/2	28.0	4000
ZYLS12X55VZX	R-332-CFX	2	M12x1.75	55	28.0	4000
UNC1/2-13X11/2	R-332-CFX	2	UNC1/2-13	1-1/2	28.0	4000
ZYLS12X65VZX	R-340-CFX	2-1/2	M12x1.75	65	21.0	3000
UNC1/2-13X13/4	R-340-CFX	2-1/2	UNC1/2-13	1-3/4	21.0	3000
ZYLS16X80VZX	R-348-CFX	3	M16x2	80	21.0	3000
UNC5/8-11X13/4	R-348-CFX	3	UNC5/8-11	1-3/4	21.0	3000

- metric bolts according to ISO 4762-10.9 (DIN 912-10.9)

- UNC bolts according to ANSI / ASME B18.3

ISO 6162-2 Retaining Ring Flange System

(for use with X5, X7 and X9 flanges)

Part Number				A		
	Flange Part Number	SAE Flange Size Inch	G Thread metric Inch		MPa	psi
ZYLS10X45VZX	R-612-CFX	3/4	M10x1.5	45	42.0	6000
UNC3/8-16X11/2	R-612-CFX	3/4	UNC3/8-16	1-1/2	42.0	6000
ZYLS12X45VZX	R-616-CFX	1	M12x1.75	45	42.0	6000
UNC7/16-14X11/2	R-616-CFX	1	UNC7/16-14	1-1/2	42.0	6000
ZYLS14X50VZX	R-620-CFX	1-1/4	M14x2	50	42.0	6000
UNC1/2-13X13/4	R-620-CFX	1-1/4	UNC1/2-13	1-3/4	42.0	6000
ZYLS16X60VZX	R-624-CFX	1-1/2	M16x2	60	42.0	6000
UNC5/8-11X21/4	R-624-CFX	1-1/2	UNC5/8-11	2-1/4	42.0	6000
ZYLS20X70VZX	R-632-CFX	2	M20x2.5	70	42.0	6000
UNC3/4-10X23/4	R-632-CFX	2	UNC3/4-10	2-3/4	42.0	6000
ZYLS24X90VZX	R-640-CFX	2-1/2	M24x3	90	42.0	6000
-	R-640-CFX	2-1/2	-	-	42.0	6000
ZYLS30X100VZX	R-648-CFX	3	M30x3.5	100	42.0	6000
-	R-648-CFX	3	-	-	42.0	6000

- metric bolts according to ISO 4762-10.9 (DIN 912-10.9)

- UNC bolts according to ANSI / ASME B18.3

Assembly torque see page **Ab-24, Ab-25**

Banjo Bolt

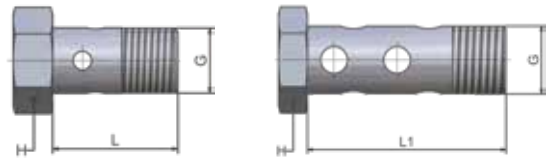

AM/AR – Banjo Bolt (DIN 7643)

Single	Double	I.D. Banjo	G Thread	L Single	L1 Double	H
Part Number	Part Number	mm	metric Inch	mm	mm	mm
AM-03	A2M3	8	M8x1	17	26	12
AM-04	A2M4	10	M10x1	19	30	14
AR-04		10	1/8	19		14
AM-06	A2M6	12	M12x1.5	24	38	17
AM-08	A2M8	14	M14x1.5	26	41	19
AR-08		14	1/4	26		19
AR-08C		14	1/4	26		19
AM-10	A2M10	16	M16x1.5	28	46	22
AR-10		17	3/8	29		22
AM-13		18	M18x1.5	32		24
AM-16		22	M22x1.5	39		27
AR-16		22	1/2	39		27
AM-20		26	M26x1.5	45		32
AR-20		27	3/4	45		32



Complete banjo fitting

853009 – Copper Ring (Form A DIN 7603)

Copper Ring	I.D. Banjo	G Thread
Part Number	mm	metric Inch
853009-8	8	M8x1
853009-10	10	M10x1
853009-10	10	1/8
853009-12	12	M12x1.5
853009-14	14	M14x1.5
853009-14	14	1/4
853009-16	16	M16x1.5
853009-17	17	3/8
853009-18	18	M18x1.5
853009-21	21	1/2
853009-22	22	M22x1.5
853009-26	26	M26x1.5

Banjo fitting, bolt, double bolt, copper ring

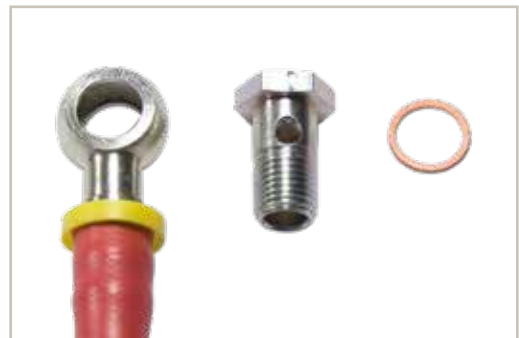

O-Rings

Fittings are supplied with O-rings made from ozone-resistant Nitrile (NBR) rubber compound suitable for temperatures and for ambient temperatures

from -30 °C up to +105 °C
from -40 °C up to +120 °C



On request: Viton® (FPM) compound

from -25 °C up to +200 °C



Ethylene-Propylene (EPDM) compound

from -55 °C up to +150 °C



711509 – O-rings for SAE fittings (05 end configuration)

O-Ring				Size
Part Number	mm	mm	UNF	
711509-1	8.92	1.83	7/16x20	-4
711509-2	10.52	1.83	1/2x20	-5
711509-3	11.89	1.98	9/16x18	-6
711509-4	16.36	2.21	3/4x16	-8
711509-5	19.18	2.45	7/8x14	-10
711509-6	23.47	2.95	1-1/16x12	-12
711509-7	29.74	2.95	1-5/16x12	-16
711509-8	37.47	3.00	1-5/8x12	-20

2-0 – O-rings for ORFS male (JD and JM end configuration)

O-Ring				Size
Part Number	mm	mm	UNF	
2-011N552-90	7.65	1.78	9/16x18	-4
2-012N552-90	9.25	1.78	11/16x16	-6
2-014N552-90	12.42	1.78	13/16x16	-8
2-016N552-90	15.60	1.78	1x14	-10
2-018N552-90	18.77	1.78	1-3/16x12	-12
2-021N552-90	23.52	1.78	1-7/16x12	-16
2-025N552-90	29.87	1.78	1-11/16x12	-20
2-029N552-90	37.82	1.78	2x12	-24



EARG/VURG/VERG – O-rings for BSP fittings

O-Ring				Size
Part Number	mm	mm	BSP	
EARG-4	6.0	1.0	1/4x19	-4
C9RG-10	8.5	1.5	3/8x19	-6
VURG-4	12.0	1.5	1/2x14	-8
EARG-10	13.1	1.6	5/8x14	-10
VERG-14	17.0	1.5	3/4x14	-12
VERG-19	21.0	1.5	1x11	-16
EARG-20	29.5	1.5	1-1/4x11	-20



O-Rings

O-rings for flange ISO 6162-1/-2



for flanges 15, 17, 19, 4A, 4F, 4N, 6A, 6F and 6N

O-Ring				
Part Number	mm	mm	Inch	Size
020210N0552	18.64	3.53	1/2	-8
020214N0552	24.99	3.53	3/4	-12
020219N0552	32.92	3.53	1	-16
020222N0552	37.69	3.53	1 1/4	-20
020225N0552	47.22	3.53	1 1/2	-24
020228N0552	56.74	3.53	2	-32
020232N0552	69.44	3.53	2 1/2	-40
020237N0552	85.32	3.53	3	-48
020241N0552	98.02	3.53	3 1/2	-56
020245N0552	110.72	3.53	4	-64
020253N0552	136.12	3.53	5	-80

CARG – O-rings for metric 24° female swivel hose-end fittings

O-Ring					
Part Number	mm	mm	Light series metric	Heavy series metric	Tube O.D. mm
CARG-6	4.5	1.5	M12x1.5	M14x1.5	6
C9RG-8	6.5	1.5	M14x1.5	M16x1.5	8
C9RG-10	8.5	1.5	M16x1.5	M18x1.5	10
C9RG-12	10.5	1.5	M18x1.5	M20x1.5	12
C9RG-14	12.0	2.0		M22x1.5	14
CARG-15	12.5	2.0	M22x1.5		15
C9RG-16	14.0	2.0		M24x1.5	16
CARG-18	16.0	2.0	M26x1.5		18
C9RG-20	17.0	2.5		M30x2	20
CARG-22	20.0	2.0	M30x2		22
C9RG-25	22.0	2.5		M36x2	25
CARG-28	26.0	2.0	M36x2		28
C9RG-30	27.0	2.5		M42x2	30
CARG-35	32.0	2.5	M45x2		35
C9RG-38	35.0	2.5		M52x2	38
CARG-42	39.0	2.5	M52x2		42

XARG – Flange “D” rings Caterpillar® and 8000 psi style flanges

O-Ring				
Part Number	mm	mm	Inch	Size
XARG-12	25.4	5.0	3/4	-12
XARG-16	31.9	5.0	1	-16
XARG-20	38.2	5.0	1 1/4	-20
XARG-24	44.7	5.0	1 1/2	-24
XARG-32	63.9	5.0	2	-32

Worm Drive Hose Clamps

With cross slotted hex head screw (DIN 3017) for all applications

- Bands and housings of AISI 300 series stainless steel
- Unique interlock construction locks directly into band which tightens under tension
- Shouldered hex head, slotted screw
No spot welds to rupture under stress or corrode
- Rounded band edges
- High efficiency giving high pressure sealing
- Wide clamping range, giving more flexibility to the user



Miniature Worm Drive Hose Clamps

These small, tough, precision-engineered hose clamps provide:

- Low profile
- Narrow housing
- No protrusions
- Highest sealing
- High working pressure at low torque
- Easy to install in confined areas

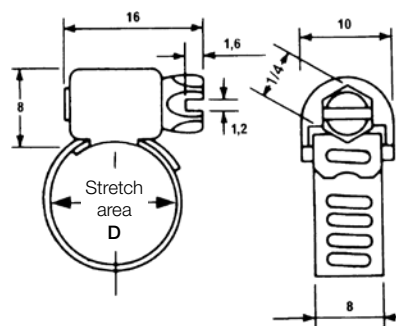

Band width 5/16" - 8 mm

Miniature Standard "M" Series

For all clamping applications meeting normal environmental conditions. Hex head screw made of zinc plated carbon steel.

Miniature Stainless "MS-N" Series

Preferred for those environmental conditions which require the extra protection provided by this 100% stainless steel hose clamp. Hex head screw of AISI 305 series made of stainless steel.

"M" series Part Number	D Stretch area		"MS" series Part Number
	mm	Inch	
M 0200	6 - 16	0.25 - 0.62	MS 0200 N
M 0300	8 - 22	0.30 - 0.87	MS 0300 N
M 0400	16 - 32	0.66 - 1.25	MS 0400 N
M 0500	16 - 38	0.66 - 1.50	MS 0500 N
M 0600	19 - 45	0.66 - 1.75	MS 0600 N
M 0700	25 - 50	1.00 - 2.00	MS 0700 N
M 0800	35 - 60	1.38 - 2.38	MS 0800 N
M 0900	45 - 70	1.75 - 2.75	MS 0900 N
M 1000	58 - 82	2.25 - 3.25	MS 1000 N
M 1100	64 - 90	2.50 - 3.50	MS 1100 N
M 1200	77 - 100	3.00 - 4.00	MS 1200 N

For your safety

Hose clamps are intended to ensure the sealing of flexible hoses carrying fluids under pressure; we therefore recommend that you choose the appropriate hose clamp, adhere to the assembly torques indicated and correctly position the hose clamp onto the fitting. Any deformation of the hose requires tightening of the clamp. We disclaim all responsibility for any product failure that might ensue should these recommendations be ignored.

Worm Drive Hose Clamps

With cross slotted hex head screw (DIN 3017) for all applications

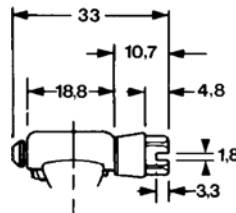
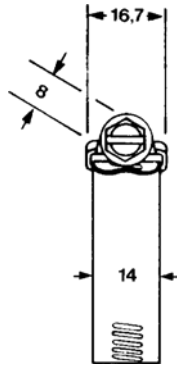
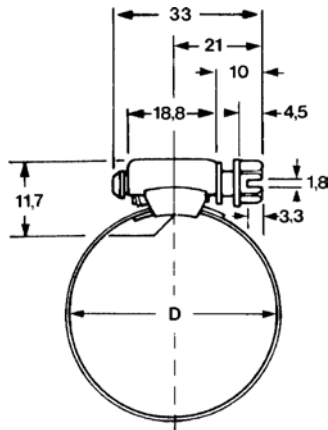

Band width 9/16" - 14 mm

Standard "S" Series

Band and housing of stainless steel for all clamping applications, meeting normal environmental conditions. Hex head screw made of zinc plated carbon steel.

Stainless "SS-N" Series

Preferred for those environmental conditions which require the extra protection provided by this 100% stainless steel hose clamp. Hex head screw of AISI 305 series made of stainless steel.

"S" series Part Number	"SS" series Part Number	D Stretch area		
		size	mm	Inch
S0600	SS0600N	-6	10 - 22	0.38 - 0.87
S0800	SS0800N	-8	11 - 25	0.44 - 1.00
S1000	SS1000N	-10	13 - 27	0.50 - 1.06
S1200	SS1200N	-12	13 - 32	0.50 - 1.25
S1600	SS1600N	-16	19 - 38	0.75 - 1.50
S2000	SS2000N	-20	19 - 44	0.75 - 1.75
S2400	SS2400N	-24	26 - 50	1.00 - 2.00
S2800	SS2800N	-28	34 - 57	1.32 - 2.25
S3200	SS3200N	-32	40 - 64	1.57 - 2.50
S3600	SS3600N	-36	23 - 70	0.88 - 2.75
S4000	SS4000N	-40	29 - 76	1.13 - 3.00
S4400	SS4400N	-44	34 - 82	1.32 - 3.25
S4800	SS4800N	-48	42 - 90	1.63 - 3.50
S5200	SS5200N	-52	48 - 95	1.88 - 3.75
S5600	SS5600N	-56	54 - 100	2.13 - 4.00
S6400	SS6400N	-64	67 - 114	2.63 - 4.50
S7200	SS7200N	-72	76 - 127	3.00 - 5.00
S8000	SS8000N	-80	92 - 140	3.63 - 5.50
S8800	SS8800N	-88	108 - 152	4.25 - 6.00
S9600	SS9600N	-96	120 - 165	4.74 - 6.50
S1040	SS1040N	-104	129 - 178	5.06 - 7.00

Numerous applications in all fields

Automobile industry, ship building, automation systems, agricultural machinery, packaging machines, machine tools, mechanical handling equipment, welding equipment, construction equipment, petrochemical industry, mining, metallurgy.

Protected hose assemblies live longer

In places where the hose assembly is exposed to severe mechanical strain, additional hose protectors such as guards, sleeves etc. have proven to be a good solution. The spring guards or armor guards, for example, prevent kinking of the hose and are the ideal protection against extreme abrasion or possible damage from the outside. Before the fitting is crimped to the hose, the guard needs to be pushed onto the hose – so please remember to order the guards together with your order of hose assembly components.

For some applications it is an advantage to bundle hose assemblies with plastic hose protector coils or sleeves so that they make compact units. For this purpose we recommend using PolyGuard protectors, ParKoil hose protectors and Partek Wraps. Partek Wraps hose sleeves are designed for bundling hose assemblies after installation.

Parker offers a broad range of accessories to work smarter, faster and better!

Spring Guard & Armour Guard (SG & AG)

Parker spring guard and armour guard are two products that prolong the life of your hose lines that are exposed to rugged operating conditions. They distribute bending radii to avoid kinking in hose lines and protect hose from abrasion and deep cuts. Guards are constructed of steel wire and plated to resist rust. See page **Eb-12** and **Eb-13**

PolyGuard & Parkoil (HG & PG)

Protect and bundle your hoses with these spiral guards that minimize kinking and cannot rust. Both the PolyGuard and Parkoil install without removing the hose. See page **Eb-18** and **Eb-19**

Partek (AS & PS)

Nylon woven protective sleeving gives you tough hose abrasion resistance with two versions of coverage – standard “AS” and a lighter “PS” – both providing protection and bundling capability. See page **Eb-14** and **Eb-15**

Minesleeve (DMS)

Best abrasion resistance without adding stiffness to hose assemblies and exceeds the MSHA specifications for flame resistance and flame propagation. See page **Eb-16**

Firesleeve (FS-F)

A flame-resistant sheath that protects your hose from extremely high temperature conditions. See page **Eb-17**

Partek Wrap (PS-BV)

The need for a protective hose sleeve is not always considered while designing for a hose's application. Many hose assembly installations would benefit from a sleeve, but it is not obvious until all the other hoses and components are in place. Partek Wrap enables the hose sleeve to be installed after the hose assemblies have been positioned and secured in place. The Partek Wrap can be used as extra abrasion protection or to wrap multiple hoses or cables together. See page **Eb-20**

Hose Shields (HP-B)

Hose protection shields extend hose life by protecting the hose from abrasion that occurs when hose rubs against other hose, metal or concrete. Parker hose shields are resistant to oil, lubricants, gasoline, most solvents and can withstand ambient temperatures from -40 °C to +150 °C. Easily installed and secured by cable ties without disconnecting any hose lines. See page **Eb-21**



SG – Spring Guard

Spring Guards protect the hose cover against abrasion and are constructed of steel wire and plated to resist rust.



Hose I.D. Part Number	SG-060	SG-066	SG-072	SG-084	SG-097	SG-106	SG-113	SG-122	SG-131	SG-155	SG-166	SG-182	SG-209	SG-220	SG-232	SG-270
Hose I.D. mm	15,20	16,75	18,25	21,30	24,60	26,90	28,70	30,95	33,25	39,35	42,15	46,20	53,05	55,85	58,90	68,55
201, 206, 221FR, 244	-4	-5	-6	-8	-10		-12		-16	-20		-24			-32	
213, 285, 293	-4/-5	-6		-8	-10	-12			-16	-20		-24		-32		
301SN, 304		-4	-5	-6	-8	-10		-12		-16			-20		-24	
421RH, 421SN, 421TC, 426, 436, 441, 441RH, 461LT, 462, 462TC, 462ST, 462PU, 463, 471TC, 493, 611HT, 681, 681DB, BCH2, HT2	-4	-5	-6	-8	-10		-12			-16		-20	-24			-32
492, 492TC, 492ST, BCH1, 692, 692PU, 692TC	-4/-5	-6		-8	-10		-12			-16	-20					
372, 372RH, 372TC, 371LT, 701, 701TC					-6	-8		-10	-12		-16		-20		-24	
774, F42						-8			-12	-16			-20	-24		-32
731, 731TC									-12		-16		-20		-24	
801PLUS, 801RH, 804, 821FR, 830M, 836, 837BM, 837PU, 838M, 846	-4/-5	-6		-8	-10		-12		-16							
811, 881, H29, H29ST, H29TC									-12	-16		-20		-24		-32
H31, H31ST, H31TC			-4		-6	-8		-10	-12		-16					
R35, R35TC									-12		-16	-20			-24	
R42, R42ST, R42TC								-10	-12		-16		-20		-24	
R50TC, R56TC			-4		-6	-8		-10	-12	-16			-20			
787, 787TC, 787ST, 797, 797TC, 797ST, 797RH	-4		-6		-8	-10		-12		-16		-20		-24		-32
722, 722TC, 722ST				-6	-8		-10		-12	-16						
412, 412ST	-4/-5 -6															
477, 477RH, 477TC, 477ST, 387, 387TC, 387ST, 487, 487TC, 487ST	-4	-5	-6	-8	-10		-12			-16			-20	-24		-32
SX35, SX35LT, SX35TC, SX42, SX42LT, SX42TC									-12	-16			-20			
BPK					-6	-8				-12		-16				
FA35					-6	-8		-10	-12		-16		-20			-24

AG – Armour Guard

For extreme abrasion or possible damage from the outside, the corrosion-protected steel flat coil sleeve is recommended.



Hose	I.D. mm Part Number	AG-060	AG-066	AG-072	AG-084	AG-097	AG-106	AG-113	AG-122	AG-131	AG-155	AG-161	AG-166	AG-182	AG-209	AG-232	AG-270	AG-292	AG-319
		15.20	16.75	18.25	21.30	24.60	26.90	28.70	30.95	33.25	39.35	40.85	42.15	46.20	53.05	58.90	68.55	74.20	81.00
201, 206, 221FR		-4	-5	-6	-8	-10		-12		-16	-20			-24		-32		-40	
213, 285, 293		-4/-5	-6		-8	-10	-12			-16	-20			-24				-40	
301SN, 304			-4	-5	-6	-8	-10		-12		-16				-20	-24		-32	
421RH, 421SN, 426, 436, 441, 441RH, 461LT, 462, 462TC, 463, 471TC, 492, 493, 611HT, 681, 681DB, 692		-4	-5	-6	-8	-10		-12			-16			-20	-24		-32		-40
372, 372RH, 371LT, 701						-6	-8		-10	-12	-16				-20	-24			
774				-6	-8			-10		-12	-16				-20		-32		
731										-12			-16		-20	-24		-32	
801PLUS, 801RH, 804, 821FR, 836, 837BM		-4/-5		-6	-8	-10		-12		-16									
811, 881, H29, H29ST, H29TC										-12	-16			-20			-32		-40
H31, H31ST, H31TC				-4		-6	-8		-10	-12		-16							
R35, R35TC										-12		-16		-20		-24		-32	
R42, R42ST, R42TC									-10	-12		-16			-20	-24		-32	
R50TC / R56TC						-6	-8		-10	-12		-16			-20				
787TC, 797TC				-6	-8		-10		-12		-16			-20		-24	-32		
412		-4/-6																	
477		-4	-5	-6	-8		-10			-12	-16								

AS – Partek® Nylon Protective Sleeve

Parker’s Partek Nylon Protective Sleevings gives you tough hose abrasion protection two ways. First, per the ISO 6945 specification, Partek has a unique tubular weave nylon construction, Partek “AS” is strong enough to withstand greater than 200,000 abrasion cycles without wearing through the fabric at any location.

In addition, this weave also gives an exceptionally smooth interior wall, allowing rubber hose to move freely inside the sleeve. This provides easy installation and prevents any internal abrasion problems. Partek sleeving is available in either black or yellow and in sizes to fit most hydraulic hose. Partek, the quick and easy solution to hose protection in high-abrasion areas.



Temperature Range -55 °C up to +120 °C

Part Number		I.D. round		I.D. flat	
		mm	Inch	mm	Inch
black	yellow				
AS-B-11	AS-Y-11	19	0.75	27	1.07
AS-B-13	AS-Y-13	24	0.93	34	1.34
AS-B-15	AS-Y-15	29	1.13	42	1.66
AS-B-17	AS-Y-17	31	1.22	46	1.82
AS-B-19	AS-Y-19	34	1.35	51	2.02
AS-B-22	AS-Y-22	36	1.43	54	2.13
AS-B-27	AS-Y-27	41	1.63	62	2.45
AS-B-33	AS-Y-33	46	1.81	70	2.75
AS-B-35	AS-Y-35	56	2.19	85	3.33
AS-B-37	AS-Y-37	60	2.38	92	3.63
AS-B-39	AS-Y-39	67	2.63	102	4.02
AS-B-45	AS-Y-45	73	2.88	113	4.43
AS-B-47	AS-Y-47	80	3.13	122	4.80
AS-B-53	AS-Y-53	86	3.38	132	5.20
AS-B-58	AS-Y-58	92	3.63	142	5.59
AS-B-64	AS-Y-64	102	4.00	157	6.18

PS – Partek® Nylon Protective Sleeve

Parker's Partek Nylon Protective Sleevings gives you tough hose abrasion protection two ways. First, per the ISO 6945 specification, Partek has a unique tubular weave nylon construction, Partek "PS" is strong enough to withstand greater than 50,000 abrasion cycles without wearing through the fabric at any location. In addition, this weave also gives an exceptionally smooth interior wall, allowing rubber hose to move freely inside the sleeve. This provides easy installation and prevents any internal abrasion problems. Partek sleeving is available in either black or yellow and in sizes to fit most hydraulic hose. Partek, the quick and easy solution to hose protection in high-abrasion areas.



Temperature Range -55 °C up to +120 °C

Part Number	I.D. round		I.D. flat	
	mm	Inch	mm	Inch
PS-B-12	19	0.75	27	1.08
PS-B-13	23	0.91	34	1.32
PS-B-15	27	1.06	40	1.56
PS-B-17	31	1.22	46	1.82
PS-B-22	36	1.42	54	2.14
PS-B-33	46	1.81	70	2.75
PS-B-35	56	2.19	85	3.33
PS-B-37	60	2.38	92	3.63
PS-B-39	67	2.63	102	4.02
PS-B-45	73	2.88	113	4.43
PS-B-47	80	3.13	122	4.8
PS-B-80	127	5.00	197	7.75
PS-B-88	140	5.50	217	8.54

DMS – Minesleeve

Parker Minesleeve offers the best abrasion resistance without adding stiffness to hose assemblies and exceeds the MSHA specifications for flame resistance and flame propagation. Burst tests performed according to SAE J343 on hose assemblies covered with Minesleeve (DMS) show an oil spill retention capability of 7 times greater than similar products. Also suitable for bundling small hose assemblies, tubing or wires.



- Abrasion resistance
 - offers the best abrasion resistance without adding stiffness to hose assemblies
- Fire & flame resistance
 - exceeds US MSHA specifications for flame resistance & flame propagation
- Electrical conductivity
 - tests performed to ISO 8031 on hose assemblies covered with minesleeve show electrical conductivity values well below the specification requirements
- Oil spill retention
 - burst tests performed according to SAE J343 on hose assemblies covered with minesleeve show an oil spill retention capability of 7 times greater than similar products, also suitable for bundling small hose assemblies, tubing or wires
- Approvals: MSHA & UK COAL

Temperature Range -50 °C up to +120 °C

Part Number	I.D. round		I.D. flat	
	mm	Inch	mm	Inch
DMS-23	23	0.91	39	1.54
DMS-27	27	1.06	45	1.77
DMS-31	31	1.22	52	2.05
DMS-36	36	1.42	57	2.24
DMS-47	47	1.85	77	3.03
DMS-55	55	2.17	89	3.5
DMS-66	66	2.60	107	4.21
DMS-85	85	3.35	136	5.35
DMS-93	93	3.66	149	5.87
DMS-127	127	5.00	197	7.75

FS-F – Fire Sleeves

Parker Firesleeve is a flame resistant sheath that protects the hose from extreme temperature conditions. Firesleeve easily slides over hoses and readily expands over fitting. When fitting the fire sleeve to hose assemblies with reusable or crimped fittings, a fire sleeve clamp must be used.



- Braided fiberglass sleeve with orange, bonded and seamless silicone rubber cover
- Certification:
 - UL 1441 Certified
 - VW1 Flame Test Certified
 - MSHA Certified for use in underground mines
 - SAE AS1072E
 - GL-Germanischer Lloyd Certified for 800 °C for 30 min.
 - BS EN 373 Molten Splash Tested
 - BS EN 388 Abrasion Tested
- Conforms to SAE Aerospace Standard 1072A Type 2A
- Temperature Range -54 °C up to +260 °C
- BS EN ISO 6940 Flame Resistance Tested
- BS EN ISO 6530 Oil Resistance Tested
- BS 2576 Tensile Strength Tested
- MIL-C-24576A
- PJA and P96 Thermal Conductivity

Part Number	min. I.D.		max. O.D.		Suction Hose (R4)			1-/2-Wire Braided			Multispiral		
	mm	Inch	mm	Inch	inch	mm	size	inch	mm	size	inch	mm	size
FS-F-10	15	0.58	25	0.97				1/4	6	-4			
FS-F-11	17	0.65	26	1.03				1/4	6	-4			
FS-F-12	18	0.71	28	1.09				5/16	8	-5			
FS-F-14	21	0.84	31	1.22				3/8	10	-6			
FS-F-16	24	0.96	35	1.38				1/2	13	-8	1/4	6	-4
FS-F-18	27	1.08	38	1.50				1/2	13	-8	3/8	10	-6
FS-F-20	31	1.21	40	1.59				5/8	16	-10	1/2	13	-8
FS-F-22	34	1.34	44	1.75	3/4	19	-12	3/4	19	-12	5/8	16	-10
FS-F-24	37	1.46	48	1.90				1	25	-16	3/4	19	-12
FS-F-28	43	1.71	52	2.06	1	25	-16	1	25	-16	1	25	-16
FS-F-30	47	1.84	56	2.19									
FS-F-32	50	1.96	59	2.32	1 1/4	32	-20	1 1/4	32	-20			
FS-F-38	59	2.34	70	2.74			-24	1 1/4	32	-20	1 1/4	32	-20
FS-F-40	63	2.46	71	2.79				1 1/2	38	-24	1 1/2	38	-24
FS-F-48	75	2.96	86	3.40	2	51	-32	2	51	-32	2	51	-32
FS-F-60	94	3.71	105	4.15	2 1/2	65	-40	2 1/2	65	-40	2 1/2	65	-40
FS-F-64	102	4.10	114	4.50	3	76	-48	3	76	-48	3	76	48
FS-F-72	114	4.60	126	5.00	3.5	90	56						
FS-F-80	127	5.00	139	5.50	4	102	64						

HG – PolyGuard Hose Protector

Heavy duty polyethylene provides protection in rugged operating conditions, great for bundling high-pressure hose lines



- Shields hose from abrasion and cuts
- Easy to install without removing hose lines: no clamps needed
- Minimises risk of kinking
- Resistant to air, water, oil, gasoline, hydraulic fluid and most solvents
- Ideal for bundling plastic tubing or hose lines
- Cannot rust or corrode
- Color: black

Caution: This material will support combustion

Temperature Range -40 °C up to +93 °C

Part Number	min. I.D.		1-/2-wire braided			Multispiral			Suction hose (R4)		
	mm	Inch	Inch	mm	Size	Inch	mm	Size	Inch	mm	Size
HG-075	18.3 - 19.8	0.72 - 0.78	1/2 5/8	13 16	-8 -10	1/4 3/8	6 10	-4 -6	-	-	-
HG-100	24.6 - 26.2	0.97 - 1.03	3/4	19	-12	1/2 5/8	13 16	-8 -10	3/4	19	-12
HG-125	31.0 - 32.5	1.22 - 1.28	1	25	-16	3/4	19	-12	-	-	-
HG-150	37.30 - 38.9	1.47 - 1.53	1 1/4	32	-20	1	25	-16	1 1 1/4	25 32	-16 -20
HG-200	50.0 - 51.6	1.97 - 2.03	1 1/2 2 2 1/2	32 38 51	-24 -32 -40	1 1/4 1 1/2 2	32 38 51	-20 -24 -32	1 1/2 2 2 1/2	32 38 51	-24 -32 -40
HG-350	88.1 - 89.7	3.47 - 3.53	3	76	-48	2 1/2 3	65 76	-40 -48	3	76	-48

PG – ParKoil Hose Protector

Lower-cost protection for applications that call for a tighter bend radius and are less demanding



- Shields hose from abrasion and cuts
- Easy to install without removing hose lines: no clamps needed
- Minimises risk of kinking
- Resistant to air, water, oil, gasoline, hydraulic fluid and most solvents
- Ideal for bundling plastic tubing or hose lines
- Cannot rust or corrode
- Color: black

Caution: This material will support combustion

Temperature Range -17 °C up to +93 °C

Part Number	min. I.D.		1-/2-wire braided			Multispiral			Suction hose (R4)		
	mm (± 1.25)	Inch (± 0.05)	Inch	mm	Size	Inch	mm	Size	Inch	mm	Size
PG-038	9.65	0.38	3/16	5	-3	-	-	-	-	-	-
PG-050	12.70	0.50	1/4 5/16	6 8	-4 -5	-	-	-	-	-	-
PG-062	15.75	0.62	3/8	10	-6	1/4	6	-4	-	-	-
PG-075	19.05	0.75	1/2	13	-8	3/8	10	-6			
PG-088	22.35	0.88	5/8	16	-10	1/2	13	-8			
PG-100	25.40	1.00	3/4	19	-12	5/8	16	-10			
PG-119	30.25	1.19	-	-	-	3/4	19	-12	3/4	19	-12
PG-138	35.05	1.38	1 1 1/4	25 32	-16 -20	1 1 1/4	25 32	-16 -20	1	25	-16
PG-188	47.75	1.88	1 1/2 2	38 51	-24 -32	1 1/2 2	38 51	-24 -32	1 1/2 2	38 51	-24 -32

PS – Partek Wrap

Nylon hose sleeve designed for bundling hose assemblies after installation

- Post-assembly installation
- Light weight and high flexibility
- Urethane-coated 1050 ballistic Nylon
- Ambient temperature range of -51 °C to 93 °C
- Fast and easy installation
- Designed for added abrasion resistance or bundling of multiple hoses
- Can be cut to size with household scissors



Part Number	I.D. round		I.D. flat	
	mm	Inch	mm	Inch
PS-BV-200	50	2	80	3.2
PS-BV-300	75	3	80	3.2
PS-BV-400	100	4	162	6.5
PS-BV-500	125	5	203	8.1
PS-BV-600	150	6	243	9.7
PS-BV-700	175	7	283	11.3
PS-BV-800	200	8	325	13.0

WKS Rubber hand grip

For *No-Skive* high pressure water cleaning hoses



Hand Grip		Hose I.D.				L mm	D1 mm	D2 mm
Part Number	Colour	DN	Inch	Size	mm			
WKS-4-BLK	black	6	1/4	-4	6.4	120	15.0	24
WKS-4-BLU	blue	6	1/4	-4	6.4	120	15.0	24
WKS-5-BLK	black	8	5/16	-5	7.9	150	17.0	34
WKS-5-BLU	blue	8	5/16	-5	7.9	150	17.0	34
WKS-6-BLK	black	10	3/8	-6	9.5	150	19.5	34
WKS-6-BLU	blue	10	3/8	-6	9.5	150	19.5	34
WKS-8-BLK	black	12	1/2	-8	12.7	150	22.5	34
WKS-8-BLU	blue	12	1/2	-8	12.7	150	22.5	34
WKS-8-GRA	grey	12	1/2	-8	12.7	150	22.5	34

HP-B – Hose Shield

Hose protection shields extend hose life by protecting the hose from abrasion that occurs when hose rubs against other hose, metal or concrete. Parker hose shields are resistant to oil, lubricants, gasoline, most solvents and can withstand ambient temperatures from -40 °C to +150 °C. Easily installed and secured by cable ties without disconnecting any hose lines.

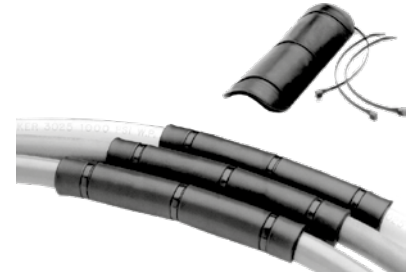

- Use with hose from size -4 up to size -32
- Eliminate hose abrasion on concrete, metal or any rough surface
- Guard against hose deterioration on mobile hydraulic equipment
- Let Parker fill all your hydraulic and pneumatic hose product needs

Hose Shields KIT HP-B-13X18-KIT with – 2 x HP-13 RFL Hose Protectors, length 101 mm (4") – 2 x HP-15 RFL Hose Protectors, length 152 mm (6") – 4 x HP-18 RFL Hose Protectors, length 203 mm (8") – 30 x HT-12 Tie Wraps – 30 x HT-16 Tie Wraps – 15 x HT-22 Tie Wraps	Part Number	HP-B-13X18-KIT
Counter Display HP-B-13-RFL with – 10 x HP-B-13 Hose Protectors, length 101 mm (4") – 30 x HT-12 Tie Wraps	Part Number	HP-B-13-RFL
Counter Display HP-B-15-RFL with – 10 x HP-B-15 Hose Protectors, length 152 mm (6") – 30 x HT-16 Tie Wraps	Part Number	HP-B-15-RFL
Counter Display HP-B-18-RFL with – 5 x HP-B-18 Hose Protectors, length 203 mm (8") – 15 x HT-18 Tie Wraps	Part Number	HP-B-18-RFL
Hose Protector , length 101 mm (4")	Part Number	HP-B-13
Hose Protector , length 152 mm (6")	Part Number	HP-B-15
Hose Protector , length 203 mm (8")	Part Number	HP-B-18

Hose Whip Restraint

Safety Restraining System for Pressure Hoses

- Prevents whipping of a pressurized hose in the vent of the hose separating from its fitting
- The system consists of two parts
 - a hose collar and a cable assembly



Part Number	A		B	
	Inch	mm	Inch	mm
WRC1212	0.47	12	0.492	12.5
WRC1313	0.51	13	0.531	13.5
WRC1415	0.55	14	0.591	15
WRC1718	0.67	17	0.709	18
WRC1819	0.71	18	0.748	19
WRC2021	0.79	20	0.827	21
WRC2223	0.87	22	0.906	23
WRC2425	0.95	24	0.984	25
WRC2526	0.98	25	1.024	26
WRC2728	1.06	27	1.102	28
WRC2829	1.10	28	1.142	29
WRC3031	1.18	30	1.220	31
WRC3435	1.34	34	1.378	35
WRC3637	1.42	36	1.457	37
WRC3839	1.50	38	1.535	39
WRC4445	1.73	44	1.772	45
WRC4547	1.77	45	1.850	47
WRC4850	1.89	48	1.969	50
WRC5153	2.01	51	2.087	53
WRC5456	2.13	54	2.205	56
WRC5759	2.25	57	2.330	59
WRC6365	2.48	63	2.559	65
WRC6971	2.72	69	2.795	71
WRC7577	3.00	75	3.030	77
WRC8486	3.30	84	3.380	86
WRC8789	3.42	87	3.500	89

Hose collars

for Hose Whip Restraint System

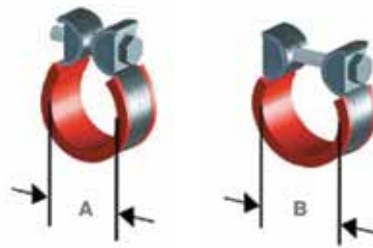

Cable Assemblies

for hoses attached with port adapters



Cable Assemblies

for hoses using flange-style connections
 ISO 6162-1 (35.0 MPa/5000 psi) and
 ISO 6162-2 (42.0 MPa/ 6000 psi)

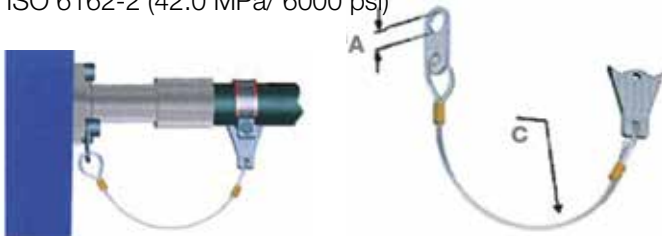

Part Number	A		C	
	Inch	mm	Inch	mm
WRF085	0.33	8.5	11.81	300
WRF105	0.41	10.5	17.72	450
WRF125	0.49	12.5	17.72	450
WRF145	0.57	14.5	17.72	450
WRF165	0.65	16.5	17.72	450
WRF205	0.81	20.5	17.72	450

Part Number	A		C	
	Inch	mm	Inch	mm
WRA145	0.57	14.5	11.81	300
WRA170	0.67	17.0	11.81	300
WRA185	0.73	18.5	11.81	300
WRA205	0.81	20.5	11.81	300
WRA225	0.89	22.5	11.81	300
WRA245	0.96	24.5	11.81	300
WRA265	1.04	26.5	11.81	300
WRA305	1.20	30.5	11.81	300
WRA340	1.34	34.0	17.72	450
WRA365	1.44	36.5	17.72	450
WRA425	1.67	42.5	17.72	450
WRA455	1.79	45.5	17.72	450
WRA490	1.93	49.0	17.72	450
WRA525	2.07	52.5	17.72	450
WRA600	2.36	60.0	17.72	450

HS – Containment Grips

- Material: electrogalvanized steel wire

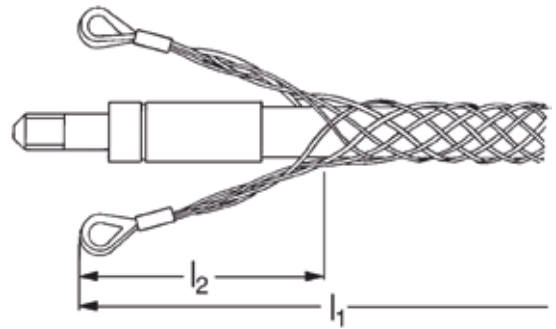

Part Number	Hose I.D.				Ø mm	Working load kN	Breaking load kN	Total length l1 mm	Length of loops l2 mm
	DN	Inch	Size	mm					
HS-03	5	3/16	-3	4.8	9 - 15	3	9	600	200
HS-05	8	5/16	-5	7.9	12 - 20	6	18	600	200
HS-08	12	1/2	-8	12.7	20 - 30	11	33	600	200
HS-12	20	3/4	-12	19.0	30 - 40	11	33	600	200
HS-16	25	1	-16	25.4	40 - 50	16	48	600	200

Thread Identification Kit

The thread identification tools are useful to help you identify international threads such as:

- European threads (Metric, BSPP, BSPT threads) and
- U.S. threads (NPT and SAE straight threads UNF)



Technical / Order Data

Thread identification kit
with thread gauges, a set of callipers,
thread profiles and instruction booklet

Part Number	English	H905375-GB
Part Number	German	H905375-DE
Part Number	French	H905375-FR

The components of the thread ID Kit are not high-precision gauges but simple instruments for workshop use.

Parker „Hoze-Oil“

Parker's hose assembly lubricant is pressure and temperature resistant. The lubrication effect will help to insert Parker No-Skive hose and fittings. If necessary simply wet the fitting end with a drop of hoze oil.

Volume 1 l
Part Number Hoze-Oil



OilOn TH 11-3

Oiling pad for lubrication of fittings

The perfect way to lubricate the fitting, making it easier to insert into the hose. A foam rubber sponge that evenly disperses the oil onto the fitting, in an effective and easy manner.

Material steel/plastic
 Dimensions L 130 x W 130 x H 70 mm
Part Number TH11-3

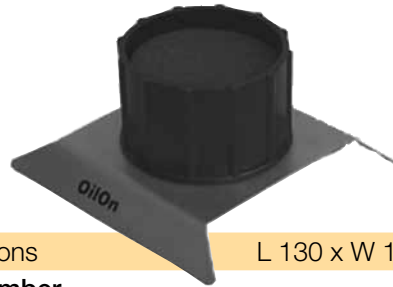

Push-Lok® Assembly Oil H896137

Water-oil emulsion for easier assembly of Parker Push-Lok® fittings. This product is very useful in combination with 830M, 837BM and 837PU hoses as the Push-Lok® assembly oil is free from wetting disturbing substances, e.g. silicone (Labs-free).

Volume 1 l
Part Number H896137



KarryKrimp® 1 / KarryKrimp® 2

KarryKrimp 1 crimps Parkrimp® fittings 16, 26, 43, 46, 48 series size -4 up to -20

KarryKrimp 2 crimps Parkrimp® fittings 16, 26, 43, 46, 48, 70, 73 and 77 series

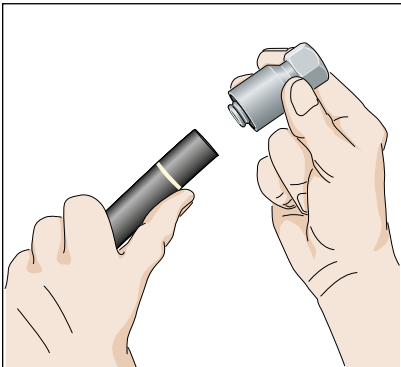

1. Mark the hose insertion depth acc. crimpable with a marker and push hose into fitting until the mark on the hose is even with the end of the shell. If necessary simply wet the fitting end with a drop of hoze oil. Do not lubricate if using spiral hose.

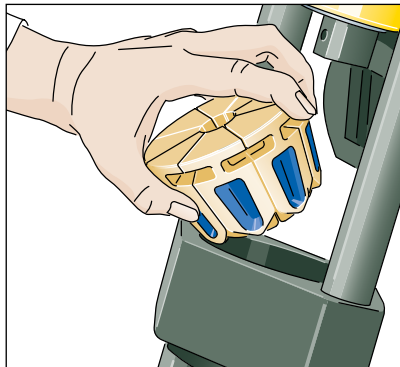

2. Pull pin and drop hinged die-train in place. Pay attention to die segment location.

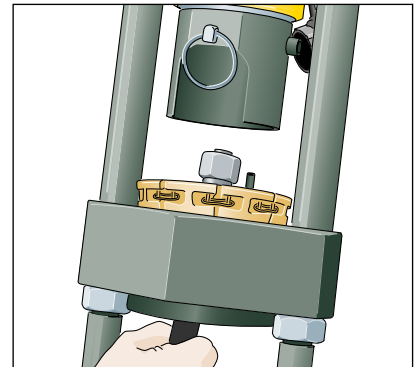

3. Insert fitting into the dies. Release, fitting will self position.



3. (a) Position the fitting on the die step.

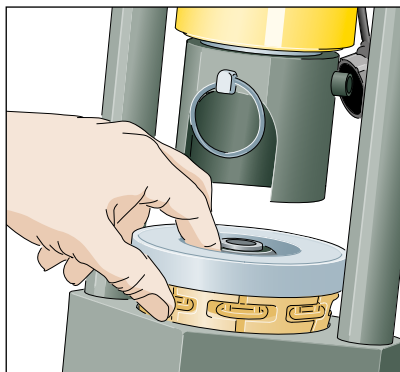

4. Place die ring on top of the dies.

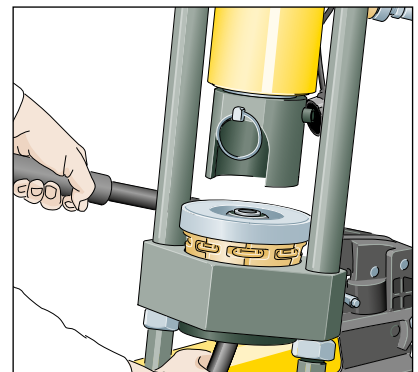

5. Position cylinder and replace pin. Pump until die ring contacts base plate.

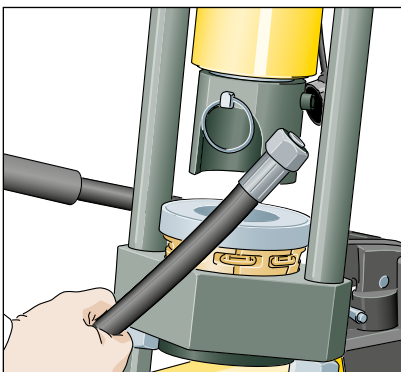

6. Release pressure
– remove finished assembly.

Parkrimp® 2

Parkrimp® fittings 16, 26, 43, 46, 48, 70, 73 and 77 series

For one-piece die sets 80C- ... and 83C- ... size -4 to -16



With the pusher in the full up position, lift the back half of the split die ring. Lock it in the up position by pushing the slide pin in (the slide pin is located inside the pusher at the back).

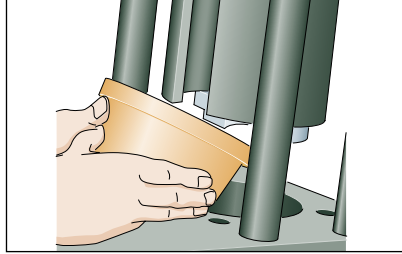

Carefully insert the adapter bowl into the base bowl. The adapter bowl must be tilted toward the back of the crimper during insertion.

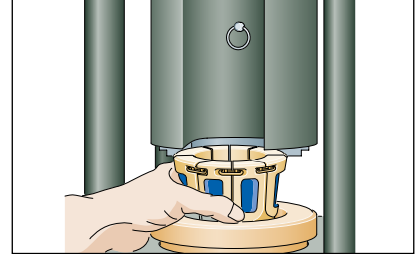

Insert the proper size and series die set into the adapter bowl.
Note: die sets are colour coded by size and have the fitting series and dash size stamped on the top.
Pay attention to die segment location.

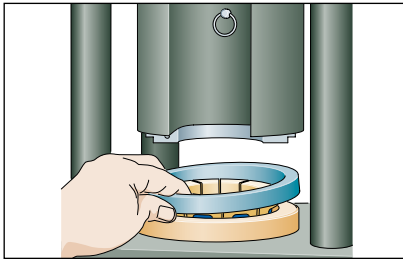

When swaging 43 series fittings on 100R2, 100R3, 100R4 and 100R9 type hose, the black spacer ring must be placed.

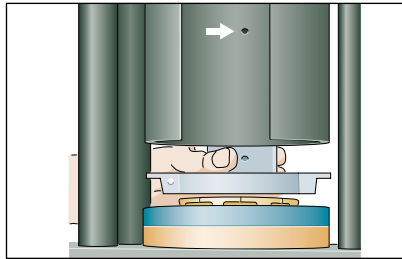

Lower the back half of the split die ring onto the dies by pulling the slide pin forward.

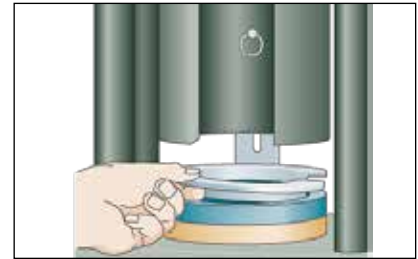

Insert the front half of the split die ring aligning the pin in the half with the hole in the front half.

For two-piece die sets 83C-... size -20 to -32

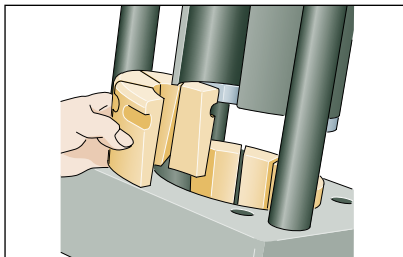

Insert the proper size die set into the die bowl (the die sets are in two halves of four dies each; Place one half in the back and one half in the front to facilitate removal of bent tube fittings).

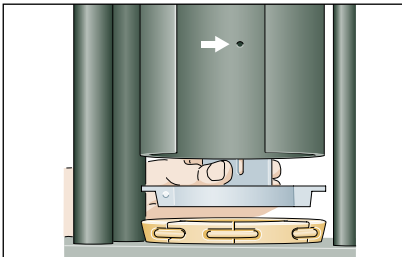

Lower the back half of the split die ring onto the dies by pulling the slide pin forward.

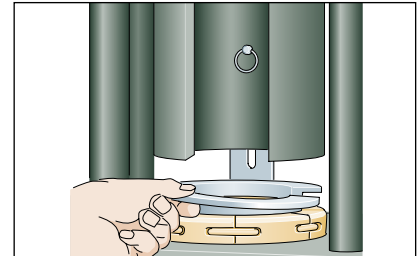

Insert the front half of the split die ring aligning the pin in the half with the hole in the front half.



Parkalign® feature
Position hose from below in dies.
Rest bottom of coupling on die step.

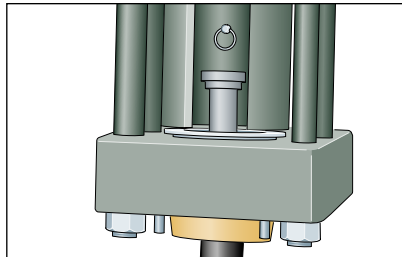

Turn on the pump by pressing the button on the left hand switch box. Lower the pusher by pressing the lower button on the right hand switch box. When the die ring contacts the base plate, the swaging is complete.

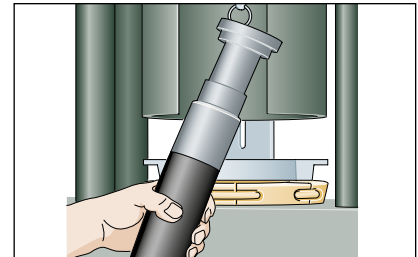

Push the black button at the top of the switch box to open dies and remove the finished assembly.
You do not have to remove any tooling to remove or insert straight fittings. The front half of the split die ring and the front die train must be removed to insert and remove bent tube fittings.

Your crimp source online keeps you always up-to-date

Crimpsource online is your tool for a fast, easy and exact assembly of hose products in Europe

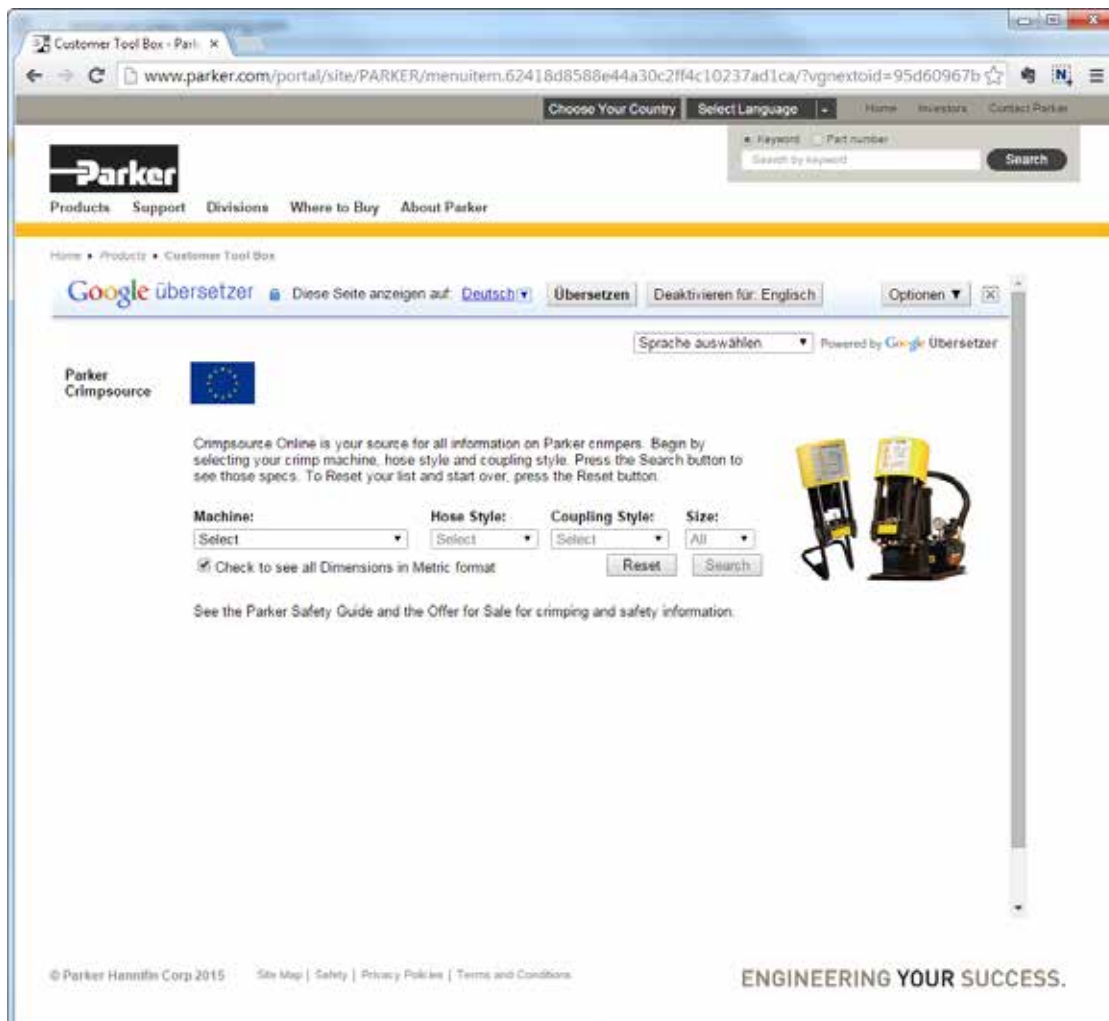

Find the correct crimp specification on the push of a button!

www.parker.com/crimpsource-euro

Catalogue 4400/UK

Part Number Index

Part Number	Page	Part Number	Page	Part Number	Page	Part Number	Page
201	B2a-1	10677	Dd-8	19270	Db-5	15T26	B2b-7
206	B2a-2	10826	B2b-4	19273	Dc-5	16A43	Cb-12
213	B2a-3	10846	Cc-22	30182	B1b-11	16A46	Cc-28
244	B2a-5	10848	Cc-22	30282	B1b-11	16A48	Cc-28
285	B2a-6	11543	Cb-11	30382	B1b-12	16A70	Db-12
293	B2a-7	11546	Cc-25	30682	B1b-12	16A73	Dc-11
304	Cab-5	11548	Cc-25	30882	B1b-13	16A77	Dd-13
372	Dab-2	11570	Db-11	33482	B1b-10	16F46	Cc-28
412	Cab-6	11573	Dc-10	33782	B1b-13	16F48	Cc-28
426	Cab-12	11577	Dd-10	33982	B1b-14	16F70	Db-13
436	Cab-13	11743	Cb-11	34982	B1b-6	16F73	Dc-12
441	Cab-14	11746	Cc-26	38282	B1b-17	16F77	Dd-14
462	Cab-17	11748	Cc-26	39182	B1b-10	16N43	Cb-13
463	Cab-22	11770	Db-11	39282	B1b-8	16N46	Cc-29
477	Cab-24	11773	Dc-10	711509	Eb-7	16N48	Cc-29
492	Cab-28	11777	Dd-11	853009	Eb-6	16N70	Db-13
493	Cab-31	11943	Cb-12	16E73	Dc-12	16N73	Dc-13
681	B2a-9	11946	Cc-27	16E77	Dd-14	16N77	Dd-15
692	Cab-32	11948	Cc-27	100IF	Ce-1	1B143	Cb-5
701	Dab-11	11970	Db-12	100V5	Df-24	1B146	Cc-11
722	Daa-1	11973	Dc-11	100VS	De-1	1B148	Cc-11
731	Dab-13	11977	Dd-12	100WB	Dh-1	1B170	Db-5
774	Dab-15	13726	B2b-4	10C43	Cb-3	1B173	Dc-5
787	Daa-4	13743	Cb-10	10C46	Cc-6	1B243	Cb-6
797	Daa-7	13746	Cc-22	10C48	Cc-6	1B246	Cc-12
804	B1a-3	13748	Cc-22	10C70	Db-3	1B248	Cc-12
811	Cab-37	13770	Db-10	10C73	Dc-3	1B270	Db-6
836	B1a-6	13773	Dc-8	10C77	Dd-3	1B273	Dc-6
846	B1a-10	13777	Dd-9	11C43	Cb-4	1B446	Cc-13
881	Cab-39	13926	B2b-5	11C46	Cc-7	1B448	Cc-13
10048	Cd-1	13943	Cb-10	11C48	Cc-7	1B546	Cc-18
10126	B2b-3	13946	Cc-23	11C70	Db-4	1B548	Cc-18
10146	Cc-19	13948	Cc-23	11C73	Dc-3	1C943	Cb-3
10148	Cc-19	13970	Db-10	11C77	Dd-4	1C946	Cc-5
10170	Db-8	13973	Dc-9	13V26	B2b-4	1C948	Cc-5
10173	Dc-7	13977	Dd-9	13V46	Cc-22	1C970	Db-3
10177	Dd-7	14146	Cc-24	13V48	Cc-22	1C973	Dc-2
10343	Cb-9	14148	Cc-24	13W46	Cc-23	1C977	Dd-3
10346	Cc-20	14926	B2b-2	13W48	Cc-23	1CA26	B2b-1
10348	Cc-20	14946	Cc-9	13W70	Db-10	1CA43	Cb-1
10370	Db-8	14948	Cc-9	13Y46	Cc-24	1CA46	Cc-1
10373	Dc-7	16826	B2b-3	13Y48	Cc-24	1CA48	Cc-1
10377	Dd-7	16846	Cc-21	14A73	Dc-10	1CA70	Db-1
10626	B2b-3	16848	Cc-21	14A77	Dd-10	1CA73	Dc-1
10643	Cb-9	19146	Cc-18	14F73	Dc-10	1CA77	Dd-1
10646	Cc-21	19148	Cc-18	14F77	Dd-11	1CE26	B2b-1
10648	Cc-21	19243	Cb-5	14N73	Dc-11	1CE43	Cb-1
10670	Db-9	19246	Cc-10	14N77	Dd-12	1CE46	Cc-2
10673	Dc-8	19248	Cc-10	15S26	B2b-7	1CE48	Cc-2

Catalogue 4400/UK

Part Number Index

Part Number	Page	Part Number	Page	Part Number	Page	Part Number	Page
1CE70	Db-1	1FG77	Dd-24	1PW46	Cc-39	462PU	Cab-18
1CE73	Dc-1	1FU46	Cc-36	1PW48	Cc-39	462PU Twin	Cab-19
1CE77	Dd-1	1FU48	Cc-36	1PY70	Db-14	462ST	Cab-21
1CF26	B2b-2	1GU46	Cc-36	1X577	Dd-16	462TC	Cab-20
1CF43	Cb-2	1GU48	Cc-36	1X777	Dd-16	471TC	Cab-23
1CF46	Cc-3	1J146	Cc-34	1X977	Dd-17	477RH	Cab-25
1CF48	Cc-3	1J148	Cc-34	1XA73	Dc-13	477ST	Cab-27
1CF70	Db-2	1J170	Db-17	1XA77	Dd-17	477TC	Cab-26
1CF73	Dc-2	1J177	Dd-22	1XF73	Dc-14	492ST	Cab-30
1CF77	Dd-2	1J546	Cc-34	1XF77	Dd-18	492TC	Cab-29
1CW46	Cc-38	1J548	Cc-34	1XG73	Dc-14	611HT	B2a-8
1CW48	Cc-38	1J743	Cb-15	1XG77	Dd-18	681DB	B2a-10
1D043	Cb-2	1J746	Cc-32	1XN73	Dc-15	692PU	Cab-34
1D046	Cc-4	1J748	Cc-32	1XN77	Dd-19	692PU Twin	Cab-35
1D048	Cc-4	1J770	Db-16	1XU46	Cc-40	692TC	Cab-36
1D070	Db-2	1J773	Dc-17	1XU48	Cc-40	692Twin	Cab-33
1D077	Dd-2	1J777	Dd-21	1XU70	Db-18	701TC	Dab-12
1D243	Cb-4	1J943	Cb-15	1XU73	Dc-19	722ST	Daa-3
1D246	Cc-8	1J946	Cc-33	1XY70	Db-18	722TC	Daa-2
1D248	Cc-8	1J948	Cc-33	221FR	B2a-4	731TC	Dab-14
1D270	Db-4	1J970	Db-16	301SN	Cab-4	787ST	Daa-6
1D273	Dc-4	1J973	Dc-17	35C82	B1b-17	787TC	Daa-5
1D277	Dd-4	1J977	Dd-22	36C82	B1b-18	797RH	Dab-16
1D943	Cb-8	1JC26	B2b-6	371LT	Dab-1	797ST	Daa-9
1D946	Cc-17	1JC43	Cb-14	372RH	Dab-3	797TC	Daa-8
1D948	Cc-17	1JC46	Cc-30	372TC	Dab-4	801PLUS	B1a-1
1D970	Db-7	1JC48	Cc-30	37C82	B1b-18	801RH	B1a-2
1D973	Dc-6	1JC70	Db-15	39B82	B1b-6	80C-ODR	Ea-6
1D977	Dd-6	1JC73	Dc-16	39C82	B1b-7	80C-A04	Ea-6
1EA43	Cb-6	1JC77	Dd-21	3AF82	B1b-16	80C-A05	Ea-6
1EA46	Cc-14	1JD46	Cc-35	3B182	B1b-8	80C-A06	Ea-6
1EA48	Cc-14	1JD48	Cc-35	3B282	B1b-9	80C-A08	Ea-6
1EA70	Db-6	1JM46	Cc-35	3C382	B1b-3	80C-A10	Ea-6
1EA77	Dd-5	1JM48	Cc-35	3C482	B1b-4	80C-A12	Ea-6
1EB43	Cb-7	1JM70	Db-17	3C582	B1b-5	80C-A16	Ea-6
1EB46	Cc-15	1JM73	Dc-18	3CA82	B1b-1	80C-A20	Ea-6
1EB48	Cc-15	1JM77	Dd-23	3CE82	B1b-1	80C-B04	Ea-6
1EB77	Dd-5	1JS43	Cb-14	3CF82	B1b-2	80C-B05	Ea-6
1EC43	Cb-7	1JS46	Cc-31	3D082	B1b-2	80C-B06	Ea-6
1EC46	Cc-16	1JS48	Cc-31	3D982	B1b-9	80C-B08	Ea-6
1EC48	Cc-16	1JS70	Db-15	3FF82	B1b-16	80C-B10	Ea-6
1EC70	Db-7	1JS73	Dc-16	3JC82	B1b-15	80C-B12	Ea-6
1EC77	Dd-6	1K577	Dd-19	412ST	Cab-7	80C-B16	Ea-6
1EN46	Cc-41	1K777	Dd-20	421RH	Cab-8	80C-B20	Ea-6
1EN48	Cc-41	1K977	Dd-20	421SN	Cab-9	80C-C04	Ea-6
1ET46	Cc-42	1MZ46	Cc-37	421TC	Cab-10	80C-C05	Ea-6
1ET48	Cc-42	1MZ48	Cc-37	421WC	Cab-11	80C-C06	Ea-6
1EU46	Cc-41	1NW46	Cc-38	441RH	Cab-15	80C-C08	Ea-6
1EU48	Cc-41	1NW48	Cc-38	461LT	Cab-16	80C-C10	Ea-6

Catalogue 4400/UK

Part Number Index

Part Number	Page	Part Number	Page	Part Number	Page	Part Number	Page
80C-C12	Ea-6	83C-E24	Ea-6	H899770	Ea-19	K3VVS	De-9
80C-C16	Ea-6	83C-E32	Ea-6	H899771	Ea-15	K3WVS	De-10
80C-C20	Ea-6	83C-L12	Ea-6	H899959	Ea-15	K4AV4	Df-12
80C-CS08	Ea-6	83C-L16	Ea-6	H905375	Eb-23	K4AV6	Df-12
80C-CS10	Ea-6	83C-L20	Ea-6	HG	Eb-18	K4FV4	Df-13
80C-CS12	Ea-6	83C-L24	Ea-6	Hoze-Oil	Eb-24	K4FV6	Df-13
80C-E04	Ea-6	83C-L32	Ea-6	HP-B	Eb-21	K4NV4	Df-14
80C-E05	Ea-6	83C-R02	Ea-4	HS	Eb-23	K4NV6	Df-14
80C-E06	Ea-6	83C-R02H	Ea-4	HT2	Cab-3	K68VS	De-9
80C-E08	Ea-6	85C-00L	Ea-1	K0147	Cd-1	K6AV4	Df-15
80C-E10	Ea-6	85C-00L	Ea-2	K01V4	Df-9	K6AV6	Df-15
80C-E12	Ea-6	85C-00L	Ea-5	K01V6	Df-9	K6AVS	De-12
80C-E16	Ea-6	85C-0AP	Ea-5	K01VS	De-8	K6FV4	Df-16
80C-L12	Ea-6	85CE-061L	Ea-2	K01WB	Dh-4	K6FV6	Df-16
80C-L16	Ea-6	85CE-0HP	Ea-5	K03V4	Df-9	K6FVS	De-13
811S	Cab-38	85CE-1PE	Ea-3	K03V6	Df-9	K6NV4	Df-17
821FR	B1a-4	85CE-1PE	Ea-5	K03VS	De-8	K6NV6	Df-17
82C-2HP	Ea-5	85CE-XAM	Ea-5	K06V4	Df-10	K6NVS	De-13
82CE-00L	Ea-5	85C-R01	Ea-2	K06V6	Df-10	K8AV4	Df-18
82CE-061L	Ea-1	85C-R02	Ea-2	K06VS	De-9	K8AV6	Df-18
82CE-0EP	Ea-5	85C-STD	Ea-1	K0CV4	Df-4	K8FV4	Df-18
82CE-CHD	Ea-1	85C-STD	Ea-2	K0CV5	Dg-2	K8FV6	Df-18
82C-R01	Ea-1	8FH	Eb-1	K0CV6	Df-4	K8NV4	Df-19
82C-R02	Ea-1	AG	Eb-13	K0CVS	De-4	K8NV6	Df-19
830M	B1a-5	AM	Eb-6	K1547	Cd-2	K91V4	Df-8
837BM	B1a-7	AR	Eb-6	K15IF	Ce-2	K92V4	Df-6
837PU	B1a-8	AS-B	Eb-14	K15V4	Df-12	K92V6	Df-6
838M	B1a-9	AS-Y	Eb-14	K15V6	Df-12	K92VS	De-6
83C-0CB	Ea-4	BCH1	Cab-1	K15VS	De-11	K92WB	Dh-3
83C-0DR	Ea-6	BCH2	Cab-2	K1747	Cd-2	KB1V4	Df-6
83C-A16H	Ea-6	BPK	Dab-30	K17IF	Ce-2	KB1V6	Df-6
83C-A20H	Ea-6	C9RG	Eb-7	K17V4	Df-13	KB1VS	De-6
83C-A24	Ea-6	CARG	Eb-8	K17V6	Df-13	KB2V4	Df-7
83C-A32	Ea-6	CEM69TC	Dab-33	K17VS	De-11	KB2V6	Df-7
83C-C20H	Ea-6	DMS	Eb-16	K1947	Cd-2	KB2VS	De-7
83C-C24	Ea-6	EARG	Eb-7	K19IF	Ce-3	KC9V4	Df-3
83C-C32	Ea-6	EM10.P	Ea-7	K19V4	Df-14	KC9V5	Dg-2
83C-CS16	Ea-6	F42	Dab-17	K19V6	Df-14	KC9V6	Df-3
83C-CS20	Ea-6	FA35	Dab-31	K19VS	De-12	KC9VS	De-4
83C-CS24	Ea-6	FS-F	Eb-17	K1CV4	Df-4	KC9WB	Dh-2
83C-CS32	Ea-6	FU-HMX	Ea-24	K1CV5	Dg-3	KCAV4	Df-2
83C-D06	Ea-6	FU-HMX	Ea-25	K1CV6	Df-4	KCAV6	Df-2
83C-D08	Ea-6	H29	Dab-18	K1CVS	De-5	KCAVS	De-2
83C-D10	Ea-6	H29ST	Dab-20	K37V4	Df-10	KCEV4	Df-2
83C-D12	Ea-6	H29TC	Dab-19	K37V6	Df-10	KCEV6	Df-2
83C-D16	Ea-6	H31	Dab-21	K37VS	De-9	KCEVS	De-2
83C-D16H	Ea-6	H31ST	Dab-23	K39V4	Df-11	KCFV4	Df-3
83CE-083U	Ea-4	H31TC	Dab-22	K39V6	Df-11	KCFV6	Df-3
83C-E20	Ea-6	H896137	Eb-24	K39VS	De-10	KCFVS	De-3

Catalogue 4400/UK

Part Number Index

Part Number	Page	Part Number	Page	Part Number	Page	Part Number	Page
KD0VS	De-3	PG	Eb-19	TH2-11M-8	Ea-30	TH6-10-H06	Ea-18
KD2V4	Df-5	PS-B	Eb-15	TH2-12NK-1012	Ea-30	TH6-10-H08	Ea-17
KD2V6	Df-5	PS-BV	Eb-20	TH2-12NK-1620	Ea-30	TH6-10-H08	Ea-18
KD2VS	De-5	QDC239.3	Ea-22	TH2-12NK-2432	Ea-30	TH6-10-H10	Ea-17
KD9V4	Df-7	QDC239.5	Ea-23	TH2-12NK-6	Ea-30	TH6-10-H10	Ea-18
KD9V6	Df-7	QDC239.5	Ea-24	TH2-12NK-8	Ea-30	TH6-10-H13	Ea-17
KD9VS	De-7	QDC239.5	Ea-25	TH2-12NT-10	Ea-30	TH6-10-H13	Ea-18
KJ7V4	Df-24	QDC239.5	Ea-26	TH2-12NT-12	Ea-30	TH6-10-H16	Ea-17
KJ7V6	Df-24	QDS239S	Ea-24	TH2-12NT-16	Ea-30	TH6-10-H16	Ea-18
KJ7VS	De-14	QDS239S	Ea-24	TH2-12NT-20	Ea-30	TH6-10-H19	Ea-17
KJ9V4	Df-24	QDS239S	Ea-25	TH2-12NT-24	Ea-30	TH6-10-H19	Ea-18
KJ9V6	Dg-1	R-__CFX	Eb-4	TH2-12NT-32	Ea-30	TH6-10-H25	Ea-17
KJ9VS	De-15	R35	Dab-24	TH2-12NT-6	Ea-30	TH6-10-H25	Ea-18
KJCV4	Df-23	R35TC/RS35TC-48	Dab-25	TH2-12-NT-6	Ea-30	TH6-10-H32	Ea-17
KJCV6	Df-23	R42	Dab-26	TH2-12NT-8	Ea-30	TH6-10-H32	Ea-18
KJCVS	De-14	R42ST	Dab-28	TH2-12-NT-8	Ea-30	TH6-10-H38	Ea-18
KJMV4	Df-25	R42TC	Dab-27	TH2-13-3PH	Ea-29	TH6-10-H50	Ea-18
KJSV4	Df-23	R50TC/R56TC	Dab-29	TH2-13EL-1	Ea-30	TH6-10-HL-10-2	Ea-18
KV4V4	Df-1	RD35TC	Dab-32	TH2-13ES-1	Ea-30	TH6-10-P10	Ea-17
KV4V6	Df-1	S__	Eb-10	TH2-13ET	Ea-30	TH6-10-P10	Ea-18
KV5V5	Dg-1	SG	Eb-12	TH2-13M-10	Ea-30	TH6-10-P12	Ea-17
KV6V4	Df-1	SHS310/370	Ea-24	TH2-13M-12	Ea-30	TH6-10-P12	Ea-18
KV6V6	Df-1	SHS375-380	Ea-25	TH2-13M-16	Ea-30	TH6-10-P14	Ea-17
KX5V6	Df-19	SHS-800	Ea-24	TH2-13M-20	Ea-30	TH6-10-P14	Ea-18
KX7V6	Df-20	SS__N	Eb-10	TH2-13M-24	Ea-30	TH6-10-P18	Ea-17
KX9V6	Df-20	SX35	Dab-5	TH2-13M-32	Ea-30	TH6-10-P18	Ea-18
KXAV4	Df-21	SX35LT	Dab-6	TH2-13M-8	Ea-30	TH6-10-P22	Ea-17
KXAV6	Df-21	SX35TC	Dab-7	TH2-9-1PE	Ea-27	TH6-10-P22	Ea-18
KXV4	Df-21	SX42	Dab-8	TH2-9-3PH	Ea-27	TH6-10-P26	Ea-17
KXV6	Df-21	SX42LT	Dab-9	TH3-2-12VDC	Ea-8	TH6-10-P26	Ea-18
KXGV4	Df-22	SX42TC	Dab-10	TH3E-110	Ea-12	TH6-10-P33	Ea-17
KXGV6	Df-22	TA1E-5	Ea-33	TH3E-115	Ea-11	TH6-10-P33	Ea-18
KXNV4	Df-22	TA380/A	Ea-25	TH3E-EM3	Ea-9	TH6-10-P40	Ea-17
KXNV6	Df-22	TA800/A	Ea-24	TH3E-EM6-M	Ea-10	TH6-10-P40	Ea-18
M__	Eb-9	TH11-3	Eb-24	TH3E-EM6-P	Ea-10	TH6-10-P50	Ea-18
M1H	Eb-1	TH2-10-3PH	Ea-28	TH4-10	Ea-13	TH6-10-P60	Ea-18
M2H	Eb-1	TH2-11EK	Ea-30	TH4-4U	Ea-14	TH6-6	Ea-15
MS__N	Eb-9	TH2-11EL	Ea-30	TH4-7	Ea-13	TH6-7	Ea-16
PB237.239.2L2	Ea-24	TH2-11EL-1	Ea-30	TH4-8	Ea-13	TH6-7-30	Ea-16
PB237.239.2L2	Ea-25	TH2-11ES	Ea-30	TH4-9	Ea-13	TH6-7-55	Ea-16
PB237.239.2L2	Ea-26	TH2-11ES-1	Ea-30	TH4-9-1	Ea-13	TH7-12	Ea-20
PB245.237L	Ea-26	TH2-11M-10	Ea-30	TH4E-11	Ea-14	TH7-13	Ea-20
PB266.239L	Ea-23	TH2-11M-12	Ea-30	TH4E-11-TC	Ea-14	TH7-14	Ea-21
PBSET-237L-IH	Ea-25	TH2-11M-16	Ea-30	TH4E-11-TH	Ea-14	TH7-15	Ea-21
PBSET-TH8-800	Ea-24	TH2-11M-20	Ea-30	TH5-3	Ea-19	TH8E-200	Ea-22
PBSET-TH8E-200	Ea-22	TH2-11M-24	Ea-30	TH5-3-BM	Ea-19	TH8E-200-24VDC	Ea-22
PBSET-TH8E-380	Ea-25	TH2-11M-32	Ea-30	TH5-3-CM	Ea-19	TH8E-200-ECO	Ea-22
PBSET-TH8E-53X	Ea-23	TH2-11M-4	Ea-30	TH6-10-EL-8	Ea-17	TH8E-200VDC	Ea-22
PCS-	Ea-31	TH2-11M-6	Ea-30	TH6-10-H06	Ea-17	TH8E-380-CM	Ea-25

Catalogue 4400/UK

Part Number Index

Part Number	Page
TH8E-480-CM	Ea-26
TH8E-530	Ea-23
TH8E-530-CM	Ea-23
TH8E-535-CM	Ea-23
TH8E-800	Ea-24
TH8E-800-CM	Ea-24
TH8-LUS	Ea-25
TH8-LUS	Ea-26
TM160x2,5x20	Ea-7
TM250x2x40Z	Ea-8
TMG275x3x30	Ea-9
TMG350x3x30	Ea-10
TMG520x4x120	Ea-12
TMG520x4x40	Ea-11
UC-1.5HD	Ea-32
UC-CSS-230VE	Ea-32
UC-HG-STAND	Ea-32
UC-HL191OE-EU	Ea-32
UNC__	Eb-2
UNC__	Eb-5
UPTH-11b-PW3	Ea-14
UPTH-22b	Ea-14
UPTS100	Ea-14
VERG	Eb-7
VURG	Eb-7
WKS	Eb-20
WRA	Eb-22
WRC	Eb-22
WRF	Eb-22
XARG	Eb-8
ZYLS__VZX	Eb-2
ZYLS__VZX	Eb-3
ZYLS__VZX	Eb-5

Parker's Motion & Control Technologies

At Parker, we're guided by a relentless drive to help our customers become more productive and achieve higher levels of profitability by engineering the best systems for their requirements. It means looking at customer applications from many angles to find new ways to create value. Whatever the motion and control technology need, Parker has the experience, breadth of product and global reach to consistently deliver. No company knows more about motion and control technology than Parker.

**For further info call
00800 27 27 5374**



Aerospace

Key Markets

Aftermarket services
Commercial transports
Engines
General & business aviation
Helicopters
Launch vehicles
Military aircraft
Missiles
Power generation
Regional transports
Unmanned aerial vehicles

Key Products

Control systems & actuation products
Engine systems & components
Fluid conveyance systems & components
Fluid metering, delivery & atomization devices
Fuel systems & components
Fuel tank inerting systems
Hydraulic systems & components
Thermal management
Wheels & brakes



Climate Control

Key Markets

Agriculture
Air conditioning
Construction Machinery
Food & beverage
Industrial machinery
Life sciences
Oil & gas
Precision cooling
Process
Refrigeration
Transportation

Key Products

Accumulators
Advanced actuators
CO₂ controls
Electronic controllers
Filter driers
Hand shut-off valves
Heat exchangers
Hose & fittings
Pressure regulating valves
Refrigerant distributors
Safety relief valves
Smart pumps
Solenoid valves
Thermostatic expansion valves



Hydraulics

Key Markets

Aerial lift
Agriculture
Alternative energy
Construction machinery
Forestry
Industrial machinery
Machine tools
Marine
Material handling
Mining
Oil & gas
Power generation
Refuse vehicles
Renewable energy
Truck hydraulics
Turf equipment

Key Products

Accumulators
Cartridge valves
Electrohydraulic actuators
Human machine interfaces
Hybrid drives
Hydraulic cylinders
Hydraulic motors & pumps
Hydraulic systems
Hydraulic valves & controls
Hydrostatic steering
Integrated hydraulic circuits
Power take-offs
Power units
Rotary actuators
Sensors



Pneumatics

Key Markets

Aerospace
Conveyor & material handling
Factory automation
Life science & medical
Machine tools
Packaging machinery
Transportation & automotive

Key Products

Air preparation
Brass fittings & valves
Manifolds
Pneumatic accessories
Pneumatic actuators & grippers
Pneumatic valves & controls
Quick disconnects
Rotary actuators
Rubber & thermoplastic hose & couplings
Structural extrusions
Thermoplastic tubing & fittings
Vacuum generators, cups & sensors





Electromechanical

Key Markets

Aerospace
 Factory automation
 Life science & medical
 Machine tools
 Packaging machinery
 Paper machinery
 Plastics machinery & converting
 Primary metals
 Semiconductor & electronics
 Textile
 Wire & cable

Key Products

AC/DC drives & systems
 Electric actuators, gantry robots & slides
 Electrohydraulic actuation systems
 Electromechanical actuation systems
 Human machine interface
 Linear motors
 Stepper motors, servo motors, drives & controls
 Structural extrusions



Filtration

Key Markets

Aerospace
 Food & beverage
 Industrial plant & equipment
 Life sciences
 Marine
 Mobile equipment
 Oil & gas
 Power generation & renewable energy
 Process
 Transportation
 Water Purification

Key Products

Analytical gas generators
 Compressed air filters & dryers
 Engine air, coolant, fuel & oil filtration systems
 Fluid condition monitoring systems
 Hydraulic & lubrication filters
 Hydrogen, nitrogen & zero air generators
 Instrumentation filters
 Membrane & fiber filters
 Microfiltration
 Sterile air filtration
 Water desalination & purification filters & systems



Fluid & Gas Handling

Key Markets

Aerial lift
 Agriculture
 Bulk chemical handling
 Construction machinery
 Food & beverage
 Fuel & gas delivery
 Industrial machinery
 Life sciences
 Marine
 Mining
 Mobile
 Oil & gas
 Renewable energy
 Transportation

Key Products

Check valves
 Connectors for low pressure fluid conveyance
 Deep sea umbilicals
 Diagnostic equipment
 Hose couplings
 Industrial hose
 Mooring systems & power cables
 PTFE hose & tubing
 Quick couplings
 Rubber & thermoplastic hose
 Tube fittings & adapters
 Tubing & plastic fittings



Process Control

Key Markets

Alternative fuels
 Biopharmaceuticals
 Chemical & refining
 Food & beverage
 Marine & shipbuilding
 Medical & dental
 Microelectronics
 Nuclear Power
 Offshore oil exploration
 Oil & gas
 Pharmaceuticals
 Power generation
 Pulp & paper
 Steel
 Water/wastewater

Key Products

Analytical Instruments
 Analytical sample conditioning products & systems
 Chemical injection fittings & valves
 Fluoropolymer chemical delivery fittings, valves & pumps
 High purity gas delivery fittings, valves, regulators & digital flow controllers
 Industrial mass flow meters/controllers
 Permanent no-weld tube fittings
 Precision industrial regulators & flow controllers
 Process control double block & bleeds
 Process control fittings, valves, regulators & manifold valves



Sealing & Shielding

Key Markets

Aerospace
 Chemical processing
 Consumer
 Fluid power
 General industrial
 Information technology
 Life sciences
 Microelectronics
 Military
 Oil & gas
 Power generation
 Renewable energy
 Telecommunications
 Transportation

Key Products

Dynamic seals
 Elastomeric o-rings
 Electro-medical instrument design & assembly
 EMI shielding
 Extruded & precision-cut, fabricated elastomeric seals
 High temperature metal seals
 Homogeneous & inserted elastomeric shapes
 Medical device fabrication & assembly
 Metal & plastic retained composite seals
 Shielded optical windows
 Silicone tubing & extrusions
 Thermal management
 Vibration dampening

ENGINEERING YOUR SUCCESS.

Parker Worldwide

Europe, Middle East, Africa

AE – United Arab Emirates, Dubai

Tel: +971 4 8127100
parker.me@parker.com

AT – Austria, St. Florian

Tel: +43 (0)7224 66201
parker.austria@parker.com

AZ – Azerbaijan, Baku

Tel: +994 50 2233 458
parker.azerbaijan@parker.com

BE/NL/LU – Benelux,

Hendrik Ido Ambacht
Tel: +31 (0)541 585 000
parker.nl@parker.com

BG – Bulgaria, Sofia

Tel: +359 2 980 1344
parker.bulgaria@parker.com

BY – Belarus, Minsk

Tel: +48 (0)22 573 24 00
parker.poland@parker.com

CH – Switzerland, Etoy

Tel: +41 (0)21 821 87 00
parker.switzerland@parker.com

CZ – Czech Republic, Klecany

Tel: +420 284 083 111
parker.czechrepublic@parker.com

DE – Germany, Kaarst

Tel: +49 (0)2131 4016 0
parker.germany@parker.com

DK – Denmark, Ballerup

Tel: +45 43 56 04 00
parker.denmark@parker.com

ES – Spain, Madrid

Tel: +34 902 330 001
parker.spain@parker.com

FI – Finland, Vantaa

Tel: +358 (0)20 753 2500
parker.finland@parker.com

FR – France, Contamine s/Arve

Tel: +33 (0)4 50 25 80 25
parker.france@parker.com

GR – Greece, Piraeus

Tel: +30 210 933 6450
parker.greece@parker.com

HU – Hungary, Budaörs

Tel: +36 23 885 470
parker.hungary@parker.com

IE – Ireland, Dublin

Tel: +353 (0)1 466 6370
parker.ireland@parker.com

IL – Israel

Tel: +39 02 45 19 21
parker.israel@parker.com

IT – Italy, Corsico (MI)

Tel: +39 02 45 19 21
parker.italy@parker.com

KZ – Kazakhstan, Almaty

Tel: +7 7273 561 000
parker.easteurope@parker.com

NO – Norway, Asker

Tel: +47 66 75 34 00
parker.norway@parker.com

PL – Poland, Warsaw

Tel: +48 (0)22 573 24 00
parker.poland@parker.com

PT – Portugal

Tel: +351 22 999 7360
parker.portugal@parker.com

RO – Romania, Bucharest

Tel: +40 21 252 1382
parker.romania@parker.com

RU – Russia, Moscow

Tel: +7 495 645-2156
parker.russia@parker.com

SE – Sweden, Spånga

Tel: +46 (0)8 59 79 50 00
parker.sweden@parker.com

SK – Slovakia, Banská Bystrica

Tel: +421 484 162 252
parker.slovakia@parker.com

SL – Slovenia, Novo Mesto

Tel: +386 7 337 6650
parker.slovenia@parker.com

TR – Turkey, Istanbul

Tel: +90 216 4997081
parker.turkey@parker.com

UA – Ukraine, Kiev

Tel: +48 (0)22 573 24 00
parker.poland@parker.com

UK – United Kingdom, Warwick

Tel: +44 (0)1926 317 878
parker.uk@parker.com

ZA – South Africa, Kempton Park

Tel: +27 (0)11 961 0700
parker.southafrica@parker.com

North America

CA – Canada, Milton, Ontario

Tel: +1 905 693 3000

US – USA, Cleveland

Tel: +1 216 896 3000

Asia Pacific

AU – Australia, Castle Hill

Tel: +61 (0)2-9634 7777

CN – China, Shanghai

Tel: +86 21 2899 5000

HK – Hong Kong

Tel: +852 2428 8008

IN – India, Mumbai

Tel: +91 22 6513 7081-85

JP – Japan, Tokyo

Tel: +81 (0)3 6408 3901

KR – South Korea, Seoul

Tel: +82 2 559 0400

MY – Malaysia, Shah Alam

Tel: +60 3 7849 0800

NZ – New Zealand, Mt Wellington

Tel: +64 9 574 1744

SG – Singapore

Tel: +65 6887 6300

TH – Thailand, Bangkok

Tel: +662 186 7000

TW – Taiwan, Taipei

Tel: +886 2 2298 8987

South America

AR – Argentina, Buenos Aires

Tel: +54 3327 44 4129

BR – Brazil, Sao Jose dos Campos

Tel: +55 800 727 5374

CL – Chile, Santiago

Tel: +56 2 623 1216

MX – Mexico, Toluca

Tel: +52 72 2275 4200

European Product Information Centre

Free phone: 00 800 27 27 5374

(from AT, BE, CH, CZ, DE, DK, EE, ES, FI,
FR, IE, IL, IS, IT, LU, MT, NL, NO, PL, PT, RU,
SE, SK, UK, ZA)



Parker Hannifin Ltd.

Tachbrook Park Drive
Tachbrook Park,
Warwick, CV34 6TU
United Kingdom
Tel.: +44 (0) 1926 317 878
Fax: +44 (0) 1926 317 855
parker.uk@parker.com
www.parker.com